



C138 – Liverpool Street Station

Static Analysis and Dynamic Passenger Modelling – Stage E Report

Document Number: C138-MMD-A-RGN-C101-50002

Document History:

| Revision: | Date: | Prepared by: | Checked by: | Approved by: | Reason for Issue: |
|-----------|------------|--------------------------|--------------------------|--------------------------|--|
| 1.0 | 08/03/2011 | [REDACTED] | [REDACTED] | [REDACTED] | Issue for review, |
| 2.0 | 10/06/2011 | [REDACTED] | [REDACTED] | [REDACTED] | Review comments incorporated |
| 3.0 | 11/08/2011 | [REDACTED] | [REDACTED] | [REDACTED] | Additional LU review comments incorporated – C502 ITT Submission |
| 4.0 | 25/10/2011 | [REDACTED] [REDACTED] | [REDACTED] [REDACTED] | [REDACTED] [REDACTED] | C502 ITT Addendum |

| CROSSRAIL CENTRAL (PDP) REVIEW AND ACCEPTANCE STATUS | |
|---|---|
| This decal is to be used for submitted documents requiring acceptance by Crossrail Central. | |
| <input checked="" type="checkbox"/> | Code 1. Accepted. Work May Proceed |
| <input type="checkbox"/> | Code 2. Not Accepted. Revise and resubmit. Work may proceed subject to incorporation of changes indicated |
| <input type="checkbox"/> | Code 3. Not Accepted. Revise and resubmit. Work may not proceed |
| <input type="checkbox"/> | Code 4. Received for information only. Receipt is confirmed |
| Reviewed/Accepted by:(signature) | [REDACTED] |
| Print Name: | [REDACTED] Date: 25 / 10 / 2011 |
| Acceptance by Crossrail Central does not relieve the designer/supplier from full compliance with their contractual obligations and does not constitute Crossrail Central approval of design, details, calculations, analyses, test methods or materials developed or selected by the designer/supplier. | |

This document contains proprietary information. No part of this document may be reproduced without prior written consent from the chief executive of Crossrail Ltd.



Mott MacDonald Issue and Revision Record

Document Title: Static Analysis and Dynamic Passenger Modelling – Stage E Report

Document number: C138-MMD-A-RGN-C101-50002

Design Team

| Rev | Date | Originator | Checker | Approver | Description |
|-----|------------|------------|------------|------------|--|
| 1.0 | 08/03/2011 | [REDACTED] | [REDACTED] | [REDACTED] | Issue for review. |
| 2.0 | 10/06/2011 | [REDACTED] | [REDACTED] | [REDACTED] | Review comments incorporated |
| 3.0 | 11/08/2011 | [REDACTED] | [REDACTED] | [REDACTED] | Additional LU review comments incorporated – C502 ITT Submission |
| 4.0 | 25/10/2011 | [REDACTED] | [REDACTED] | [REDACTED] | C502 ITT Addendum |

Subject to the terms of the contract between Crossrail and Mott MacDonald Limited:

This document is issued for the party which commissioned it and for specific purposes connected with the Crossrail project only;

It should not be relied upon by any other party, unless the contrary intention is expressly stated in the contract, or used for any other purpose;

We accept no responsibility for the consequences of this document being relied upon by any other party, or being used for any other purpose;

This document contains confidential information and proprietary intellectual property. It should not be shown to other parties without consent from either Mott MacDonald Limited or from the party which commissioned it, Crossrail Limited or Crossrail Central.

Contents

| | |
|--|-----------|
| Executive Summary | 5 |
| 1 Background and Purpose..... | 8 |
| 2 Scope | 8 |
| 3 Static Analysis..... | 11 |
| 3.1 Assumptions | 11 |
| 3.2 Results | 11 |
| 3.3 Summary of Static Analysis..... | 14 |
| 3.4 Summary of Mitigations to Non – Compliances..... | 15 |
| 3.4.1 The unpaid side of the new Moorgate Integrated ticket hall concourse | 15 |
| 3.4.2 The new stairs connecting the Moorgate Integrated ticket hall to the Metropolitan Line westbound platform:..... | 16 |
| 3.4.3 The existing stairs connecting the Moorgate Integrated ticket hall to the Metropolitan Line eastbound platform | 18 |
| 3.4.4 The new stairs connecting the NLL (AP6) and the Northern Line platforms | 20 |
| 4 Dynamic Modelling..... | 24 |
| 4.1 Background Information | 24 |
| 4.2 Key Changes to Legion models following the LU Audit | 24 |
| 4.2.1 Crossrail eastbound boarding distribution assumption | 24 |
| 4.2.2 Alteration to lift logic and changes to PRM routing..... | 25 |
| 4.2.3 Moorgate ticket hall – escalators and gate-line operation | 25 |
| 4.3 Modelling Scenarios and Base Model Files..... | 25 |
| 4.4 Assessment Criteria | 26 |
| 4.5 Modelling Output..... | 26 |
| 4.5.1 Moorgate Integrated Ticket Hall | 27 |
| 4.5.2 Northern Line Link (AP6) | 29 |
| 4.5.3 New stairs between the NLL (AP6) and Northern Line platforms | 30 |
| 4.5.4 Existing Northern Line Platforms | 31 |
| 4.5.5 Existing Moorgate Ticket Hall | 32 |
| 4.5.6 Existing FCC Platforms..... | 33 |
| 4.5.7 Crossrail Platforms (Non-Cancelled Train)..... | 35 |
| 4.5.8 Crossrail Platform Adits and Central Concourse (Non-Cancelled Train) | 38 |
| 4.5.9 Passageways AP2 and AP9..... | 38 |



| | | |
|--------|---|----|
| 4.5.10 | Broadgate Ticket Hall, Access Passageway AP8, and the existing Liverpool St Ticket Hall B | 38 |
| 4.6 | Cancelled Crossrail Train – Additional Sensitivity Analysis | 43 |
| 4.6.1 | Crossrail Platforms - Unmanaged Overcrowding | 43 |
| 4.6.2 | Crossrail Platforms - Managed Overcrowding | 46 |
| 4.6.3 | Crossrail Platforms - Identifying the Model Breakpoint | 47 |
| 4.6.4 | Summary - Cancelled Crossrail Train..... | 48 |
| 4.7 | Crossrail Central Concourse - Totems | 48 |
| 5 | Conclusions..... | 51 |
| 5.1 | Static Analysis..... | 51 |
| 5.2 | Dynamic Modelling | 52 |
| 6 | Further Analysis | 55 |
| 7 | Assumptions Data..... | 56 |
| | Reference Documents..... | 57 |
| | Appendix A: Revised Forecast Passenger Demand Figures..... | 58 |
| | Appendix B: Assumed Moorgate Ticket Hall Passenger Routing..... | 60 |
| | Appendix C: London Underground Audit Letter (Ref. G22-564)..... | 61 |
| | Appendix D: Dynamic Passenger Modelling Output – RIBA E..... | 62 |
| | Appendix E: Dynamic Passenger Modelling Output – Station Management | 63 |
| | Appendix F: Dynamic Passenger Modelling Output – Totems..... | 64 |

Executive Summary

The purpose of this study has been to evaluate the operational performance of the station with respect to the passenger demand forecasts stated within the Crossrail Programme Functional Requirements (CPFR), version 5.0. This study presents the findings of both static analysis and dynamic Legion modelling, which has incorporated feedback from Crossrail and London Underground following a modelling audit conducted in November 2010.

Static analysis has been undertaken to assess Liverpool Street Station in relation to the London Underground – Station Planning Standard (version 1-371-A4) and the 2026 and 2026+28%, AM and PM peak periods, passenger demand forecasts.

Subsequently, dynamic pedestrian modelling using the Legion simulation tool has been undertaken to assess Liverpool Street Station in relation to the forecast 2026 AM and PM peak period passenger demand, assuming a non-perturbed Crossrail train service (i.e. no delay or train cancellations).

In relation to the static analysis and dynamic modelling, the following areas of the station have been assessed:

- Moorgate Integrated (Crossrail and London Underground) ticket hall
- Northern Line Link (including the existing Northern Line and First Capital Connect platforms)
- Existing Moorgate ticket hall
- Crossrail platforms and access passageways
- Broadgate ticket hall (including existing Liverpool Street ticket hall B)

Sensitivity analysis has also been performed to assess the performance of the station for an alternative demand year (2026+28%, both AM and PM peak periods), totems proposed for the Crossrail central concourse, as well as a cancelled Crossrail train during the peak 15 minute period (2026 PM and 2026+28% PM peak period only).

Finally, based on the output of the cancelled Crossrail train scenario, further modelling has been undertaken to assess the extent of staff management required to reduce passenger congestion to an acceptable threshold on the eastbound Crossrail platform.

Appendix D presents full output of the Legion dynamic passenger modelling. Section 4.5 summarises the operational performance of the station with respect to the aforementioned demand years, peak periods and sensitivity tests (refer to Table 4-3 and Table 4-4).

The analysis has been assessed in relation to the standards within the Crossrail Passenger Modelling Guidelines (CR/QMS/OPS/GN/0010). Accordingly, the guidelines refer to the LU - Station Planning Standard (1-371-A4), and / or the overarching Crossrail Station Planning Standard – Platforms (CR-STD-305, version 8.0). The analysis presented within this report identifies areas where the operational performance of the station may be unacceptable, based on the forecast demand and passenger routing, and can be summarised as follows.

2026 Demand Year

With respect to the 2026 demand year and the defined acceptance criteria, the dynamic modelling of the AM and PM peak periods has shown that the operational performance of the station would be unacceptable at the following locations:

- Existing stairs connecting the Moorgate Integrated ticket hall to the Metropolitan Line eastbound platform *
- The new stairs connecting the Northern Line platforms to the Northern Line Link *
- Existing FCC platforms

* Operational performance marginally greater than acceptable threshold.

Sensitivity Analysis – 2026+28% Demand Year

Sensitivity analysis of the AM and PM peak periods has shown that in relation to the 2026+28% demand year, the operational performance of the station would be unacceptable in the following areas of the station:

- Moorgate Integrated ticket hall - westbound stairs *
- Existing stairs connecting the Integrated ticket hall to the Metropolitan Line eastbound platform
- The new stairs and cross passage linking the Northern Line platforms to the Northern Line Link
- Existing Moorgate ticket hall *
- Existing FCC platforms
- Existing Liverpool Street Ticket Hall B (paid side) *
- Passageway AP8 *

* Operational performance marginally greater than acceptable threshold.

Additional Sensitivity Analysis: 2026 and 2026+28% PM peak period demand (with a cancelled Crossrail train)

Sensitivity testing has also been undertaken to assess the operational performance of the station in the eventuality of a cancelled Crossrail train during the PM peak. In addition to the aforementioned areas that were identified as operationally unacceptable for each of the respective scenarios tested, one additional area was found to be unacceptable (refer to Table 4-5):

- Crossrail eastbound platform (both 2026 and 2026+28% with unmanaged overcrowding)

It is important to appreciate that there will be a significant period of time after 2026 when passenger demand will increase but the Crossrail train frequency will remain at 24 trains per hour, and thus the operational performance of the station will be worse than the modelling output has demonstrated for the 2026 demand year.

Further sensitivity testing has been undertaken to establish when staff management would be required, and when a proposed staff management strategy would be ineffectual in relation to the future passenger demand growth (2026+7%, 2026+14% and 2026+21%). Based on this analysis, the following general conclusions could be drawn:

- In the event of a cancelled train, management may be required from 2026 onwards
- From the 2026+7% demand scenario onwards, some passengers may be unable to embark, even before a cancelled train

- During the 2026+21% demand year, overcrowding occurs before a cancelled train, indicating that management may be required even with a non-perturbed eastbound Crossrail service
- Even with the proposed management strategy, the 2026+14% or 2026+21% models failed after a cancelled train due to overcrowding on the platforms

Finally, this report identifies a number of additional sensitivity analyses outside the scope of this study, that could be undertaken to further explore the affect of the modelling assumptions on the operational performance of the station. These include:

- Constraining the flow rate of passengers boarding and alighting trains, in line with the C160 rolling stock dwell time modelling
- Sensitivity analysis of the predicted distribution of passengers along the Crossrail platforms and more detailed modelling of the passenger waiting behaviour to explore the effect of the PEDs
- Modelling of a cancelled train on Metropolitan, Hammersmith & City, and Circle Line to determine the impact on the Moorgate ticket halls
- Assess the operational performance of the Metropolitan, Hammersmith & City, and Circle Line platforms at Liverpool Street Station

1 Background and Purpose

The purpose of this study has been to evaluate the operational performance of the station with respect to the passenger demand forecasts stated within the Crossrail Programme Functional Requirements (CPFR), version 5.0 (CR-XRL-Z-GPR-CR001-00004). This study presents the findings of both static analysis and dynamic Legion modelling, which has incorporated feedback from Crossrail and London Underground following a modelling audit conducted in November 2010.

2 Scope

Static analysis has been undertaken to assess Liverpool Street Station in relation to the London Underground – Station Planning Standard (version 1-371-A4, 2010), and the 2026 and 2026+28%, AM and PM, passenger demand forecasts (CPFR 5.0).

Subsequently, dynamic pedestrian modelling using the Legion simulation tool has been undertaken to assess Liverpool Street Station in relation to the forecast 2026 AM and PM passenger demand, assuming a non-perturbed Crossrail train service (i.e. no delay or train cancellations).

In relation to the static analysis and dynamic modelling, the following areas of the station have been assessed (refer to Figure 2-1, as well as Volume 2A and 2B for Architectural layouts of Liverpool Street Station, C138-MMD-A-DDA-C101-50001 and C138-MMD-A-DDA-C101-50002):

- Moorgate Integrated (Crossrail and London Underground) ticket hall
- Northern Line Link (including the existing Northern Line and First Capital Connect platforms)
- Existing Moorgate ticket hall
- Crossrail platforms and access passageways
- Broadgate ticket hall (including existing Liverpool Street ticket hall B)

Sensitivity analysis has also been performed to assess the performance of the station for an alternative demand year (2026+28%, both AM and PM peak periods), totems proposed for the Crossrail central concourse, as well as a cancelled Crossrail train during the peak 15 minute period (2026 PM and 2026+28% PM only).

Finally, further sensitivity testing has been undertaken to establish the extent of staff management required to reduce passenger congestion to an acceptable threshold on the eastbound Crossrail platform in the event of a cancelled train, in relation to the future passenger demand growth:

- 2026+7%
- 2026+14%
- 2026+21%

and when a proposed staff management strategy would be ineffectual (refer to Sections 4.6.2 and 4.6.3).

Figure 2-1: Plan of Liverpool Street Station identifying key areas that have been analysed by this study.

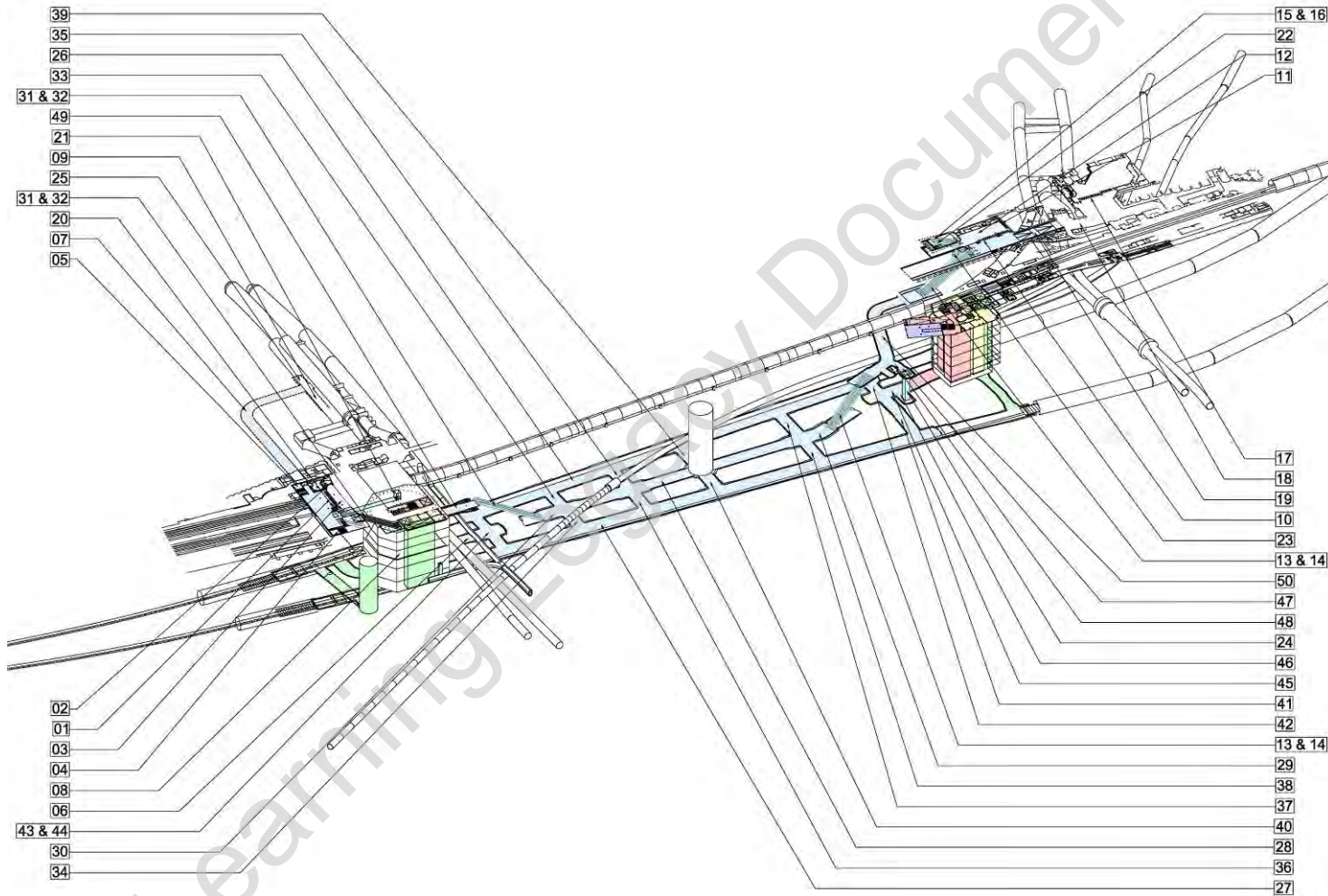

Table 2-1: Index of Liverpool Street Station areas that have been analysed by this study

| ID | Location | Description | ID | Location | Description |
|----|---|--|----|---|--|
| 1 | Moorgate Integrated ticket hall | Gateline | 26 | Crossrail | Eastbound platform |
| 2 | | POMs | 27 | | Westbound platform |
| 3 | | Concourse - Unpaid side | 28 | | Central concourse AP7 |
| 4 | | Stairs to Metropolitan Line westbound | 29 | | Central concourse at foot of Crossrail escalators to Broadgate / Liverpool street |
| 5 | | Stairs to Metropolitan Line eastbound | 30 | | Central concourse at foot of Crossrail escalators to Moorgate |
| 6 | Northern Line Link (NLL) | Passageway AP5 | 31 | | Up escalators between Crossrail platform level and Moorgate Integrated ticket hall |
| 7 | | Passageway AP6 | 32 | | Down escalators between Crossrail platform level and Moorgate Integrated ticket hall |
| 8 | | Stairs from the Crossrail platforms (AP5) to the NLL | 33 | | Cross passage CP4 (Moorgate end) |
| 9 | | Stairs linking the NLL (AP6) and existing Northern Line platforms | 34 | | Cross passage CP3 (Moorgate end) |
| 10 | Broadgate ticket hall | Gateline | 35 | | Cross passage CP4a (Moorgate end) |
| 11 | | POMs | 36 | | Cross passage CP3a (Moorgate end) |
| 12 | | Concourse - Unpaid side | 37 | | Cross passage CP8 (Broadgate end) |
| 13 | | Up escalators: Crossrail platform level to Broadgate ticket hall | 38 | | Cross passage CP7 (Broadgate end) |
| 14 | | Down escalators: Crossrail platform level to Broadgate ticket hall | 39 | | Cross passage CP6 (Broadgate end) |
| 15 | | Up escalators: Broadgate ticket hall to street level | 40 | | Cross passage CP5 (Broadgate end) |
| 16 | | Down escalators: Broadgate ticket hall to street level | 41 | Cross passage CP9 (Liv. St. PRM lift) | |
| 17 | Existing Liverpool Street ticket hall B | Gateline | 42 | Cross passage CP10 (Liv. St. PRM lift) | |
| 18 | | Passageway between Liverpool ticket hall gate-line and the Central Line escalators | 43 | Cross passage CP1 to Northern Line Link | |
| 19 | Passageway AP8 | Passageway between Broadgate ticket hall and Liverpool Street ticket hall B | 44 | Cross passage CP2 to Northern Line Link | |
| 20 | Lifts | Moorgate Integrated ticket hall to basement level via Metropolitan westbound platform | 45 | Passageway AP1 (Liv. St. PRM lift) | |
| 21 | | Moorgate Integrated ticket hall basement level to Crossrail platforms via Northern Line Link | 46 | Passageway CH7 (Liv. St. PRM lift) | |
| 22 | | Broadgate ticket hall to street level | 47 | Passageway AP11 (Liv. St. PRM lift) | |
| 23 | | Broadgate ticket hall to AP2 | 48 | Passageway AP12 (Liv. St. PRM lift) | |
| 24 | | AP2 to Crossrail platform level | 49 | Passageway AP9 | |
| 25 | | NLL (AP6) to Northern Line platforms | 50 | Passageway AP2 | |
| | | | | | Passageway between Crossrail platform level and Broadgate ticket hall |

3 Static Analysis

The following section of this report presents static analysis that has been undertaken in accordance with the London Underground – Station Planning Standard (version 1-371-A4), and the latest passenger demand forecast (CPFR version 5.0, CR-XRL-Z-GPR-CR001-00004).

As opposed to the dynamic modelling, it should be noted that the following areas of the station were outside the scope of the static analysis:

- FCC platforms
- Northern Line platforms
- Liverpool Street ticket hall B

As a consequence, in the conclusions of this study it has not been possible to compare the output of the dynamic modelling with the static analyses for these locations of the station.

3.1 Assumptions

In addition to the assumptions specified by the LU-SPS, the following assumptions were used to undertake the static analysis:

- An instruction from Crossrail has stated that the factors for converting the peak 3 hour demand to peak hour and subsequently peak 15 minute demand, should be derived from the Crossrail Demand Peaking Factors (Issue 1, February 2011, CRL1-XRL-T1-RGN-CRG02-00001). These are summarised below.

Table 3-1: Crossrail Demand Peaking Factors for Moorgate and Liverpool Street stations

| | | | | | |
|------------------|-------------|-----------|------|-----------|------|
| Moorgate | Peak period | 0700-1000 | | 1600-1900 | |
| | Peak Hour | 0815-0915 | 0.50 | 1715-1815 | 0.46 |
| | Peak 15 min | 0830-0845 | 0.27 | 1745-1800 | 0.26 |
| Liverpool Street | Peak period | 0700-1000 | | 1600-1900 | |
| | Peak Hour | 0815-0915 | 0.48 | 1715-1815 | 0.43 |
| | Peak 15 min | 0845-0900 | 0.26 | 1745-1800 | 0.26 |

- Train headways have been derived from the trains per hour (TPH) specified within the assumption coversheet spreadsheets (refer to Section 7: Assumptions Data).
- Passenger routing within Moorgate Station has been calculated from 2010 RODS data, and is presented in Appendix B.
- As opposed to the LU-SPS, 8% of Crossrail passengers during the PM peak were assumed to purchase a ticket via a Passenger Operated Machines (POMs), as stated by the CPFR 5.0 (Clause ID: CPRFR5186).

3.2 Results

Table 3-2 and Table 3-3 summarise the results of the static analysis, highlighting elements of the station where the current design does not meet the requirements of the LU-SPS (highlighted in red). The ID number within these summary tables correlates to the ID numbers referenced within station diagram (refer to Figure 2-1).

Table 3-2: Summary of LU – SPS static calculations (Part 1).

| ID | Location | Description | Minimum Design Requirement * | | | | Actual | | Units | Head height (m) |
|----|---|--|------------------------------|------|----------|------|--------|----|----------------|-----------------|
| | | | 2026 | | 2026+28% | | AM | PM | | |
| | | | AM | PM | AM | PM | | | | |
| 1 | Moorgate Integrated ticket hall | Gateline | 10 | 10 | 13 | 13 | 19 | | no. | N/A |
| 2 | | POMs | 1 | 3 | 1 | 4 | 6 | | no. | N/A |
| 3 | | Concourse - Unpaid side | 181 | 166 | 231 | 212 | 215 | | m ² | N/A |
| 4 | | Stairs to Metropolitan Line westbound ^ | 2.40 | 3.12 | 2.40 | 4.00 | 3.55 | | m | N/A |
| 5 | | Stairs to Metropolitan Line eastbound ^ | 3.60 | 2.40 | 4.61 | 2.44 | 3.23 | | m | N/A |
| 6 | Northern Line Link (NLL) | Passageway AP5 | 2.49 | 2.15 | 3.02 | 2.59 | 3.85 | | m | 2.5 |
| 7 | | Passageway AP6 | 2.49 | 2.15 | 3.02 | 2.59 | 3.03 | | m | 3.0 |
| 8 | | Stairs from the Crossrail platforms (AP5) to the NLL ^ | 2.70 | 2.40 | 3.46 | 2.84 | 3.65 | | m | N/A |
| 9 | | Stairs linking the NLL (AP6) and existing Northern Line platforms ^ | 2.70 | 2.40 | 3.46 | 2.84 | 2.40 | | m | 2.37 |
| 10 | Broadgate ticket hall | Gateline | 7 | 9 | 8 | 10 | 13 | | no. | N/A |
| 11 | | POMs | 1 | 3 | 1 | 4 | 7 | | no. | N/A |
| 12 | | Concourse - Unpaid side | 103 | 138 | 132 | 176 | 252 | | m ² | N/A |
| 13 | | Up escalators: Crossrail platform level to Broadgate ticket hall | 1 | 1 | 1 | 1 | 2 | 1 | no. | N/A |
| 14 | | Down escalators: Crossrail platform level to Broadgate ticket hall | 1 | 1 | 1 | 1 | 1 | 2 | no. | N/A |
| 15 | | Up escalators: Broadgate ticket hall to street level | 1 | 1 | 2 | 1 | 2 | 1 | no. | N/A |
| 16 | | Down escalators: Broadgate ticket hall to street level | 1 | 2 | 1 | 2 | 1 | 2 | no. | N/A |
| 17 | Existing Liverpool Street ticket hall B | Gateline | 16 | 14 | 19 | 18 | 22 ** | | no. | N/A |
| 18 | | Passageway between Liverpool ticket hall gate-line and the Central Line escalators | 5.42 | 5.18 | 6.76 | 6.47 | 8.00 | | m | 2.5 |
| 19 | Passageway AP8 | Passageway between Broadgate ticket hall and Liverpool Street ticket hall B | 4.08 | 4.88 | 5.06 | 6.07 | 6.10 | | m | 3.0 |
| 20 | Lifts (no. of pax. per lift cycle) | Moorgate Integrated ticket hall to basement level via Metropolitan westbound platform | 6 | | 8 | | 17 | | pax. | N/A |
| 21 | | Moorgate Integrated ticket hall basement level to Crossrail platforms via Northern Line Link | 9 | | 11 | | 17 | | pax. | N/A |
| 22 | | Broadgate ticket hall to street level | 5 | | 6 | | 17 | | pax. | N/A |
| 23 | | Broadgate ticket hall to AP2 | 5 | | 7 | | 17 | | pax. | N/A |
| 24 | | AP2 to Crossrail platform level | 4 | | 4 | | 17 | | pax. | N/A |
| 25 | | NLL (AP6) to Northern Line platforms | 2 | | 2 | | 13 | | pax. | N/A |

AM = AM Peak Period (07:00 - 10:00)

PM = PM Peak Period (16:00 - 19:00)

^ Dimensions between handrails

* Note that the minimum width required is 2.0m for passageways and 2.4m for two-way stairs (between handrails).

** Updated as part of Crossrail enabling works (22 gates is only after Crossrail increase the gateline capacity after enabling works)

 Compliant with LU - Station Planning Standard (1-371 A4)

 Non-compliant with LU - Station Planning Standard (1-371 A4)



Table 3-3: Summary of LU – SPS static calculations (Part 2).

| ID | Location | Description | Minimum Design Requirement * | | | | Actual | | Units | Head height (m) | |
|----|-----------|--|---|------|----------|------|--------|------|-------|-----------------|-----|
| | | | 2026 | | 2026+28% | | AM | PM | | | |
| | | | AM | PM | AM | PM | | | | | |
| 26 | Crossrail | Eastbound platform | 3.07 | 3.39 | 3.12 | 3.45 | 4.50 | | m | N/A | |
| 27 | | Westbound platform | 3.65 | 2.90 | 3.71 | 2.95 | 4.50 | | m | N/A | |
| 28 | | Central concourse AP7 | 3.18 | 2.00 | 3.90 | 2.35 | 5.47 | | m | 3.0 | |
| 29 | | Central concourse at foot of Crossrail escalators to Broadgate / Liverpool street | 3.98 | 3.96 | 4.93 | 4.91 | 7.20 | | m | 3.0 | |
| 30 | | Central concourse at foot of Crossrail escalators to Moorgate | 3.84 | 3.34 | 4.75 | 4.11 | 7.20 | | m | 3.0 | |
| 31 | | Up escalators between Crossrail platform level and Moorgate Integrated ticket hall | 1 | 1 | 2 | 1 | 2 | 1 | no. | 3.0 | |
| 32 | | Down escalators between Crossrail platform level and Moorgate Integrated ticket hall | 1 | 1 | 1 | 1 | 1 | 2 | no. | 3.0 | |
| 33 | | Cross passage CP4 (Moorgate end) | 2.00 | 2.06 | 2.00 | 2.47 | 4.65 | | m | 3.0 | |
| 34 | | Cross passage CP3 (Moorgate end) | 2.00 | 2.00 | 2.00 | 2.00 | 4.65 | | m | 3.0 | |
| 35 | | Cross passage CP4a (Moorgate end) | 2.00 | 2.00 | 2.00 | 2.00 | 4.65 | | m | 3.0 | |
| 36 | | Cross passage CP3a (Moorgate end) | 2.00 | 2.00 | 2.00 | 2.00 | 4.65 | | m | 3.0 | |
| 37 | | Cross passage CP8 (Broadgate end) | 2.00 | 2.00 | 2.00 | 2.00 | 4.65 | | m | 3.0 | |
| 38 | | Cross passage CP7 (Broadgate end) | 2.00 | 2.00 | 2.23 | 2.15 | 4.65 | | m | 3.0 | |
| 39 | | Cross passage CP6 (Broadgate end) | 2.00 | 2.00 | 2.00 | 2.00 | 4.65 | | m | 3.0 | |
| 40 | | Cross passage CP5 (Broadgate end) | 2.00 | 2.00 | 2.00 | 2.00 | 4.65 | | m | 3.0 | |
| 41 | | Cross passage CP9 (Liv. St. PRM lift) | 2.00 | 2.00 | 2.00 | 2.00 | 3.50 | | m | 2.5 | |
| 42 | | Cross passage CP10 (Liv. St. PRM lift) | 2.00 | 2.00 | 2.00 | 2.00 | 3.50 | | m | 2.5 | |
| 43 | | Cross passage CP1 to Northern Line Link | 2.00 | 2.00 | 2.00 | 2.00 | 3.90 | | m | 3.0 | |
| 44 | | Cross passage CP2 to Northern Line Link | 2.00 | 2.00 | 2.00 | 2.00 | 3.90 | | m | 3.0 | |
| 45 | | Passageway AP1 (Liv. St. PRM lift) | 2.00 | 2.00 | 2.00 | 2.00 | 4.50 | | m | 2.5 | |
| 46 | | Passageway CH7 (Liv. St. PRM lift) | 2.00 | 2.00 | 2.00 | 2.00 | 2.79 | | m | 2.5 | |
| 47 | | Passageway AP11 (Liv. St. PRM lift) | 2.00 | 2.00 | 2.00 | 2.00 | 2.50 | | m | 2.4 | |
| 48 | | Passageway AP12 (Liv. St. PRM lift) | 2.00 | 2.00 | 2.00 | 2.00 | 2.00 | | m | 2.4 | |
| 49 | | Passageway AP9 | Passageway between Crossrail platform level and Moorgate Integrated ticket hall | 3.84 | 3.34 | 4.75 | 4.11 | 5.00 | | m | 2.4 |
| 50 | | Passageway AP2 | Passageway between Crossrail platform level and Broadgate ticket hall | 3.98 | 3.96 | 4.93 | 4.91 | 4.93 | | m | 2.4 |

AM = AM Peak Period (07:00 - 10:00)

PM = PM Peak Period (16:00 - 19:00)

^ Dimensions between handrails

* Note that the minimum width required is 2.0m for passageways and 2.4m for two-way stairs (between handrails).

Compliant with LU - Station Planning Standard (1-371 A4)

Non-compliant with LU - Station Planning Standard (1-371 A4)

3.3 Summary of Static Analysis

Table 3-2 and Table 3-3 highlight that the minimum design requirements of four areas of the station exceed the provision of the current design.

- 1 The unpaid side of the new Moorgate Integrated ticket hall concourse:

| | |
|----------------------|-----------------------|
| Current design: | 215m ² |
| 2026+28% requirement | AM: 231m ² |

In order to be compliant with the LU-SPS, the required area increase is 16m². The current design area represents the absolute maximum achievable by the design team based on physical constraints. The reduced unpaid area of 16m² does not present any operational or safety concerns.

- 2 The new stairs connecting the Moorgate Integrated ticket hall to the Metropolitan Line westbound platform:

| | |
|----------------------|-----------|
| Current design: | 3.55m |
| 2026+28% requirement | PM: 4.00m |

In order to be compliant with the LU-SPS, the required increase in effective width is 0.450m. The current design width of the stairs represents the absolute maximum achievable by the design team based on the physical constraints.

- 3 The existing stairs connecting the Integrated ticket hall to the Metropolitan Line eastbound platform:

| | |
|----------------------|-----------|
| Current design: | 3.23m |
| 2026 requirement | AM: 3.60m |
| 2026+28% requirement | AM: 4.61m |

In order to be compliant with the LU-SPS, the required increase in effective width is 0.370m for 2026 and an increase of 1.380m for 2026 +28%. The eastbound stair is an existing LU asset and is going to be re-furnished with new finishes as part of the ticket hall upgrade and integration works. As an existing asset, the maximum width has been achieved and as required by CPFR v5.0 is acceptable if an appropriate station management plan is implemented – refer to section 3.4.3 for mitigation measures.

- 4 The new stairs connecting the NLL (AP6) and the Northern Line platforms:

| | |
|----------------------|-----------|
| Current design: | 2.40m |
| 2026 requirement | AM: 2.70m |
| 2026+28% requirement | AM: 3.46m |
| | PM: 2.84m |

This new stair is positioned to emerge between the two Northern Line platforms in order to provide a connection between NLL (AP6) and the Northern Line platforms. Due to the tight site constraints of the existing Northern Line tunnels / platforms, no increase in width of the staircase can be achieved. Accordingly, this area of the station is subject to a concession (C138-003E/SP0113).

3.4 Summary of Mitigations to Non – Compliances

The Crossrail CPFR v5.0, [clause 5545 – see below] - requires the station design to be compliant with all static requirements in the 2026 demand year. For the sensitivity check for 2026 + 28%, the CPFR clause states -

Crossrail station complexes shall be designed to cope with a 28% uplift in demand from the 2026 forecast (not Canary Wharf, which shall be designed to cope with a 10% uplift). This is based on a 30 TPH 200m peak Crossrail service.

As a general principle, areas which are dedicated to Crossrail (Platforms, new ticket halls and associated vertical circulation) shall - subject to affirmation - either be sized to reflect 2026 demand +28% or shall have passive provision which would enable this demand to be met without the station having to be closed (or operating with severely degraded capacity for a protracted period).

If the modelling indicates that elements of the station cannot meet this level of demand, work shall be done:

- a) To identify which elements become unacceptably overcrowded and the approximate date when this occurs.*
- b) Whether there are any reasonable station control measures which could mitigate the impact of this overcrowding which should be reflected in CRL's Resilience Plan [Ref R.21].*
- c) To identify what infrastructure based mitigation may be possible having regard for the value for money offered by such mitigation.*

CRL shall seek affirmation from Sponsor's of proposals which cannot meet 28% uplift from 2026 demand, but for which other constraints (e.g. limited ability of LU to handle growth) justify a lower capability.

As highlighted in Table 3-2 and Section 3.3, the following areas fail the static requirement:

1. The unpaid side of the new Moorgate Integrated ticket hall concourse fails the concourse area requirement.
2. The new stairs connecting the Moorgate Integrated ticket hall to the Metropolitan Line westbound platform fail in the stair width requirement.
3. The existing stairs connecting the Moorgate Integrated ticket hall to the Metropolitan Line eastbound platform fail in the stair width requirement.
4. The new stairs connecting the NLL (AP6) and the Northern Line platforms fail in the stair width requirement

The following section highlights what mitigation measures can be looked at and addresses points c) and d) of CPFR v5.0 clause 5545.

3.4.1 The unpaid side of the new Moorgate Integrated ticket hall concourse

A dynamic modelling sensitivity analysis has been undertaken on this new Moorgate Integrated ticket hall concourse – refer to 4.5.1. Results showed that the minimum available space per passenger on the unpaid side of the concourse is 2.3 m² (Walkway LOS B), which is much higher than the required minimum area of 1.0 m² per passenger.

- Active station management measures

The 16m² reduction in space on the unpaid side presents no significant operational or safety concerns. In fact the Moorgate ticket hall entrances are wide and open to the pedestrianised area on Moorfields, which in effect provides an extended unpaid concourse out into Moorfields, that will mitigate against the reduced area impact. The Moorfields pedestrianised space is an open shared level surface with the ticket hall and has always been envisaged as an extension of the unpaid ticket hall concourse.

- Infrastructure based mitigation options.

There are no practical or operational infrastructure options available to increase the unpaid side concourse area without compromising the whole Moorgate Integrated ticket hall design.

3.4.2 The new stairs connecting the Moorgate Integrated ticket hall to the Metropolitan Line westbound platform:

It is important to note that the stairs will operate as a one-way stair for the majority of the time with 97% of passenger demand using the stairs in the peak direction (refer to Table 3-4).

Table 3-4: PM 2026 passenger demand through the stairs connecting the Moorgate Integrated ticket hall to the Metropolitan Line westbound platform.

| Flow direction | 3-hour demand (pax.) | Proportion |
|--------------------|----------------------|------------|
| Met WB to Moorgate | 343 | 3% |
| Moorgate to Met WB | 10628 | 97% |

Therefore the LU-SPS one-way threshold of 35pmm would be more appropriate as opposed to the two-way threshold of 28pmm.

With the PM 2026+28% demand, the minimum width requirement for a one-way stair is 3.20m which makes the stairs compliant (refer to Table 3-7 below).

Table 3-5: Summary of LU – SPS static calculations for the new stairs connecting the Moorgate Integrated ticket hall to the Metropolitan Line westbound platform

| ID | Location | Description | Minimum Design Requirement | | Actual | Units |
|----|---------------------------------|---|----------------------------|----------|--------|-------|
| | | | PM | | | |
| | | | 2026 | 2026+28% | | |
| 4 | Moorgate Integrated ticket hall | Stairs to Metropolitan Line westbound ^ | 2.50 | 3.20 | 3.55 | m |

PM = PM Peak Period (16:00 - 19:00)

^ Dimensions between handrails

Compliant with LU - Station Planning Standard (1-371 A4)

Non-compliant with LU - Station Planning Standard (1-371 A4)

The width of the new stairs is constrained, in part, by the need to install the re-located City of London Highwalk escalator and stair access above the new stairs going to basement level.



Figure 3-1: Diagram illustrating how the WB stair is constructed below the CoL Highwalk Escalators

This layout is imposed by the space constraints of maximising the ticket hall footprint and incorporating the Highwalk escalators and stairs within the area left before encroaching into Fore Street, which is due south of the ticket hall.

Due to the rise of the Highwalk and the proximity of the WB stair below there is a height/headroom limit that governs the width of the stair. If the width of the stair is increased to comply with the static requirements the landings would have to be shorter than the width of the stair and this would create a non-compliance with the LU Standard 1-133 Stairs and Ramps.

The following active station management measures can be reviewed and developed to mitigate against any material peak period congestion or queuing issues. Alternatively, significant infrastructure based measures could be reviewed and implemented. It should be noted that some of the infrastructure options would be outside Crossrail powers to undertake, due to Limits of Deviation boundary limits.

- Active station management measures

- Enhanced levels of trained staff will be required during peak or other material times working to an agreed operational plan to actively manage the passenger flows at this location. At peak times the stair may have to be temporarily used as a single directional stair.
- Re-direct passengers to use the EB stair to ticket hall exit level via the underpass if levels of queuing and congestion become too high.
- The southern gateline could be removed to create more concourse area and permit the WB stair to be moved north and allow greater clearance under the Highwalk escalator/stair slab. However, the removal of the 5 gatelines may have an impact on the long term flexibility of the ticket hall and Moorgate station.

- Infrastructure based mitigation options

- The new stair could be made wider to comply with the static 2026 + 28% requirement if a concession was raised to the LU standard 1-133 Stairs and Ramps with regards to the landing lengths. To achieve the maximum static width requirement for the PM peak of 4.00m width, the landings would need to be reduced. There may have to be a trade off between the overall reduction of the landing before it becomes too short and causes a safety issue and the increase achievable in the overall width of the stair. To increase the stair width beyond 4m would require consultation with LU concession holders to review the landing lengths.
- If the CoL Highwalk escalator and stairs could be relocated away from the ticket hall the WB stair could be widened to the maximum requirements and as the headroom/height restriction caused by the base slab of the escalator and stairs would no longer be a constraint to the WB stair headroom clearance. The relocation of the Highwalk access would require CoL consultations and if an alternative position outside CRL limits was proposed would have to be carried out by others.

It should be noted that that as the 21 Moorfields OSD design [above the station] is not being progressed and a developer is not in place, an opportunity to review the location of the Highwalk, once a developer is on board could provide an option to relocate the Highwalk to an acceptable location for CoL, better integrated into the overall OSD master plan. This would remove the constraint on the WB stair in the ticket hall and then it could be built to comply with the width requirements.

- If the Highwalk was located in Fore Street, again the constraints on the WB stair would be removed and it could be widened. Building in Fore street would be outside Crossrail Limits of Deviation and this option would have to be negotiated by LU with the CoL separately.
- A radical infrastructure option would be to move the Crossrail escalators and PRM lift north to allow more room to move the WB stairs starting point north to allow a greater width and headroom clearance under the Highwalk. However moving the Crossrail escalators and lift would require extensive infrastructure works as this would impact on a major sewer, the Met & Circle line tracks and other major exiting LU infrastructure.

3.4.3 The existing stairs connecting the Moorgate Integrated ticket hall to the Metropolitan Line eastbound platform

It is important to note that the stairs will operate as a one-way stair for the majority of the time with 97% of passenger demand using the stairs in the peak direction (refer to Table 3-6).

Table 3-6: AM 2026 passenger demand through the stairs connecting the Moorgate Integrated ticket hall to the Metropolitan Line eastbound platform.

| Flow direction | 3-hour demand (pax.) | Proportion |
|--------------------|----------------------|------------|
| Met EB to Moorgate | 10844 | 97% |
| Moorgate to Met EB | 371 | 3% |

Therefore the LU-SPS one-way threshold of 35pmm would be more appropriate to assess the stairs as opposed to the two-way threshold of 28pmm.

With the AM 2026 demand and a one-way 35ppm capacity, the minimum width requirement is 2.88m which makes the stairs compliant for this demand. However they remain non-compliant with the AM 2026+28% demand, with a minimum required width of 3.69m (refer to Table 3-7 below).

Table 3-7: Summary of LU – SPS static calculations for the new stairs connecting the Moorgate Integrated ticket hall to the Metropolitan Line westbound platform.

| ID | Location | Description | Minimum Design Requirement | | Actual | Units |
|----|---------------------------------|---|----------------------------|----------|--------|-------|
| | | | AM | | | |
| | | | 2026 | 2026+28% | | |
| 5 | Moorgate Integrated ticket hall | Stairs to Metropolitan Line eastbound ^ | 2.88 | 3.69 | 3.23 | m |

AM = AM Peak Period (07:00 - 10:00)

^ Dimensions between handrails

Compliant with LU - Station Planning Standard (1-371 A4)

Non-compliant with LU - Station Planning Standard (1-371 A4)

A dynamic modelling sensitivity analysis has been undertaken on this new stair within the new Moorgate Integrated ticket hall – refer to section 4.5.1. To assess the magnitude of the delay experienced by passengers accessing the stairs during the AM peak 15 minutes, a journey time analysis was carried out. The Legion results showed that the average delay time, compared with a non-congested walk time, was 4.2 seconds with the 2026 demand and 11.0 seconds with the 2026+28% demand. It is important to note that passengers do not stop moving when exiting the station via the eastbound stairs: this delay is only caused by a reduction in passenger walking speed when accessing the stairs.

In reviewing this, the exit capacity of the Moorgate end of the station has been assessed (refer to Table 3-8 below).

Table 3-8: Summary of the demand and usage of the eastbound stair and Existing Moorgate ticket hall exit gates with the RODS routing assumptions for the AM 2026 and 2026+28% demand, as well as the combined exit capacity

| | | AM | |
|---|------------------|------|----------|
| | | 2026 | 2026+28% |
| Stairs to Metropolitan Line eastbound | Demand (ppm) | 101 | 129 |
| | Capacity (ppm)* | 113 | 113 |
| | Usage | 89% | 114% |
| Existing Moorgate Ticket Hall exit gates | Demand (ppm) | 132 | 142 |
| | Capacity (ppm)** | 180 | 180 |
| | Usage | 73% | 79% |
| Total | Demand (ppm) | 233 | 271 |
| | Capacity (ppm) | 293 | 293 |
| | Usage | 80% | 92% |

* Based on one-way stair capacity of 35ppm

** Based on gate capacity of 30ppm (survey data provided by LU)

While the demand through the eastbound stairs exceeds its capacity with the 2026+28% demand, it is also important to note that there is some spare exit capacity via the existing Moorgate ticket hall exit gates which is a potential route choice for passengers.

This static assessment demonstrates that the eastbound stairs could be compliant with the 2026+28% AM demand by redirecting 14% of passengers exiting the station via the eastbound stairs to exit via the existing Moorgate ticket hall.

- Active station management measures

- Re-direct passengers to use the westbound stairs to ticket hall exit level via the underpass if levels of queuing and congestion become too high
- Re-direct passengers to exit via the existing Moorgate ticket hall if levels of queuing and congestion become too high

- Infrastructure based mitigation options

- Once the existing EB stair finishes are removed during the demolition stage of the ticket hall it may provide greater space than currently thought from the surveys available. This may then allow the new cladding finishes for the stair to be moved back and increase the overall stair width. This can be determined during the construction stage by the contractor and Project Manager, and appropriate measure taken to increase the width of the stair.
- The whole existing stair could be demolished and rebuilt to the required width. It should be noted that the stair straddles the WB Met & Circle line tracks. If a wider stair was rebuilt it would compromise the area safeguarded for the future EB PRM lift. In this instance the EB PRM lift would have to be relocated or omitted.

3.4.4 The new stairs connecting the NLL (AP6) and the Northern Line platforms

The Northern Line link staircase has been a considerable challenge to design and is subject to a series of concessions due to the highly constrained area of the staircase with regards to existing LU and FCC infrastructure around the Northern Line and FCC platforms – refer to Crossrail/LU concessions, SP0110/CRO5929, SP0111/CR05930, SP0112/CRO5909, SP0113/CRO5908 and SP0109/CRO5928.

The concession specifically relating to the width of the stair is SP0113/CRO5908, which states:

This application is against LU Station Planning 1-371 clause 3.10.6.2.

“Stairway width shall be determined as follows: Two-way staircase width = (average peak minute flow/28).”

The result of this calculation is 2.70m (2026 AM peak), 2.22m (2026 PM peak), 3.46m (2026+28% AM peak) and 2.84m (2026+28% PM peak) however the maximum width that can be provided is 2.4m. Therefore the stair is not compliant for the 2026 AM peak, [which is the Crossrail minimum compliance requirement as stated in CPFR v5.0] and the sensitivity check for 2026+28% AM peak and 2026+28% PM peak.

The demand figures used are as stated in the Crossrail Project Functional Requirements (CPFR) v5.0.

The standard cannot be achieved for this new stair due to the need to tie-in to the existing LU infrastructure, which is particularly affected by the proximity of the existing LU Northern Line tunnels. This is explained in section 2.1 and plans and sections of the concession.

Numerous alternative options have been investigated by Crossrail during the last 6 years and LU to provide an alternative link that has no concessions to standards, but through this extensive and well documented work, no acceptable and buildable alternative has been identified.

The study reports have been summarised and referenced within the concession as evidence, but not included in full because of the large volume of information. For reference to this information, please refer to the list below.

These studies are detailed in the following documents that have been issued to LU:

CR-DV-LIV-CE-SR-00013 Rev 2 - Review of Options for Northern Line Link (10 Aug 2007)

Summary of the results of two workshops held with all stakeholders (including LU) to review options for the NLL. The Initial Reference Design (IRD) and six other options were reviewed (including eight other sub-options) and the resulting conclusion was to develop the IRD and two of the other options (3 and 6E) including costs and detail of LU impacts. The results of this further review are contained in CR-DV-LIV-CE-SY-00001 and summarized in CR-DV-LIV-CE-SR-00016 (see below).

CR-DV-LIV-CE-SY-00001 Rev 1 - Northern Line Link Options – IRD, 3 & 6E (10 Aug 2007)

This report reviews the findings of the further development of the three options highlighted in the initial Northern Line Link workshops as described in CR-DV-LIV-CE-SR-00013 (see above). These options are:

1. Option IRD: Construct passageway link from Crossrail Moorgate shaft to Northern Line platform by coming up between two Northern Line platforms with a new stair and PRM lift.
2. Option 3: Connect and re-configure/enlarge the two separate existing LU passageways at base of LU escalators to access Northern Line platforms.
3. Option 6E: Construct a new passageway for PRM access below the existing Moorgate LU TH infrastructure on the west to link with the west end of the NL platforms and connect/re-configure the existing LU passageways at base of LU escalators to access Northern Line platforms.

The advantages and disadvantages of each option are described, including constructability, programme, cost, static passenger modelling and impacts on LU. The report needed evaluation by Crossrail and LU to conclude the study, so that a single option could be incorporated in to the scheme design.

CR-DV-LIV-CE-SR-00016 Rev 1 - Summary of Northern Line Link Option Study (7 Sep 2007)

This report summarises the option study process (as described in the above reports) and confirms the conclusion of a final workshop held with all stakeholders (including LU) that the most feasible option in terms of constructability, usability, programme and cost is the IRD scheme. It is the IRD scheme that has formed the basis of the proposal described for this concession.

To summarise the constraints to making this new stair wider, Figure 3-2 and Figure 3-3 show how the proposed stair tunnel is positioned between and in close proximity to the NL and FCC tunnels. Figure 3-3 illustrates how the geometry of the stair (length and rise) are determined by the position of the existing FCC escalator tunnel above and the need to connect into the existing NL cross-passage. The size of the SCL tunnel, and therefore the allowable width, is determined by the need to minimize the height of the tunnel under the FCC escalator to minimize the rise of the stair and the close proximity of the adjacent Northern Line running tunnels either side of the stair at the top, see Figure 3-2.

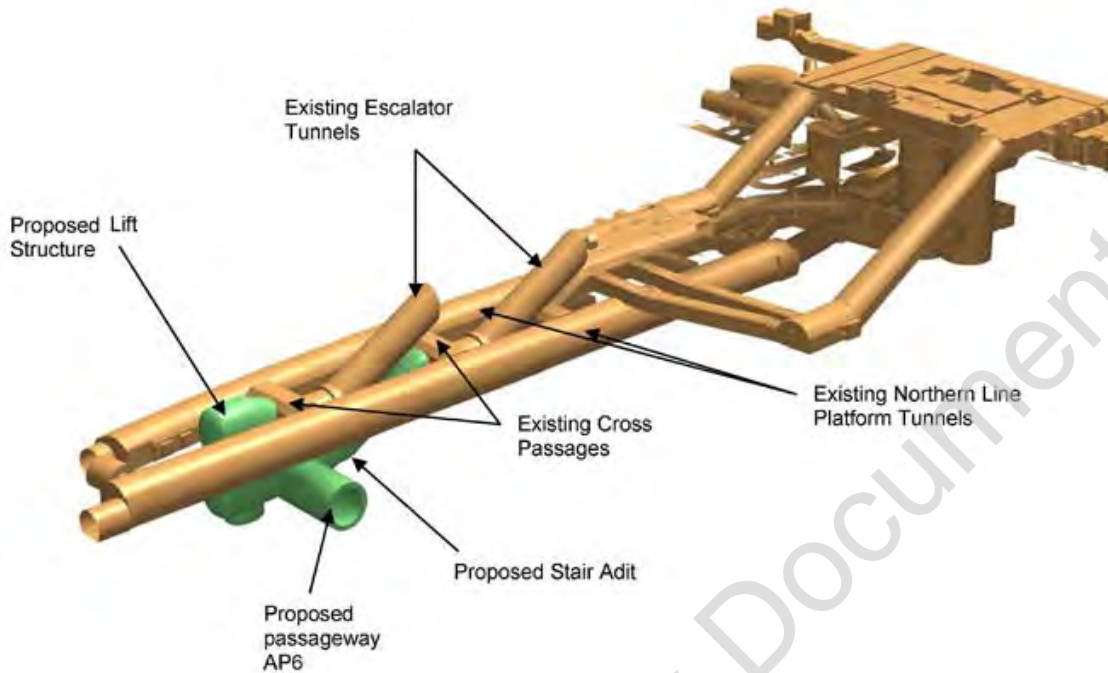

Figure 3-2: Axonometric Illustrating the Constraints of the existing Infrastructure

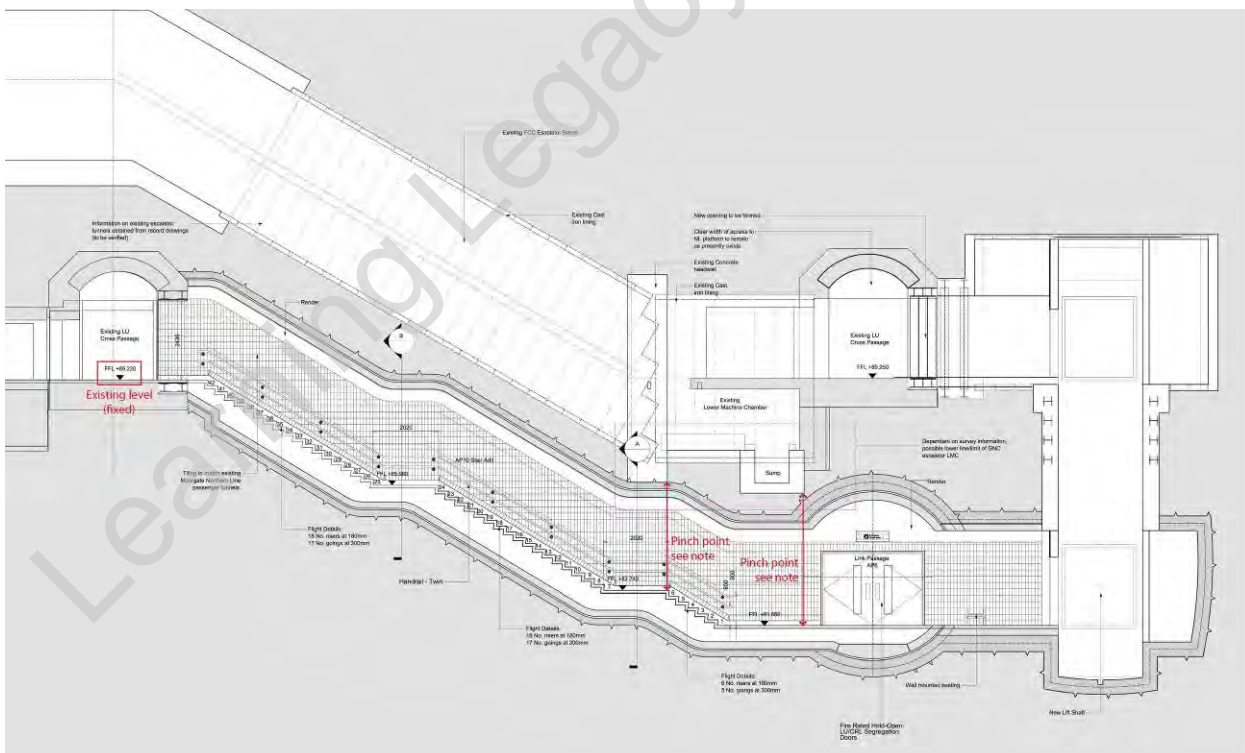

Figure 3-3: Section of Stair Illustrating the Constraints of the existing Infrastructure

Crossrail Report CR-DD-LIV-CE-SR-00002 Rev 1 “Construction Options Study” describes the difficulties of building the new tunnel in close proximity to the existing tunnels, including required protective measures for existing LU infrastructure and measures to minimize LU operational disruption. This report also incorporates the conclusions and actions from two reviews of the proposals by LU. The proposed design has been informed by this report and has maximized the size of the stair tunnel without compromising the design reviewed by LU.

Active and static mitigation measures have been proposed to address the concession issues raised by the inadequate width and a summary of these are stated below –

| Hazard | Risk | Mitigation |
|--------------------|-----------------------|---|
| Narrow stair width | Overcrowding on stair | <ul style="list-style-type: none"> • Full DDA requirements for stair nosings, handrails and tactile paving will be utilized as well as requirements for slip resistance and colour contrast. Stair nosings will match the durability of the traditional HDLT to ensure a firm tread at the edge of the step • Lighting levels will be locally increased at the landings of the stair to match the LU requirement for stepping on/off escalators (which should match or better the lighting levels at the bottom of the FCC escalator opposite) • All finishes to the stair have been minimised as far as possible to maximise the overall width available between handrails. All services are set at high level on the walls [recessed so as not to encroach onto the passenger zone] and no services are suspended from the ceiling to maximise available headroom. |
| | Overcrowding on stair | <ul style="list-style-type: none"> • This stair will have to be closely monitored at peak times and risks mitigated through management procedures in the station. The stairs are an adequate width from a safety point of view for 2 way passenger traffic. But at times of excessive congestion and overcrowding on the Northern Line link at peak times, the stairs will have to be actively managed by LU Personnel. To this end doors at the bottom of the stair have been provided to enable the link to be closed. |

Post Stage E Static Analysis and Dynamic Passenger Modelling Report Note

At the end of July 2011 LU granted the Northern Line Link stair width concession SP0113/CRO5908, as well as the other 4 concession linked to the stair with a series of conditions – please refer to the concession responses by LU John Caves. These conditions have been accepted by Crossrail/ C138 and can be or will be complied with within the design of the Northern Line Link Stair and the current Stage E design information captures these conditional requirements.

4 Dynamic Modelling

4.1 Background Information

Dynamic Legion passenger models of Liverpool Street Station were provided to the FDC by Crossrail in mid-2009. These models represented the 2016+35% passenger demand year (i.e. CPFR 4.0), and had been developed by Crossrail using the assumptions defined within the Liverpool Street Modelling Methodology report (CR-EG-LIV-X-RT-0001).

Any amendments to the modelling setup or assumptions of these models were made in consultation with Crossrail, and are outlined in the Liverpool Street Station - Revisions to the Pedestrian Modelling Assumptions report (C138-MMD-A-RGN-C101-00002).

Subsequently, a significantly revised set of modelling assumptions were issued to the FDC by Crossrail in August 2010, which accompanied the revised passenger demand forecasts (CPFR 5.0). The dynamic Legion passenger models were amended to reflect these changes, any deviation to these assumptions were made in consultation with Crossrail and were outlined in the respective Impact Assessment report (C138-MMD-A-RIA-C101-00002).

After the completion of the Impact Assessment study in October 2010, the dynamic Legion passenger models were submitted to Crossrail for auditing. London Underground (LU) undertook a detailed audit of the Legion models, and identified twelve issues (refer to LU Audit Letter,

Appendix C). These issues varied from questions that required further investigation by Crossrail, to the revision of some modelling assumptions by the FDC. Apart from three issues that required action from Crossrail (LST6, LST7 and LST8), the remaining nine issues have been addressed by the FDC (refer to the Post LU Audit Report, C138-MMD-P-RGN-C101-50001).

The dynamic modelling output within this study represents the most up-to-date design of the station and incorporates the feedback received during the audit (refer to Section 7: Assumptions Data). Before presenting the revised modelling output, the key changes made to the models as a result of the audit and their impacts are highlighted below.

4.2 Key Changes to Legion models following the LU Audit

Subsequent to the audit, the FDC has amended the Legion models based on the recommendations made by LU and Crossrail. This section summarises the three key changes, while details of all nine changes and their impacts are discussed in full within the Post LU Audit report (C138-MMD-P-RGN-C101-50001).

4.2.1 Crossrail eastbound boarding distribution assumption

The FDC was instructed to reduce the Crossrail platform length from 240m to 200m. However, the model assumptions issued by Crossrail after this instruction was issued included boarding distributions calculated for 240m long platform. Revised boarding distributions to take into account the new train stopping positions and the revised platform length of 200m have now been incorporated into the models (refer to Appendix D).

Following the introduction of a vertical lift between the Crossrail platform level and the AP2 passageway, as opposed to the inclined lift, the publicly accessible area of the platform was increased from 200m to 225m. However, it is important to note that the Crossrail train stopping position on both eastbound and westbound platforms has not changed due to this design alteration, and the Legion models accurately reflect the intended train stopping positions.

4.2.2 Alteration to lift logic and changes to PRM routing

The model setup for the lift between the Moorgate Integrated ticket hall basement level and the Crossrail platform level did not include a waiting zone on each floor level, which allowed passengers to instantaneously move from one level to another without delay. The FDC has updated the model to correct this issue, as per the LU Station Modelling with Legion - Best Practice Guide (LUL, 2009).

In relation to the routing of PRM within the Moorgate Integrated ticket hall, the model submitted for audit allowed PRM to move directly between the ticket hall and eastbound Metropolitan Line platform. The FDC has updated the Legion models to simulate the movement of PRM via the stairs leading to the eastbound Metropolitan Line platform. The impact on passenger movement via the stairs has subsequently been evaluated in relation to the standards defined within the LU-SPS (1-137-A4).

4.2.3 Moorgate ticket hall – escalators and gate-line operation

The FDC has amended the PM peak period models to reflect the existing Moorgate Ticket hall operational configuration as follows:

- 1) One up and one down escalator from / to the Northern Line platforms.
- 2) 100% of passengers interchanging from the Metropolitan Line platforms to the FCC services circulate via the down escalator to the FCC platforms, instead of the spiral stairs.

Further tests on the routing assumptions of boarders were also undertaken to determine whether the gate-line would require staff management based on the 2026 or 2026+28% demand scenarios.

4.3 Modelling Scenarios and Base Model Files

The FDC has run the following Legion model to test each scenario. In each case a completely revised set of output maps and numeric analysis for the station has been generated.

Base Models

- **2026 AM peak:**
 - LIV 2026 0800-0930 AM v02.lgm
- **2026 PM peak**
 - LIV 2026 PM_015.lgm

Sensitivity Tests

- **2026+28% AM peak**
 - LIV 2026+28_ 0800-0930 AM v04.lgm
- **2026+28% PM peak**
 - LIV 2026+28% PM_015.lgm

4.4 Assessment Criteria

The modelling has been undertaken using Legion Studio (EP 5), in accordance with the Crossrail Pedestrian Modelling Guidelines (CR/QMS/OPS/GN/0010). Section 4.5 and Appendix D present the modelling output for the peak 15-minute periods during the AM and PM, illustrating the following density level information throughout the station:

- **Cumulative Mean Density (CMD):** These maps illustrate the density experienced by each passenger, for every time step, averaged by location and presented in relation to:
 - Fruin Walkway Level of Service
 - Fruin Queuing Level of Service
- **Cumulative High Density (CHD):** These maps show the total time that density exceeds a given threshold:
 - Fruin Walkway Level of Service C (0.72 people per square metre)
 - Fruin Queuing Level of Service C (1.54 people per square metre)
 - Fruin Queuing Level of Service C (1.25 people per square metre) – platforms only.

In addition, the flow rate of passengers circulating via stairs has been assessed. The average peak minute passenger flow has been extracted from the dynamic Legion models, and has been assessed according to the LU – SPS (1-371-A4). Specifically, an acceptance threshold of 28 passengers per minute per metre width (pmm) for two-way stairs and 35pmm for one-way stairs.

Based on the passenger modelling output, the operational performance of the station has been assessed against the criteria defined within the Crossrail Pedestrian Modelling Guidelines (CR/QMS/OPS/GN/0010). Accordingly, the guidelines refer to the LU - Station Planning Standard (1-371-A4), and / or the overarching Crossrail Station Planning Standard – Platforms (CR-STD-305, version 8.0). It requires that passenger density during the peak 15 minute period satisfies the following criteria:

- Walkway Level of Service (LOS) C or better in the circulation areas.
- Queuing Level of Service (LOS) C or better in queuing areas for ticket hall facilities, and waiting / accumulation areas for platforms.
- Queuing Level of Service (LOS) B or better in open concourse areas.

The Crossrail modelling guidelines state that a platform assessment should be predominantly based on the Queuing LOS, but where the predominant platform activity is movement Walkway LOS should be used (e.g. around an adit).

4.5 Modelling Output

Appendix D presents full output and detailed analysis of the Legion dynamic passenger modelling. The following sections of this report summarise the operational performance of the station for the 2026 demand year, as well as sensitivity tests for the 2026+28% demand forecasts, and subsequently a cancelled train (2026 PM and 2026+28% PM peak periods only). Any areas where the operational performance is non-compliant are identified, and summarised in Table 4-3, Table 4-4 and Table 4-5.

As a consequence of the changes to some of the modelling assumptions and model configurations (refer to Section 4.2), the reader should be aware that the results and findings of this study are not directly comparable to any previous dynamic passenger modelling of the station.

4.5.1 Moorgate Integrated Ticket Hall

2026 Demand Year

Passenger density during the 2026 AM peak period is mainly less than or equal to the Walkway LOS C (refer to Figure 4-1). The small areas of Walkway LOS D located at the top of the two up escalators are transient, and a result of passengers stepping off the escalators. The other Walkway LOS D area at the top of the eastbound stairs is considered to be acceptable as these stairs will operate as a one-way stair for the majority of the time with 97% of passenger demand using the stairs in the peak direction. The operational performance of the Moorgate Integrated ticket hall is therefore acceptable during the 2026 AM peak period.

During the peak PM period there are significantly more passengers entering the station, but the proposed design provides sufficient capacity to cope with the demand. Density levels are less than or equal to Walkways LOS C / Queuing LOS B throughout the open areas of the concourse (refer to Figure 4-1), and are therefore acceptable (refer to Table 4-3, ID 1-3).

Figure 4-1: Cumulative Mean Density - Walkway LOS, Moorgate Integrated ticket hall (2026 demand year).

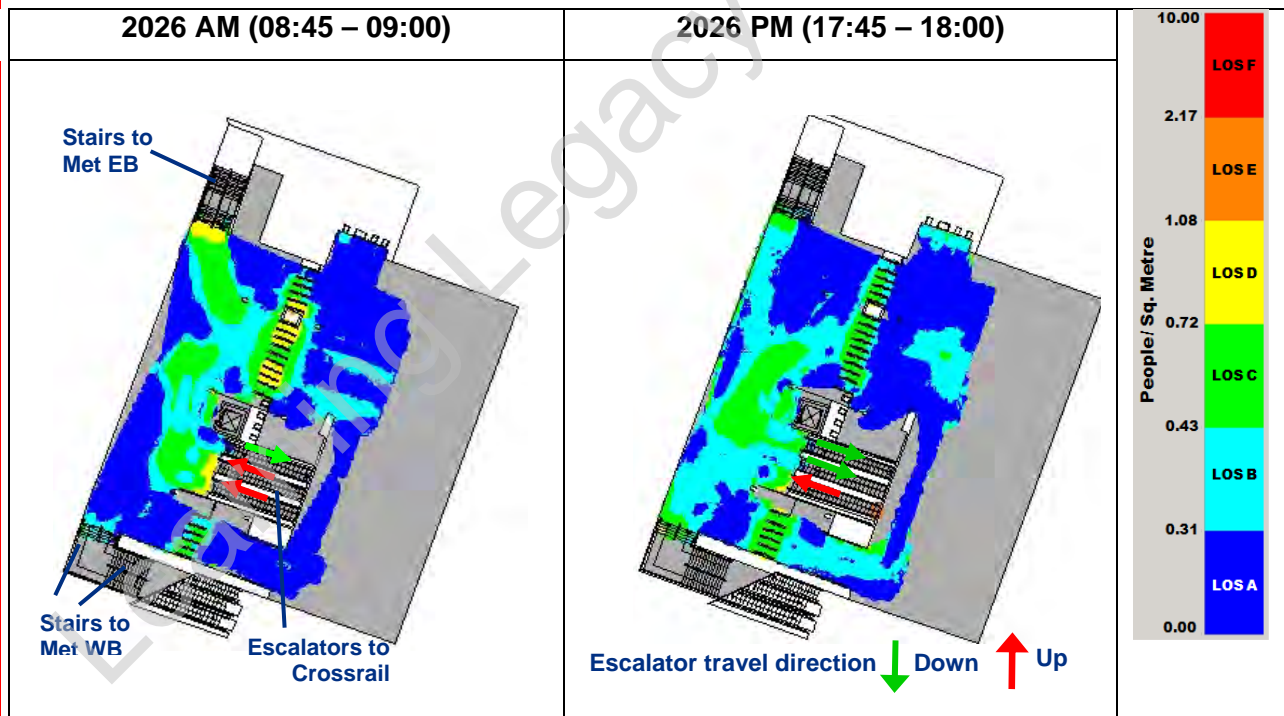

Table 4-1 highlights the AM and PM peak flow rates for the 2026 and 2026+28% demand on the stairs to the Metropolitan, Hammersmith & City and Circle Line platforms, as well as the duration that flow exceeds the LU-SPS static calculation threshold for two-way stairs (i.e. 28 passengers per minute per metre, pmm), and one-way stairs (i.e. 35pmm).

Table 4-1: Stair flow rate between the Moorgate Integrated ticket hall and the Metropolitan, Hammersmith & City and Circle Line platforms.

| | AM | | PM | | Minutes |
|--------------------------|----------|----------|----------|----------|-----------|
| | 2026 | 2026+28% | 2026 | 2026+28% | |
| Met EB Stair | | | | | |
| Maximum (pmm) | 50.5 | 54.2 | 25.7 | 31.3 | 12.5 - 15 |
| Time above 28 pmm (min) | 00:09:46 | 00:13:44 | 00:00:00 | 00:01:34 | 10 - 12.5 |
| Time above 35 pmm (min) | 00:06:46 | 00:11:57 | 00:00:00 | 00:00:00 | 7.5 - 10 |
| Averaged 1 min flow rate | 32.2 | 42.0 | 16.6 | 20.7 | 5 - 7.5 |
| | | | | | 2.5 - 5 |
| | | | | | 0 - 2.5 |

| | AM | | PM | | Minutes |
|---|----------|----------|----------|----------|-----------|
| | 2026 | 2026+28% | 2026 | 2026+28% | |
| Met WB Stair | | | | | |
| Maximum flow rate (pmm) | 21.4 | 25.6 | 36.9 | 43.7 | 12.5 - 15 |
| Time flow rate is above 28 pmm (hh:mm:ss) | 00:00:00 | 00:00:00 | 00:03:16 | 00:09:29 | 10 - 12.5 |
| Time flow rate is above 35 pmm (hh:mm:ss) | 00:00:00 | 00:00:00 | 00:00:14 | 00:03:04 | 7.5 - 10 |
| Averaged 1 min flow rate | 12.3 | 15.2 | 24.3 | 30.8 | 5 - 7.5 |
| | | | | | 2.5 - 5 |
| | | | | | 0 - 2.5 |

Table 4-1 illustrates that during the 2026 AM peak, the average flow rate on the eastbound platform stairs equates to 32pmm which is greater than the two-way stair threshold of 28pmm. However, as this stairway mainly operates as a one-way stairway, the one-way threshold of 35pmm would be more appropriate. As the flow rate exceeds the one-way threshold of 35pmm for nearly 7 of the peak 15 minutes, the eastbound stair flow rates are considered to be marginally unacceptable.

During the 2026 PM peak, the average flow rate on the westbound platform stairs equates to 24pmm which is less than the two-way stair threshold of 28pmm, but is greater than this maximum recommended flow rate for 3 of the peak 15 minutes. Based on the assessment criteria for stairs (refer to Section 4.4), the westbound stair flow rates are acceptable.

Sensitivity Analysis - 2026+28% Demand Year

During the 2026+28% AM peak period, density is mainly acceptable throughout the ticket hall (i.e. less than or equal to Walkway LOS C). The small areas of Walkway LOS D located at the top of the two up escalators are transient, and a result of passengers stepping off the escalators. Density also reaches Walkway LOS D at the top of the eastbound stair due to the large demand accessing the stair. As this stair mainly operates as a one-way stairway, the operational performance of the ticket hall during the 2026+28% AM peak is considered to be acceptable (refer to Table 4-4, ID 1-3).

The average flow rate on the eastbound platform stairs equates to 42pmm which is much greater than the one-way stair threshold of 35pmm, and exceed the one-way threshold of 35pmm for 12 of the peak 15 minutes. In addition to that, queuing occurs at the bottom of the eastbound stairs with density levels reaching Queuing LOS D. Therefore the eastbound stair flow rates are unacceptable.

During the 2026+28% PM peak period, density levels increase but remain less than or equal to Walkways LOS C / Queuing LOS B throughout the open areas of the concourse and are therefore acceptable (refer to Table 4-4, ID 1-3).

The average flow rate on the westbound platform stairs (i.e. 30.8pmm) marginally exceeds the two-way threshold during the PM peak. However, this stair mainly operates as a one-way stairway; therefore the one-way threshold of 35pmm would be more appropriate. As the flow rate exceeds the one-way threshold of 35pmm for 3 of the peak 15 minutes, the westbound stair flow rates are considered to be marginally unacceptable.

4.5.2 Northern Line Link (AP6)

2026 Demand Year

Density levels within the Northern Line Link (NLL, passageway AP6) equate to Walkway LOS C or better during both the 2026 AM and PM peak periods, except for the areas between the handrails, where density reaches LOS D (refer to Figure 4-2). However, given that movement along each side of the passageway is in effect one-way, these levels are acceptable (i.e. less than or equal to Walkway LOS D). There are no queuing or significant congestion issues along the length of the link, and therefore the operational performance of the passageway is satisfactory based on the acceptance criteria.

Moreover, it should be noted that there is an alternative design option for this NLL passageway with a larger effective width of 3.3m (based on a 2.4m head height), as opposed to the modelled width of 3.0m (based on a 3.0m head height). With this alternative design, the larger effective width for this passageway would, to some extent, reduce the observed density levels.

Figure 4-2: Cumulative Mean Density - Walkway LOS, Northern Line Link (2026 demand year).

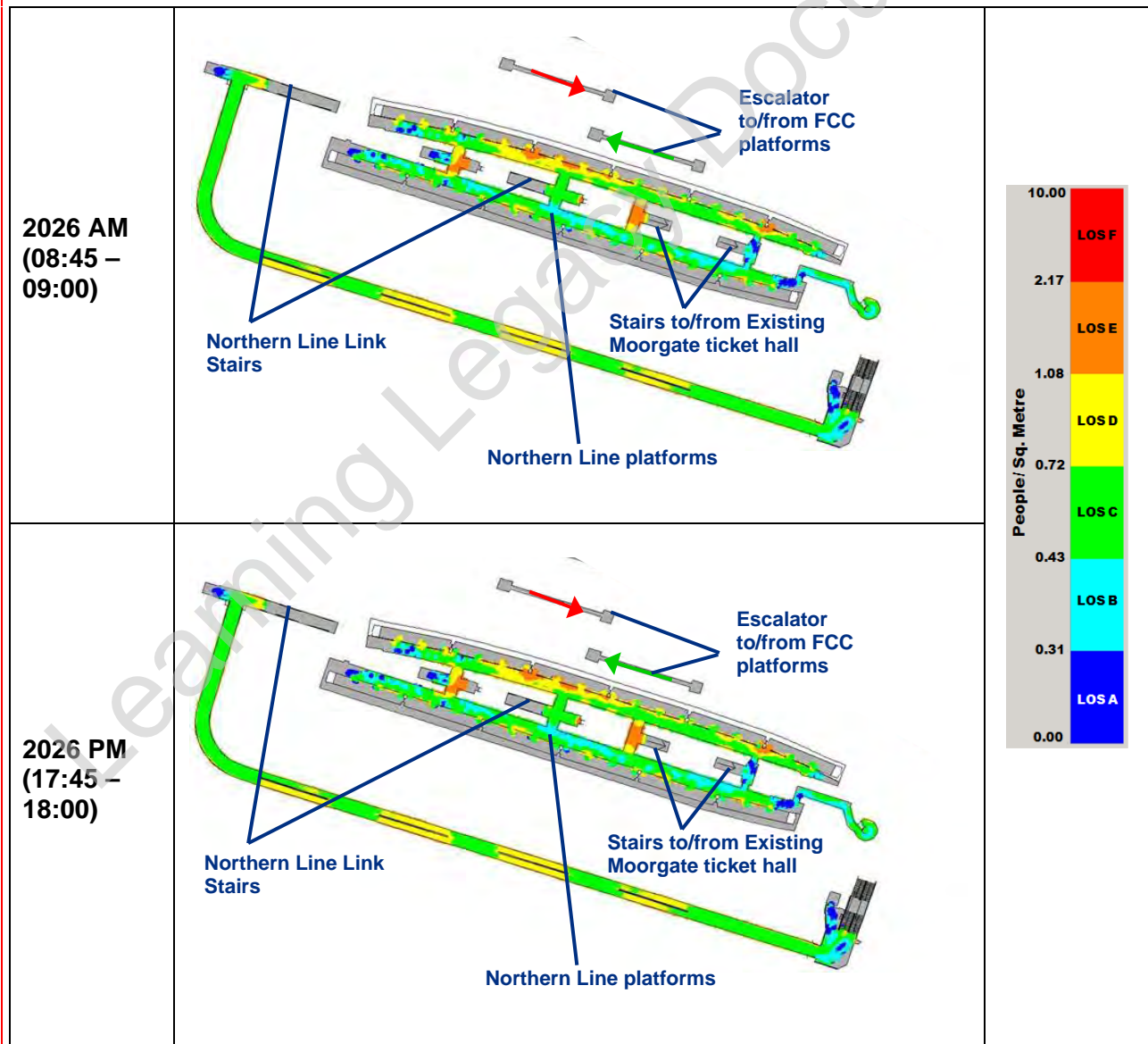

Sensitivity Analysis (2026+28% Demand Year)

Similarly, density levels within the NLL are predominately Walkway LOS C or better during 2026+28% AM and PM peak periods, except for the areas between the handrails, where density reaches LOS D. For the reasons highlighted above, the operational performance of the passageway is satisfactory based on the acceptance criteria.

4.5.3 New stairs between the NLL (AP6) and Northern Line platforms

Table 4-2 highlights the AM and PM peak period stair flow rates between the NLL and the Northern Line platforms for the 2026 and 2026+28% demand, as well as the duration that flow exceeds the LU-SPS static calculation threshold for two-way (i.e. 28pmm) and one-way stairs (i.e. 35pmm).

Table 4-2: Stair flow rates between the Northern Line Link (AP6) and the Northern Line platforms.

| NLL Stairs to NL platforms | AM | | PM | |
|---|---------|----------|---------|----------|
| | 2026 | 2026+28% | 2026 | 2026+28% |
| Maximum flow rate (pmm) | 44.2 | 56.7 | 44.2 | 55.8 |
| Time flow rate is above 28 pmm (hh:mm:ss) | 0:08:47 | 0:14:46 | 0:04:04 | 0:07:22 |
| Time flow rate is above 35 pmm (hh:mm:ss) | 0:03:35 | 0:11:17 | 0:01:23 | 0:03:38 |
| Averaged 1 min flow rate | 29.5 | 40.1 | 23.0 | 28.2 |

| | |
|---------|-----------|
| Minutes | 12.5 - 15 |
| | 10 - 12.5 |
| | 7.5 - 10 |
| | 5 - 7.5 |
| | 2.5 - 5 |
| 0 - 2.5 | |

2026 Demand Year

Table 4-2 illustrates that during the 2026 AM peak period, the average flow of passengers (29.5pmm) is marginally in excess of the two-way stair threshold of 28pmm, though the flow exceeds this threshold for nearly 9 of the peak 15 minutes. Based on the defined acceptance criteria, this average flow rate is unacceptable.

During the 2026 PM peak the average flow of passengers is acceptable (23pmm), though the maximum flow rate reaches 44ppm, and the one-way stair threshold is exceeded for over 1 minute out of the peak 15 minutes.

Sensitivity Analysis (2026+28% Demand Year)

During the 2026+28% AM peak period the average flow rate on the stairs (40pmm) is significantly higher than the two-way stair threshold of 28pmm, and approaches the upper boundary of Fruin Stair LOS D. Indeed, the two-way stair threshold is exceeded for over 14 of the peak 15 minutes, and is therefore unacceptable. This strong tidal flow necessitated the model to be configured as one-way directional movement on either side of the stairs in order to prevent the model from blocking and therefore failing to complete.

In the 2026+28% PM sensitivity test, the flow of passengers rises to just above the 28pmm threshold with an average of 28.2pmm, but exceeds the 28pmm threshold for over 7 out of the peak 15 minutes.

4.5.4 Existing Northern Line Platforms

2026 Demand Year

With respect to the existing Northern Line platforms, the modelling has shown that during the 2026 AM peak period density is predominantly Walkway LOS C (refer to Figure 4-3). However, there are some small regions of Walkway LOS D and E around the cross passages to the existing up-direction escalator, leading to the FCC platforms, and the stairs that lead to the existing Moorgate ticket hall, via the escalators. Density is greater than LOS C within these cross passages for up to 5 minutes. This slows the rate of egress from the platforms, but passenger movement does not cease at any point in time, and the congestion clears before the subsequent train arrival on the same platform. During the 2026 PM peak, density levels are predominantly equal to or less than Walkway LOS C (refer to Figure 4-3). Taken together, the operational performance of the Northern Line platforms is acceptable in the 2026 AM and PM peak periods (refer to Table 4-3, ID 6).

Density levels within the new cross passage linking the stairs to / from the NLL and the Northern Line platforms are acceptable based on forecast 2026 AM and PM demand, since they equate to Walkway LOS C or lower (refer to Table 4-3, ID 4-5).

Figure 4-3: Cumulative Mean Density - Walkway LOS, Northern Line Platforms (2026 demand year).

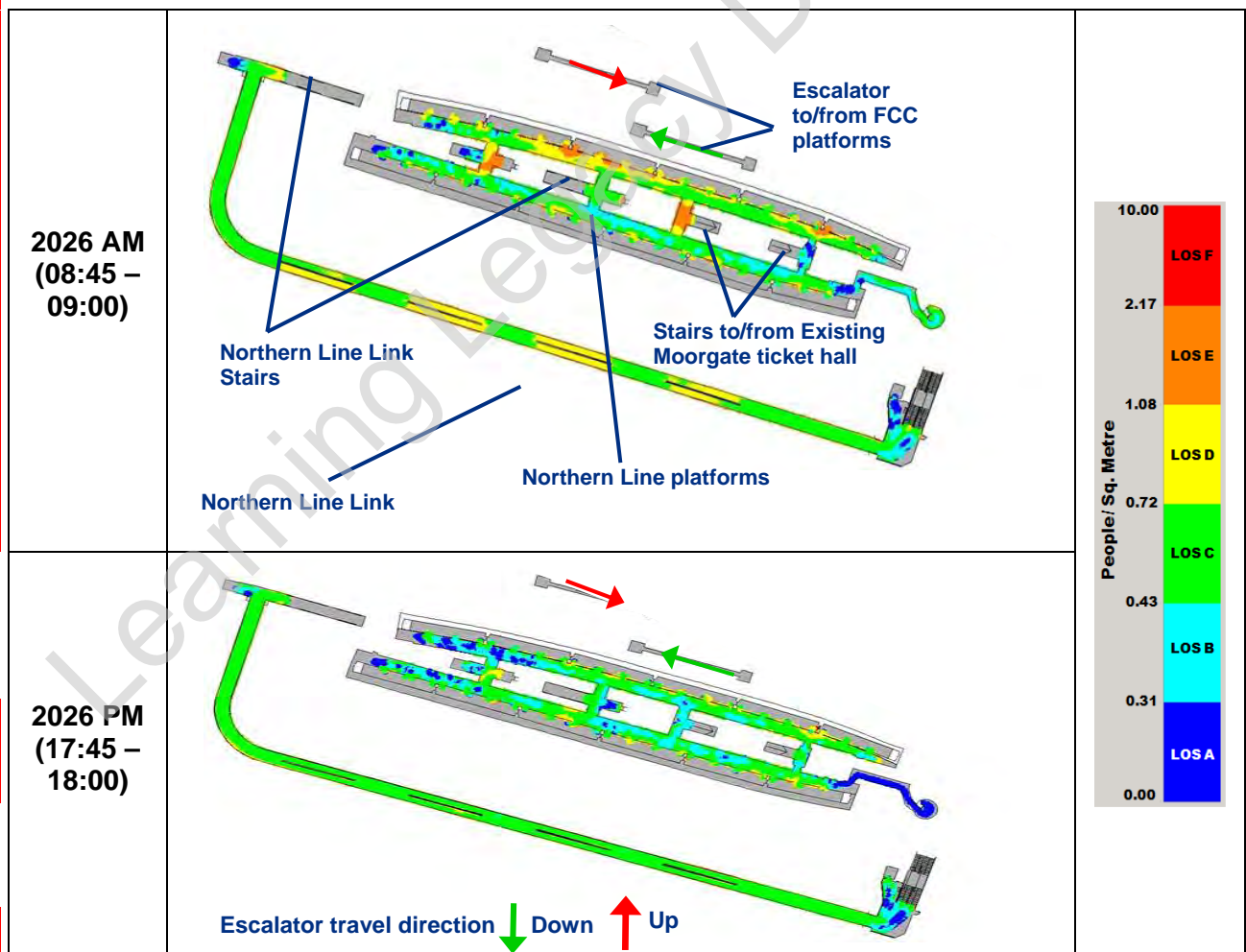

Sensitivity Analysis - 2026+28% Demand Year

In the AM 2026+28% model, density on the northbound platforms is generally acceptable, reaching a cumulative mean density no greater than Queuing LOS B. However, density does exceed the acceptable threshold for platforms (Queuing LOS C) for up to 2.5 minutes on the southbound platform. In comparison to the London Underground standards, the duration that density exceeds the acceptable threshold of 1.25 people/sq metre is also only up to 2.5 minutes. During the 2026+28% PM peak, density levels are predominantly equal to or less than Walkway LOS C. Taken together, operational performance of the Northern Line southbound and northbound platforms are acceptable based on 2026+28% demand levels.

However, it should be noted that in the event of a perturbation to the train service or unexpected peak in demand, for example, unacceptable operational conditions are likely to occur (refer to Table 4-4, ID 6).

In the 2026+28% AM sensitivity test, density levels within the new cross passage linking the stairs to / from the NLL and the Northern Line platforms are unacceptable (Walkway LOS D). Moreover, minor blockages occur at the junction between the FCC down escalator and the NLL stairs due to conflicts in bi-directional flow (refer to area circled in red, Figure 4-4). This congestion is likely to be a safety concern, particularly with respect to the flow of passengers via the down direction escalator from the FCC platforms. Density levels in the 2026+28% PM model equate to Walkway LOS C or lower, and are therefore acceptable (refer to Table 4-4, ID 4-5).

Figure 4-4: Space utilisation, Northern Line platforms (2026+28% demand year, AM peak period).

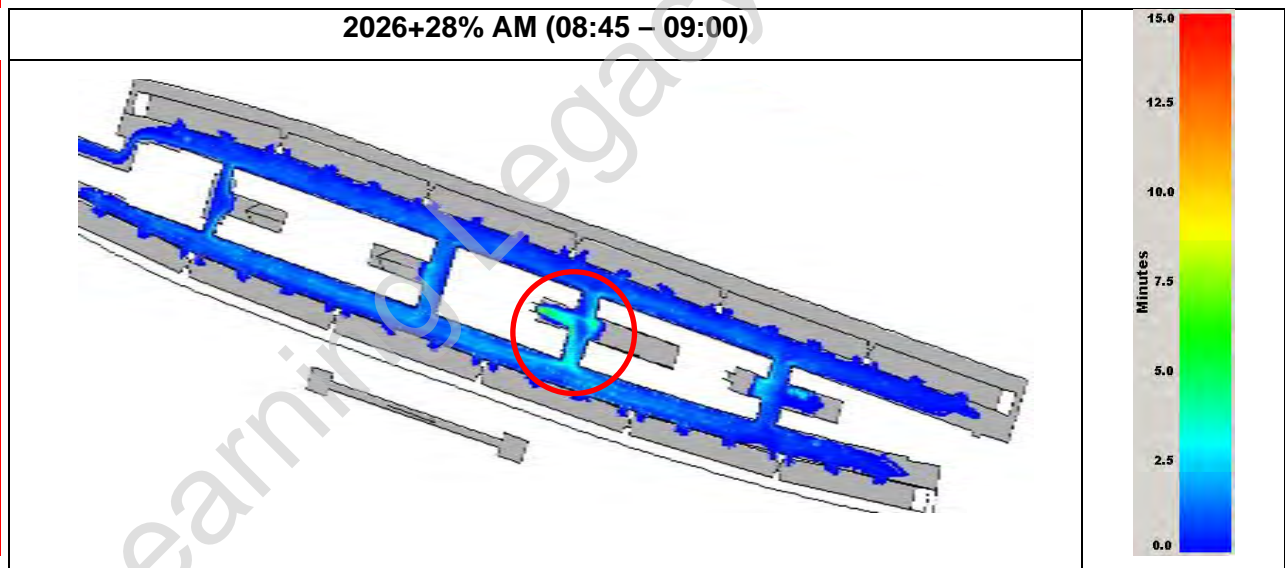

4.5.5 Existing Moorgate Ticket Hall

2026 Demand Year

With respect to the forecast 2026 AM and PM passenger demand, density levels are less than or equal to Walkway LOS C in the concourse area (refer to Figure 4-5), and do not exceed Queuing LOS C in the gateline areas. The operational performance of the ticket hall is therefore acceptable (refer to Table 4-3, ID 7).

Figure 4-5: Cumulative Mean Density - Walkway LOS, Existing Moorgate ticket hall (2026 demand year).

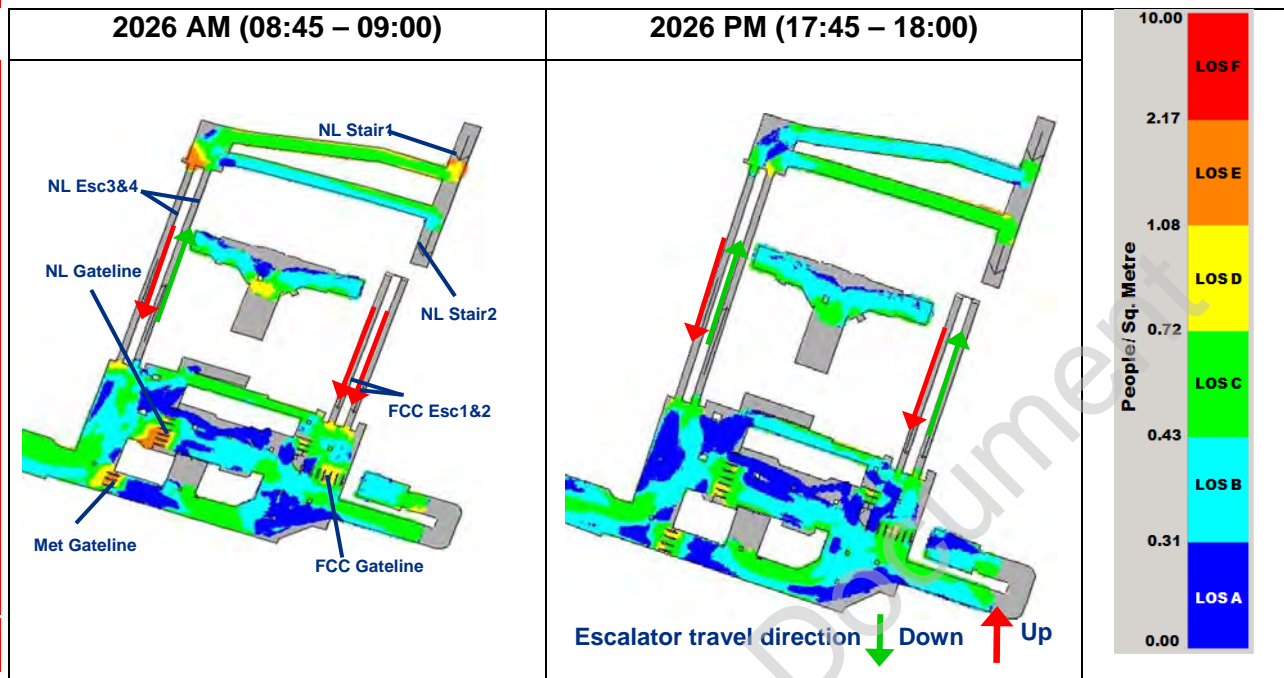

Sensitivity Analysis - 2026+28% Demand Year

In relation to the 2026+28% AM peak period, density is predominantly equal to Walkway LOS C. However, density reaches Walkway LOS D in the passageway between the ticket hall and the Metropolitan, Circle and Hammersmith & City eastbound platform. At this location density exceeds Walkway LOS C for up to 7.5 minutes (refer to Table 4-4, ID 7). Moreover, density levels reach Queuing LOS D at the NL and Met gatelines, and are above Queuing LOS C for up to 10 minutes.

It is important to note that, while the ticket hall gates were modelled with a capacity of 25 people per minute (ppm) as specified by the Legion modelling guidelines, survey data showed that the actual flow rate through the NL and Met gatelines could reach 30ppm. Additional modelling was carried out with a gate capacity of 30ppm and the results showed that the density levels at all gatelines were acceptable. Therefore the operational performance of the existing Moorgate ticket hall is marginally unacceptable.

During the 2026+28% PM peak, density levels within the existing Moorgate ticket hall are equal to, or better than, Walkway LOS C and Queuing LOS A. An exception to this observation is at the top of the down escalator to the FCC platforms, where density levels reach Walkway LOS D due to minor queuing for the down escalator (refer to Table 4-4, ID 7). However, the operational performance of the ticket hall is considered to be acceptable.

4.5.6 Existing FCC Platforms

2026 Demand Year

During the 2026 AM peak, density on the FCC platforms equates to Walkway LOS E and in several areas LOS F (refer to Figure 4-6), and is therefore unacceptable. In particular, density on the FCC Platforms is greater than Queuing LOS C for up to 5 minutes. In part, this is due to

passengers queuing to travel down to the Northern Line platforms via the escalator, which results in congestion along the platform. However, at no point do the high density levels on the FCC platforms prevent passenger movement up from the Northern Line platforms (via the escalator).

The operational performance of the FCC platforms remains unacceptable during the 2026 PM peak; with density levels reaching Walkway LOS D and E on both platforms (refer to Figure 4-6, Table 4-3, ID 8).

Figure 4-6: Cumulative Mean Density - Walkway LOS, FCC Platforms (2026 demand year).

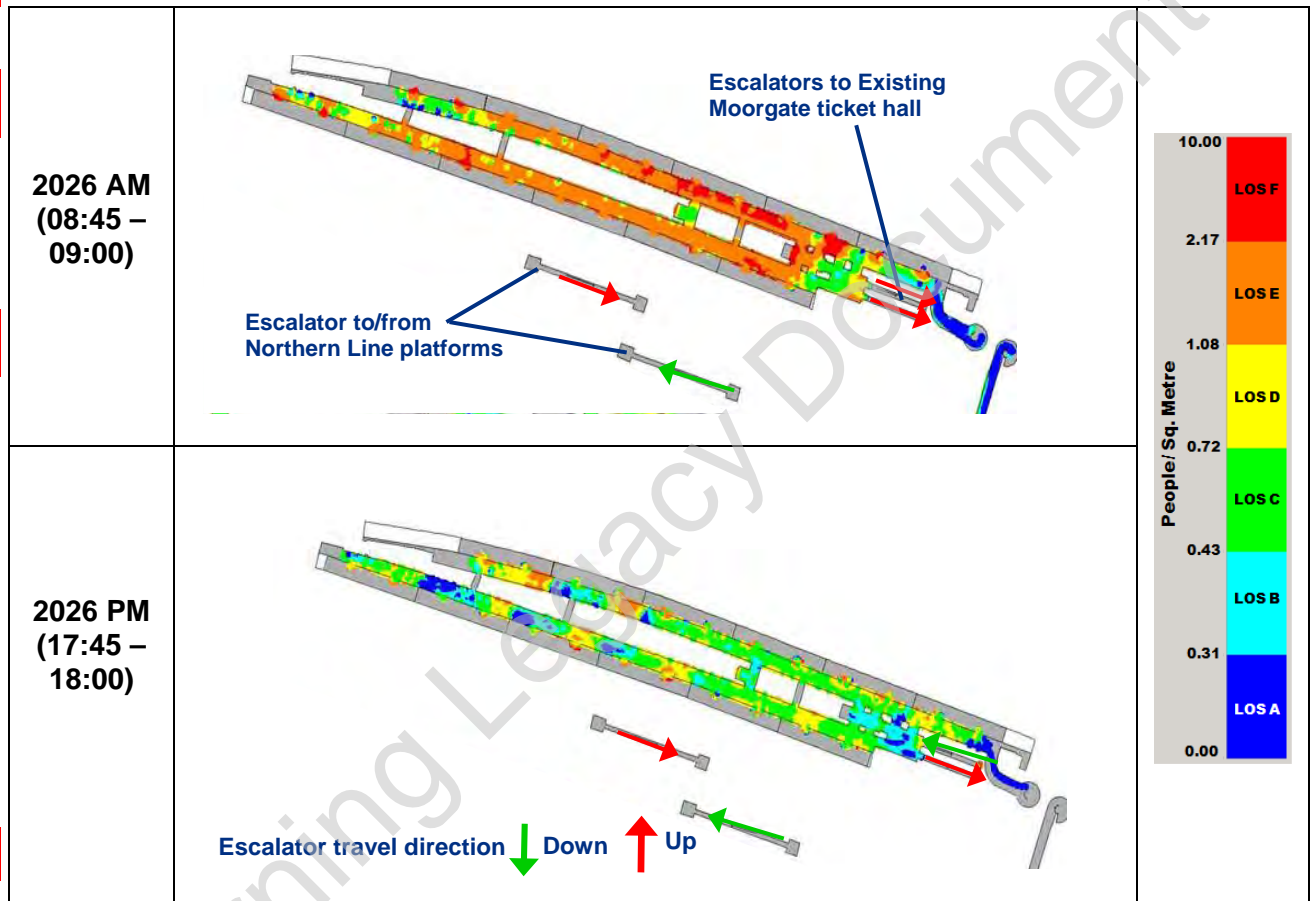

Sensitivity Analysis - 2026+28% Demand Year

With respect to the 2026+28% AM sensitivity test, density on the FCC platforms is predominantly Walkway LOS E. In comparison to the 2026 output, the level of cumulative mean density decreases due to the increase in FCC train frequency, which results in a decrease of the number of passengers alighting per individual train. However, the increase in train arrivals and total demand results in a greater occurrence of congestion which explains the increase from 5 minutes to 7.5 minutes of the duration that density exceeds Queuing LOS C. Consequently, the operational performance remains unacceptable.

In comparison to the 2026 demand year, density levels on the FCC platforms in the 2026+28% PM are lower due to the increase in FCC train frequency. However, there are some small areas of Walkway LOS D along the platforms. Therefore the operational performance is marginally unacceptable (refer to Table 4-4, ID 8).

4.5.7 Crossrail Platforms (Non-Cancelled Train)

It should be noted that the following passenger modelling output is with respect to 200m long platforms (i.e. 10 car trains), and revised platform boarding distributions provided by Crossrail / LU subsequent to the dynamic model audit. The modelling output within the proceeding section does not incorporate the proposed totems within the central concourse, though this has been analysed and is presented in Section 4.7.

Following the introduction of a vertical lift between the Crossrail platform level and the AP2 passageway, as opposed to the inclined lift, the publicly accessible area of the platform was increased from 200m to 225m. However, it is important to note that the Crossrail train stopping position on both eastbound and westbound platforms has not changed due to this design alteration, and the Legion models accurate reflect the intended train stopping positions.

Figure 4-7: Cumulative Mean Density – Walkway LOS, Crossrail platforms (2026 demand year).

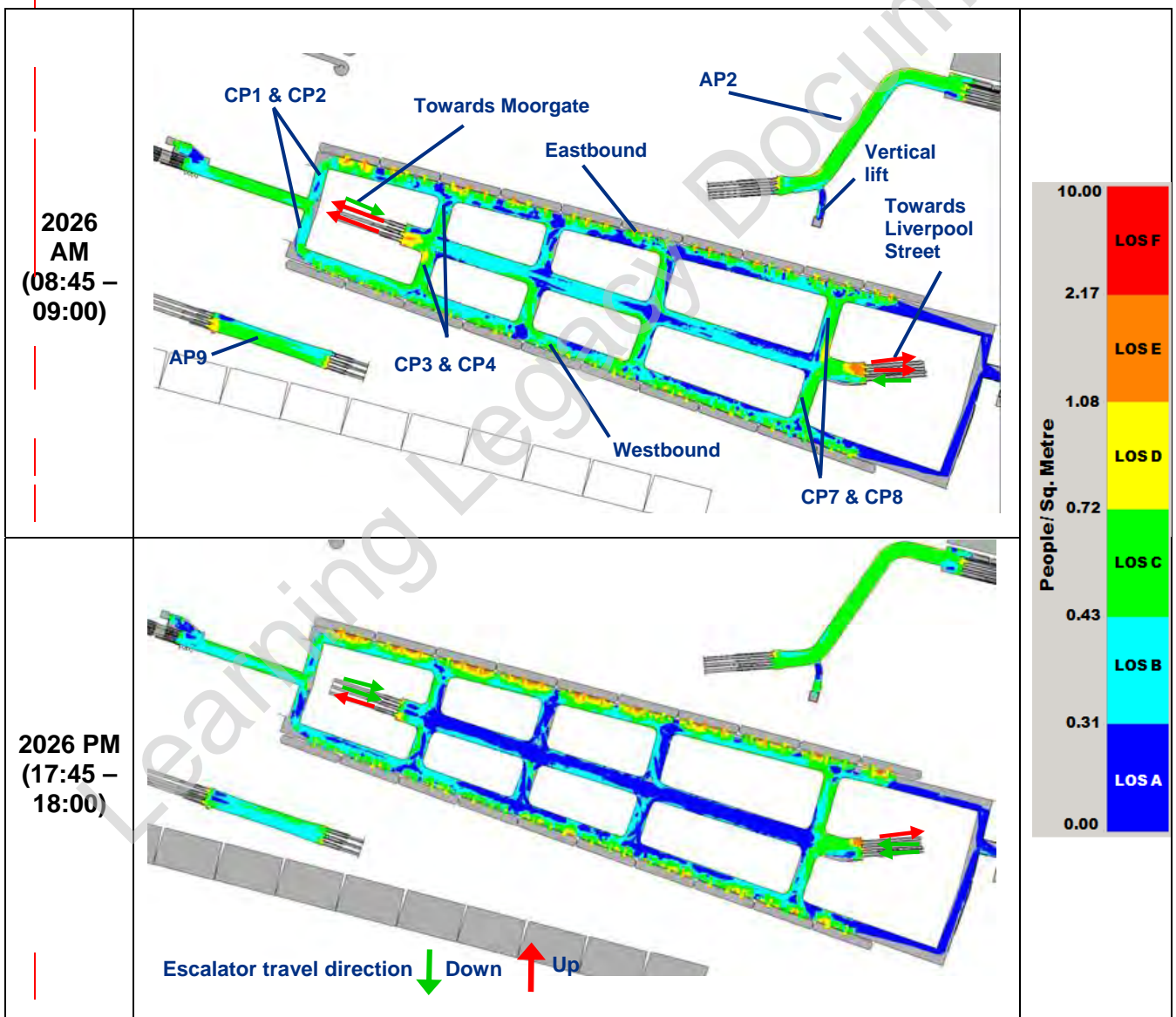
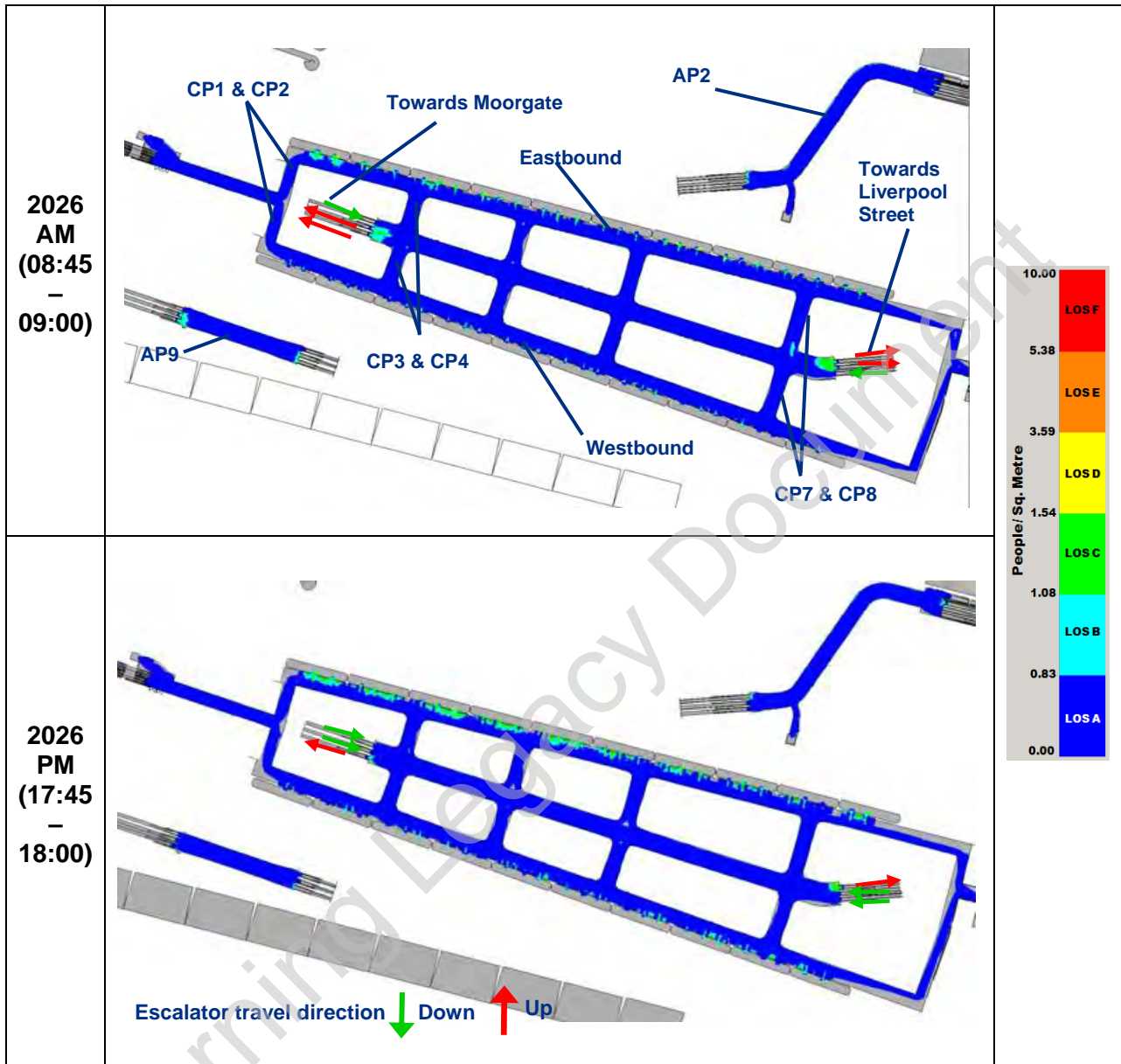

Figure 4-8: Cumulative Mean Density – Queuing LOS, Crossrail Platforms (2026 demand year).



2026 Demand Year

During the 2026 AM and PM peak periods density is acceptable throughout the westbound platform (i.e. less than or equal to Walkway LOS C, refer to Table 4-3, ID 9-10 and Figure 4-7).

With respect to the eastbound platform, during the 2026 AM peak, density is less than or equal to Walkway LOS C along the majority of the platform. Density reaches Walkway LOS D in a few localised areas adjacent to a number of platform edge doors (PEDs), which is a direct result of the simulated waiting process of boarding passengers (refer to key modelling assumptions outlined in the Revised Passenger Demand – Impact Assessment report, C138-MMD-A-RIA-C101-00002), and the caveat identified within Section 6 of this present report. Nevertheless, density along the front half of the platform (i.e. adjacent to the PEDs) is less than or equal to Queuing LOS C (refer to Figure 4-8), which is acceptable based on the Crossrail Station Planning Standard – Platforms (CR-STD-305, version 8.0).

In relation to the eastbound platform, during the 2026 PM peak, density levels are acceptable based on the assessment criteria defined by the Crossrail Station Planning Standard – Platforms (CR-STD-305, version 8.0). From 17:30 to 18:15, cumulative mean density is less than or equal to Walkway LOS C within the circulatory area at the back of the platform. Density levels within the waiting / accumulation area at the front of the platform (i.e. adjacent to the PEDs) are acceptable, since they are predominantly less than or equal to Queuing LOS C (refer to Table 4-3, ID 9-10, Figure 4-7 and Figure 4-8).

Sensitivity Analysis - 2026+28% Demand Year

With respect to the 2026+28% sensitivity test, during both the AM and PM peak periods, density is acceptable on the westbound platform (i.e. less than or equal to Walkway LOS C).

In relation to the eastbound platform, density during the 2026+28% AM is less than or equal to Walkway LOS C along most of the platform. Density reaches Walkway LOS D in small areas adjacent to the platform edge doors, but is less than or equal to Queuing LOS C, and is therefore acceptable based on the Crossrail Station Planning Standard for platforms. Figure 4-9 illustrates the extent of congestion on the eastbound platform during the busiest period of activity in the 2026 and 2026+28% PM peak. In comparison to the 2026 demand year, density levels increase in relation to the 2026+28% PM peak, reaching Walkway LOS E adjacent to platform edge doors. Nevertheless, cumulative mean density is less than or equal to Walkway LOS C within the circulatory area at the back of the platform, and density levels within the waiting / accumulation area at the front of the platform (i.e. adjacent to the PEDs) are predominantly less than or equal to Queuing LOS C. Therefore the operational performance of the eastbound platform is acceptable (refer to Table 4-4, ID 9-10).

However, it should be acknowledged that the simulated density levels are dependent on the accuracy of the predicted boarding passenger platform distributions provided by Crossrail (refer to key modelling assumptions outlined in the Revised Passenger Demand – Impact Assessment report, C138-MMD-A-RIA-C101-00002), and the caveat identified within Section 6 of this present report). A significant variation to these profiles or a perturbation to the Crossrail services may significantly affect the operational performance of the Crossrail platforms (refer to Section 4.6: Cancelled Crossrail Train Sensitivity Analysis).

Figure 4-9: Extent of congestion during the busiest period of activity at the Moorgate end of the eastbound platform (without cancelled train scenario).

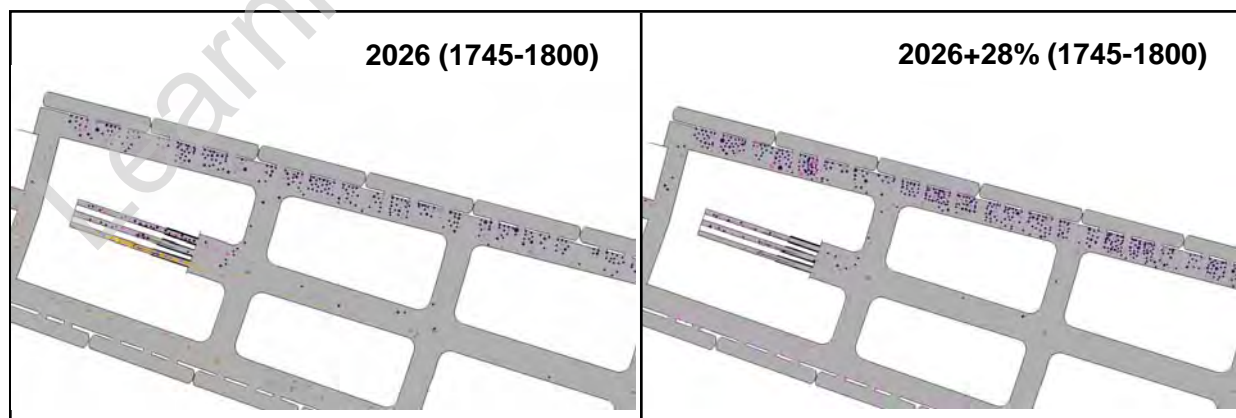

4.5.8 Crossrail Platform Adits and Central Concourse (Non-Cancelled Train)

2026 Demand Year

During the 2026 AM and PM peak, density reaches a maximum of Walkway LOS C within the central concourse and all platform adits (refer to Figure 4-7). An exception is the density within adits CP3 and CP8 where there are very small areas of Walkway LOS D. However, density within these adits only exceeds LOS C for up to 2.5 minutes of the peak 15 minutes.

In relation to both the central concourse and platform adits, it should be noted that the modelled width of these passageways correlates to a head height of 3.0m, and thus the effective width of a lower head height would be wider. For example, a 2.4m head height equates to an effective width of 5.26m for CP3 and CP8, as opposed to the 4.65m simulated within the model. Based on a head height of 2.4m, for instance, the larger effective width of these passageways is likely to reduce the density levels in the busier adits. Taken together, the operational performance of these areas of the station are acceptable (refer to Table 4-3, ID 11-21).

Sensitivity Analysis - 2026+28% Demand Year

In relation to both the 2026+28% AM and PM peaks, cumulative mean density is predominately less than or equal to Walkway LOS C within the central concourse and all cross passages. Density reaches Walkway LOS D within very small sections of cross passages CP3, CP4, CP7 and CP8, but does not exceed LOS C for more than 2.5 minutes of any peak 15 minute period.

To reiterate, there is an alternative design option for these passageways with a larger effective width based on a 2.4m head height, as opposed to the modelled width based on a 3.0m head height. With this alternative design, the larger effective width of these passageways is likely to resolve these small regions of unacceptable density. In this context, the operational performance of these areas of the station are acceptable (refer to Table 4-4, ID 11-21).

4.5.9 Passageways AP2 and AP9

2026 Demand Year and Sensitivity Analysis (2026+28% Demand Year)

During both the 2026 and 2026+28% sensitivity analysis, AM and PM peaks, density levels within AP2 and AP9 are acceptable at less than or equal to Walkway LOS C (refer to Table 4-3 and Figure 4-7, as well as Table 4-4, ID 22 and 23).

4.5.10 Broadgate Ticket Hall, Access Passageway AP8, and the existing Liverpool St Ticket Hall B

2026 Demand Year

During both the AM and PM 2026 peak periods, density levels remain within acceptable parameters throughout the Liverpool Street end of the station, with density levels less than or equal to Walkway LOS C in the Broadgate ticket hall, AP8 and Liverpool Street ticket hall B (refer to Table 4-3, ID 24-28, and

Figure 4-10).

Figure 4-10: Cumulative Mean Density - Walkway LOS, Broadgate ticket hall, passageway AP8, and existing Liverpool Street ticket hall B (2026 demand year).

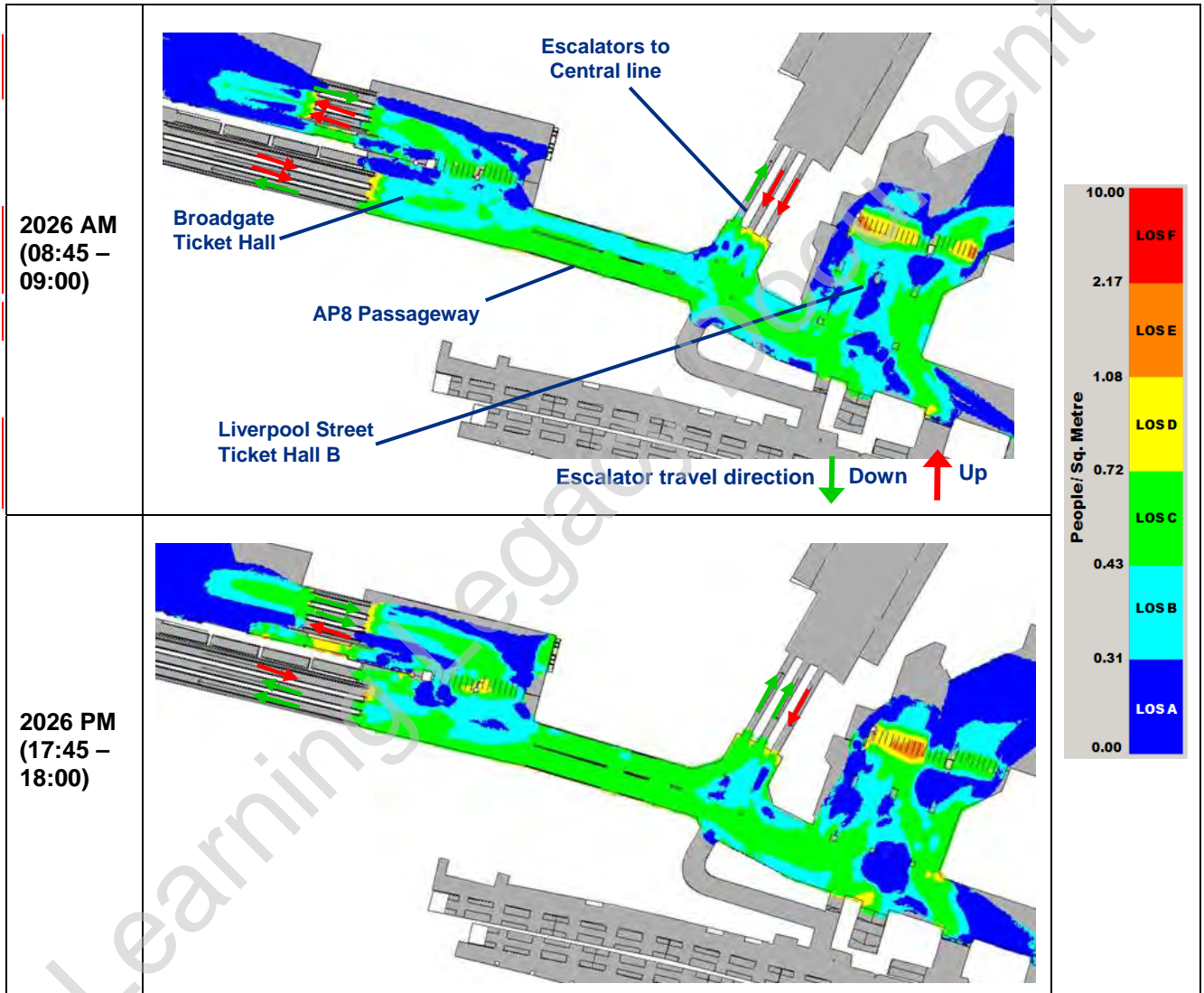

Sensitivity Analysis - 2026+28% Demand Year

In relation to the 2026+28% sensitivity tests, during both the AM and PM peak periods, density is mainly acceptable within the Liverpool Street end of the station (i.e. density levels are generally less than or equal to Walkway LOS C). However, there are a few locations where density is greater than the acceptable threshold. For example, cumulative mean density reaches Walkway LOS D at the entrance of the adits linking the paid side of ticket hall B to the Metropolitan, Hammersmith & City and Circle Line platforms, as well as an isolated region of AP8. Density exceeds LOS C for up to 7.5 minutes in ticket hall B and up to 5 minutes in AP8.

On this basis, in terms of operational performance these areas of the station are marginally unacceptable (refer to Table 4-4, ID 24-28).

It should be noted that the Metropolitan, Hammersmith & City and Circle Line platforms themselves were outside the scope of this study, and these areas have therefore not been assessed in terms of their operational performance.

Revision to the design

The models and simulation output presented within this study include five POMs within the proposed Broadgate ticket hall. In consultation and agreement with LU, this provision is being modified by Crossrail through change control, and now seven POMs will be provided. Without an increase in the proportion of passengers purchasing tickets, this change would only have a positive impact on the ticket hall, since the simulated length of passenger queuing and waiting could only decrease, and the identified location of the additional POMs will not adversely affect the circulation of the remaining passengers.

Table 4-3: Summary of the Legion modelling output for the 2026 demand year, without a cancelled train.

| ID | Location | Description | No Cancelled Train | | | | | |
|----|---|---|--------------------|-------------|-------------|--------------|-------------|-------------|
| | | | AM Peak 2026 | | | PM Peak 2026 | | |
| | | | 08:30-08:45 | 08:45-09:00 | 09:00-09:15 | 17:30-17:45 | 17:45-18:00 | 18:00-18:15 |
| 1 | Moorgate Integrated ticket hall | Paid side | | Pass | | | Pass | |
| 2 | | Stairs to Metropolitan Line westbound ** | | Pass | | | Pass | |
| 3 | | Stairs to Metropolitan Line eastbound ** | | Fail* | | | Pass | |
| 4 | Northern Line Link | Passageways AP5 and AP6 | | Pass | | | Pass | |
| 5 | | Stairs and adit linking the NLL (AP6) and existing Northern Line platforms ** | | Fail* | | | Pass | |
| 6 | Existing Northern Line | Platforms | | Pass | | | Pass | |
| 7 | Existing Northern Moorgate ticket hall | Paid side | | Pass | | | Pass | |
| 8 | Existing FCC | Platforms | | Fail | | | Fail | |
| 9 | Crossrail | Eastbound platform | Pass | Pass | Pass | Pass | Pass | Pass |
| 10 | | Westbound platform | Pass | Pass | Pass | Pass | Pass | Pass |
| 11 | | Central concourse | Pass | Pass | Pass | Pass | Pass | Pass |
| 12 | | Cross passage CP4 (Moorgate end) | Pass | Pass | Pass | Pass | Pass | Pass |
| 13 | | Cross passage CP3 (Moorgate end) | Pass | Pass | Pass | Pass | Pass | Pass |
| 14 | | Cross passage CP4a (Moorgate end) | Pass | Pass | Pass | Pass | Pass | Pass |
| 15 | | Cross passage CP3a (Moorgate end) | Pass | Pass | Pass | Pass | Pass | Pass |
| 16 | | Cross passage CP8 (Broadgate end) | Pass | Pass | Pass | Pass | Pass | Pass |
| 17 | | Cross passage CP7 (Broadgate end) | Pass | Pass | Pass | Pass | Pass | Pass |
| 18 | | Cross passage CP6 (Broadgate end) | Pass | Pass | Pass | Pass | Pass | Pass |
| 19 | | Cross passage CP5 (Broadgate end) | Pass | Pass | Pass | Pass | Pass | Pass |
| 20 | | Cross passage CP1 (Northern Line Link) | Pass | Pass | Pass | Pass | Pass | Pass |
| 21 | Cross passage CP2 (Northern Line Link) | Pass | Pass | Pass | Pass | Pass | Pass | |
| 22 | Passageway AP9 | Passageway between Crossrail platforms and Moorgate combined ticket hall | Pass | Pass | Pass | Pass | Pass | Pass |
| 23 | Passageway AP2 | Passageway between Crossrail platforms and Broadgate ticket hall | Pass | Pass | Pass | Pass | Pass | Pass |
| 24 | Broadgate ticket hall | Unpaid side | | Pass | | | Pass | |
| 25 | | Paid side | | Pass | | | Pass | |
| 26 | Existing Liverpool Street ticket hall B | Paid side | | Pass | | | Pass | |
| 27 | | Head of escalators leading to the Central line platforms | | Pass | | | Pass | |
| 28 | Passageway AP8 | Passageway between Broadgate ticket hall and Liverpool Street ticket hall B | | Pass | | | Pass | |

- Key**
- (Green) - Pass. Congestion and/or flow rates are acceptable
 - (Red) - Failure due to high levels of congestion or flow rates which are significantly above the acceptance criteria
 - *(Red) - Failure due to levels of congestion or flow rates being marginally above the acceptance criteria
 - **(Blue) Based on appraisal of average peak minute flow data extracted from dynamic Legion modelling outputs



Table 4-4: Summary of the Legion modelling output for the 2026+28% sensitivity tests, without a cancelled train.

| ID | Location | Description | No Cancelled Train | | | | | |
|----|---|---|--------------------|-------------|-------------|------------------|-------------|-------------|
| | | | AM Peak 2026+28% | | | PM Peak 2026+28% | | |
| | | | 08:30-08:45 | 08:45-09:00 | 09:00-09:15 | 17:30-17:45 | 17:45-18:00 | 18:00-18:15 |
| 1 | Moorgate Integrated ticket hall | Paid side | | Pass | | | Pass | |
| 2 | | Stairs to Metropolitan Line westbound ** | | Pass | | | Fail* | |
| 3 | | Stairs to Metropolitan Line eastbound ** | | Fail | | | Pass | |
| 4 | Northern Line Link | Passageways AP5 and AP6 | | Pass | | | Pass | |
| 5 | | Stairs and adit linking the NLL (AP6) and existing Northern Line platforms ** | | Fail | | | Fail* | |
| 6 | Existing Northern Line | Platforms | | Pass | | | Pass | |
| 7 | Existing Northern Moorgate ticket hall | Paid side | | Fail* | | | Pass | |
| 8 | Existing FCC | Platforms | | Fail | | | Fail* | |
| 9 | Crossrail | Eastbound platform | Pass | Pass | Pass | Pass | Pass | Pass |
| 10 | | Westbound platform | Pass | Pass | Pass | Pass | Pass | Pass |
| 11 | | Central concourse | Pass | Pass | Pass | Pass | Pass | Pass |
| 12 | | Cross passage CP4 (Moorgate end) | Pass | Pass | Pass | Pass | Pass | Pass |
| 13 | | Cross passage CP3 (Moorgate end) | Pass | Pass | Pass | Pass | Pass | Pass |
| 14 | | Cross passage CP4a (Moorgate end) | Pass | Pass | Pass | Pass | Pass | Pass |
| 15 | | Cross passage CP3a (Moorgate end) | Pass | Pass | Pass | Pass | Pass | Pass |
| 16 | | Cross passage CP8 (Broadgate end) | Pass | Pass | Pass | Pass | Pass | Pass |
| 17 | | Cross passage CP7 (Broadgate end) | Pass | Pass | Pass | Pass | Pass | Pass |
| 18 | | Cross passage CP6 (Broadgate end) | Pass | Pass | Pass | Pass | Pass | Pass |
| 19 | | Cross passage CP5 (Broadgate end) | Pass | Pass | Pass | Pass | Pass | Pass |
| 20 | Cross passage CP1 (Northern Line Link) | Pass | Pass | Pass | Pass | Pass | Pass | |
| 21 | Cross passage CP2 (Northern Line Link) | Pass | Pass | Pass | Pass | Pass | Pass | |
| 22 | Passageway AP9 | Passageway between Crossrail platforms and Moorgate combined ticket hall | Pass | Pass | Pass | Pass | Pass | Pass |
| 23 | Passageway AP2 | Passageway between Crossrail platforms and Broadgate ticket hall | Pass | Pass | Pass | Pass | Pass | Pass |
| 24 | Broadgate ticket hall | Unpaid side | | Pass | | | Pass | |
| 25 | | Paid side | | Pass | | | Pass | |
| 26 | Existing Liverpool Street ticket hall B | Paid side | | Fail* | | | Fail* | |
| 27 | | Head of escalators leading to the Central line platforms | | Pass | | | Pass | |
| 28 | Passageway AP8 | Passageway between Broadgate ticket hall and Liverpool Street ticket hall B | | Fail* | | | Fail* | |

Key (Green) - Pass. Congestion and/or flow rates are acceptable
 (Red) - Failure due to high levels of congestion or flow rates which are significantly above the acceptance criteria
 * (Red) - Failure due to levels of congestion or flow rates being marginally above the acceptance criteria
 ** (Blue) Based on appraisal of average peak minute flow data extracted from dynamic Legion modelling outputs

4.6 Cancelled Crossrail Train – Additional Sensitivity Analysis

Subsequent to the analysis conducted for a non-perturbed train service, additional sensitivity analysis has been conducted to assess a scenario whereby a Crossrail train is cancelled on the busiest platform (i.e. eastbound), during the PM peak period. The FDC has run the following Legion model to test each scenario:

- Cancelled train - 2026 PM peak
 - LIV 2026 PM_016.lgm
- Cancelled train – 2026+28% PM peak
 - LIV 2026+28% PM_016.lgm

4.6.1 Crossrail Platforms - Unmanaged Overcrowding

2026 and 2026+28% Demand Years (Cancelled Train Scenario)

With respect to the 2026 and 2026+28% PM cancelled train sensitivity tests, density is acceptable throughout the westbound platform (i.e. less than or equal to Walkway LOS C).

However, during both the 2026 and 2026+28% PM peak periods, the density levels are unacceptable on the eastbound platform. Large portions of the platform experience cumulative mean density greater than Walkway LOS C, for a sustained duration, across the entire width of the platform (refer Figure 4-11 and Appendix D). Indeed, in many regions of the platform density reaches Walkway LOS E, and even LOS F. Although density is more acceptable in the circulation area toward the back of the platform, density levels along the platform edge doors exceeds the acceptable threshold (i.e. greater than Queuing LOS C), for up to 12 minutes during the peak 15 minutes in some locations (refer to Table 4-5, ID 9-10).

Figure 4-11: Legion modelling output for the Crossrail platforms (cancelled Crossrail train scenario), during the PM peak period (2026 and 2026+28% demand years).

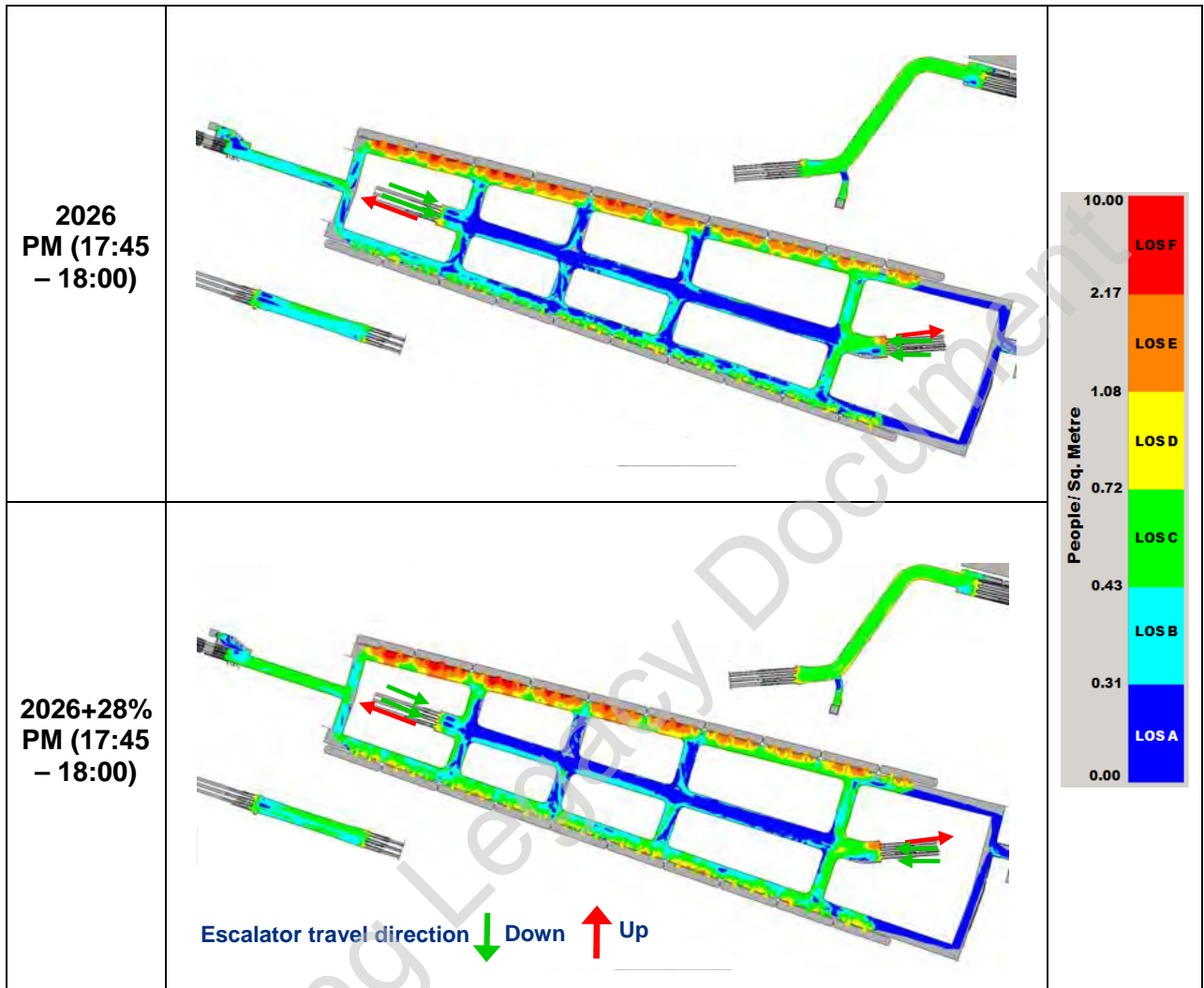

Table 4-5: Summary of the Legion modelling output for the 2026 and 2026+28% demand years (cancelled Crossrail train scenario).

| ID | Location | Description | Cancelled Train | | | | | |
|----|--|--|-----------------|-------------|-------------|------------------|-------------|-------------|
| | | | PM Peak 2026 | | | PM Peak 2026+28% | | |
| | | | 17:30-17:45 | 17:45-18:00 | 18:00-18:15 | 17:30-17:45 | 17:45-18:00 | 18:00-18:15 |
| 9 | Crossrail | Eastbound platform | Pass | Fail | Fail | Pass | Fail | Fail |
| 10 | | Westbound platform | Pass | Pass | Pass | Pass | Pass | Pass |
| 11 | | Central concourse | Pass | Pass | Pass | Pass | Pass | Pass |
| 12 | | Cross passage CP4 (Moorgate end) | Pass | Pass | Pass | Pass | Pass | Pass |
| 13 | | Cross passage CP3 (Moorgate end) | Pass | Pass | Pass | Pass | Pass | Pass |
| 14 | | Cross passage CP4a (Moorgate end) | Pass | Pass | Pass | Pass | Pass | Pass |
| 15 | | Cross passage CP3a (Moorgate end) | Pass | Pass | Pass | Pass | Pass | Pass |
| 16 | | Cross passage CP8 (Broadgate end) | Pass | Pass | Pass | Pass | Pass | Pass |
| 17 | | Cross passage CP7 (Broadgate end) | Pass | Pass | Pass | Pass | Pass | Pass |
| 18 | | Cross passage CP6 (Broadgate end) | Pass | Pass | Pass | Pass | Pass | Pass |
| 19 | | Cross passage CP5 (Broadgate end) | Pass | Pass | Pass | Pass | Pass | Pass |
| 20 | | Cross passage CP1 (Northern Line Link) | Pass | Pass | Pass | Pass | Pass | Pass |
| 21 | Cross passage CP2 (Northern Line Link) | Pass | Pass | Pass | Pass | Pass | Pass | |
| 22 | Passageway AP9 | Passageway between Crossrail platforms and Moorgate combined ticket hall | Pass | Pass | Pass | Pass | Pass | Pass |
| 23 | Passageway AP2 | Passageway between Crossrail platforms and Broadgate ticket hall | Pass | Pass | Pass | Pass | Pass | Pass |

- Key**
- (Green) - Pass. Congestion and/or flow rates are acceptable
 - (Red) - Failure due to high levels of congestion or flow rates which are significantly above the acceptance criteria
 - * (Red) - Failure due to levels of congestion or flow rates being marginally above the acceptance criteria
 - ** (Blue) Based on appraisal of average peak minute flow data extracted from dynamic Legion modelling outputs

4.6.2 Crossrail Platforms - Managed Overcrowding

Based on the output of the cancelled Crossrail train scenario, Crossrail and LU requested that additional modelling be undertaken to assess the extent of staff management required to reduce passenger congestion to an acceptable threshold. The client has proposed a hypothetical management strategy whereby passengers are rerouted via the central concourse to reach a less crowded area of the platform.

The Post LU Audit report outlines the rerouting criteria and model configuration implemented to simulate this management scenario (C138-MMD-P-RGN-C101-50001). The FDC has run the following Legion model to test this scenario:

- **2026 PM peak**
 - LIV 2026 1715-1845 PM PRM lift v05.lgm

2026 Demand Year (Cancelled Train Scenario)

Table 4-6 shows the impact of introducing a hypothetical platform management strategy for the 2026 demand year. The proposed management scenario significantly reduces the extent of overcrowding on the eastbound platform. Specifically, the duration that more than 145 people (1.62 p/m², the acceptance criteria defined by the client) wait per carriage is limited to a maximum of 1.2 minutes during the PM peak (17:15-18:45).

Additional outputs are presented in Appendix E. Specifically, maximum platform load and maximum density (per carriage) are specified, as well as Legion model output maps. Cumulative mean and cumulative high density maps (Walkway LOS and Queuing LOS), are available for the following three peak minute periods: 17:30-17:45, 17:45-18:00 and 18:00-18:15.

Table 4-6: Impact of platform management for 2026 demand year.

| | 2026 | | | | | |
|--------|----------------------------|----------------------------|-----------------------------|----------------------------|----------------------------|-----------------------------|
| | No Management | | | Managed | | |
| | Time above threshold (min) | | | Time above threshold (min) | | |
| | 1.62 * p/m ² | 1.54 ^ p/m ² | 1.25 ^^ p/m ² | 1.62 * p/m ² | 1.54 ^ p/m ² | 1.25 ^^ p/m ² |
| Car 1 | 0.0 | 0.0 | 0.0 | 0.0 | 0.0 | 0.0 |
| Car 2 | 0.0 | 0.0 | 0.0 | 0.0 | 0.0 | 0.0 |
| Car 3 | 0.0 | 0.0 | 0.0 | 0.0 | 0.0 | 0.5 |
| Car 4 | 0.0 | 0.0 | 0.4 | 0.1 | 0.3 | 2.9 |
| Car 5 | 0.1 | 0.1 | 2.8 | 1.1 | 2.0 | 6.3 |
| Car 6 | 2.5 | 4.0 | 10.2 | 1.2 | 2.0 | 7.4 |
| Car 7 | 4.6 | 7.0 | 16.4 | 0.0 | 0.1 | 4.4 |
| Car 8 | 8.3 | 9.3 | 19.4 | 1.2 | 2.8 | 6.8 |
| Car 9 | 5.9 | 9.2 | 17.9 | 0.7 | 1.9 | 6.5 |
| Car 10 | 0.0 | 0.0 | 1.5 | 0.0 | 0.0 | 0.5 |

* = Threshold at which management required
 ^ = Upper limit of platform density - Crossrail Station Platform Standard (CR-STD-305 v8.0)
 ^^ = Upper limit of platform density – LU - SPS (1-371-A4)

4.6.3 Crossrail Platforms - Identifying the Model Breakpoint

It is important to appreciate that there will be a significant period of time after the 2026 demand level, when passenger numbers will increase but the Crossrail train frequency will remain at 24 trains per hour, and thus the operational performance of the station will be worse than the modelling output has demonstrated for the 2026 demand year.

Having established that the proposed station management strategy would, to some extent, mitigate overcrowding on the eastbound platform in 2026, the client requested that further sensitivity testing be undertaken to establish when this proposed management strategy would be ineffectual in relation to future passenger demand growth. An iterative process of sensitivity analyses was proposed, and demand levels representing 2026+7%, 2026+14% and 2026+21% have been evaluated, all with respect to 24 Crossrail trains per hour.

The FDC has run the following Legion model to test each scenario:

- **2026+7% PM peak**
 - LIV 2026+07% 1715-1845 PM PRM lift simple v08.lgm
- **2026+14% PM peak**
 - LIV 2026+14% 1715-1845 PM PRM lift simple v07.lgm
- **2026+21% PM peak**
 - LIV 2026+21% 1715-1845 PM PRM lift simple v08.lgm

2026+7%, +14% and +21% Demand Year (Cancelled Train Scenario)

Figure 4-12 illustrates when it is predicted that management of the overcrowded platforms would be in 2026 and in the additional three demand scenarios (2026+7%, +14% and 21%). In all four cases, management was either required between 17:30 to 19:00 or up to a point when the model failed / stopped due to overcrowding (i.e. 2026+14% and 2026+21%).

Appendix E presents the maximum platform load and maximum density data (per carriage), as well as output maps for the 2026+7% demand year. Cumulative mean and cumulative high density maps (Walkway LOS and Queuing LOS), in relation to both a managed and unmanaged scenario, are available for the following three peak minute periods: 17:30-17:45, 17:45-18:00 and 18:00-18:15.

Figure 4-12: Timeline of management activation and demand sensitivities.

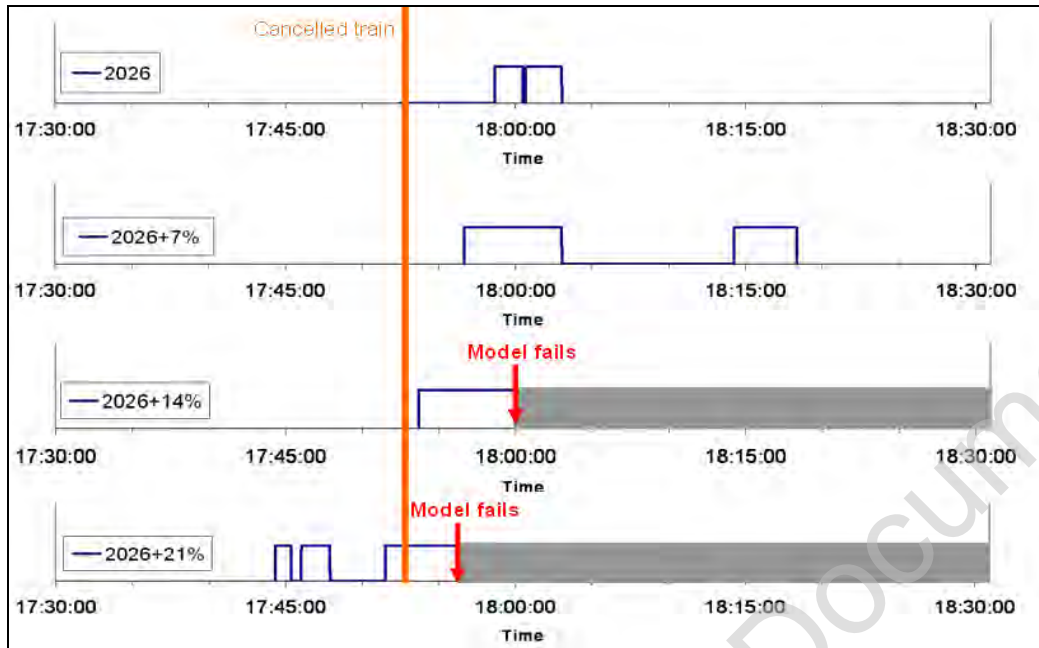

4.6.4 Summary - Cancelled Crossrail Train

Taken together, the following conclusions can be drawn about the extent of overcrowding when an eastbound Crossrail train is cancelled during the PM peak, and the hypothetical management strategy tested to mitigate congestion:

- The threshold of overcrowding (i.e. 145 passengers waiting for any one carriage, equivalent to 1.62 p/m²) was exceeded in all four demand scenarios (2026 – 2026+21%). Thus, in the event of a cancelled train, management may be required from 2026 onwards.
- Due to the extent of passenger demand, from the 2026+7% demand scenario onwards, some passengers would be unable to embark a train, even before the 17:52 cancelled train.
- During the 2026+21% demand year, the management strategy would be required before the cancelled train, indicating that management would be required even with a non-perturbed eastbound Crossrail service.
- Based on proposed management strategy in the 2026+14% or 2026+21% demand years the dynamic models failed after a cancelled train due to overcrowding on the platforms.

4.7 Crossrail Central Concourse - Totems

Additional analysis has been conducted to assess the impact of providing totems within the Crossrail central concourse area. The lighting strategy for the totems will require the introduction of thirteen units each spaced approximately 11m apart along the centre of Crossrail concourse area (refer to Appendix F). Dynamic Legion modelling of the station has been undertaken for AM and PM peak periods of the 2026 demand year, and a sensitivity test for the 2026+28% demand levels. The simulation outputs have been reviewed for normal operations of the station (i.e. non-perturbed Crossrail train service).

The FDC has run the following Legion model to test each scenario:

- 2026 AM peak:
 - LIV 2026 0800-0930 AM PRM lift v08c poles.lgm
- 2026 PM peak
 - LIV 2026 1715-1845 PM PRM lift no MS no canc'd v14c poles.lgm
- 2026+28% AM peak
 - LIV 2026+28% 0800-0930 AM PRM lift v10c poles.lgm
- 2026+28% PM peak
 - LIV 2026+28% 1715-1845 PM PRM lift no MS no canc'd v13c poles.lgm

2026 Demand Year (with Totems)

The modelling output shows very little difference in terms of density levels during the peak 15 minute. The outputs illustrate that the central concourse and cross adits operate at an acceptable level of density (i.e. Walkway LOS C or better), in the 2026 AM and PM peak periods (refer to Figure 4-13).

Sensitivity Analysis - 2026+28% Demand Year (with Column Lighting)

Similarly, the dynamic modelling output illustrates that the central concourse and cross adits operate at an acceptable level of density (i.e. Walkway LOS C or better), in the 2026+28% AM and PM peak periods.

Figure 4-13: Cumulative mean density - Walkway LOS, Crossrail central concourse and cross adits (2026 AM and PM peak, including totems).

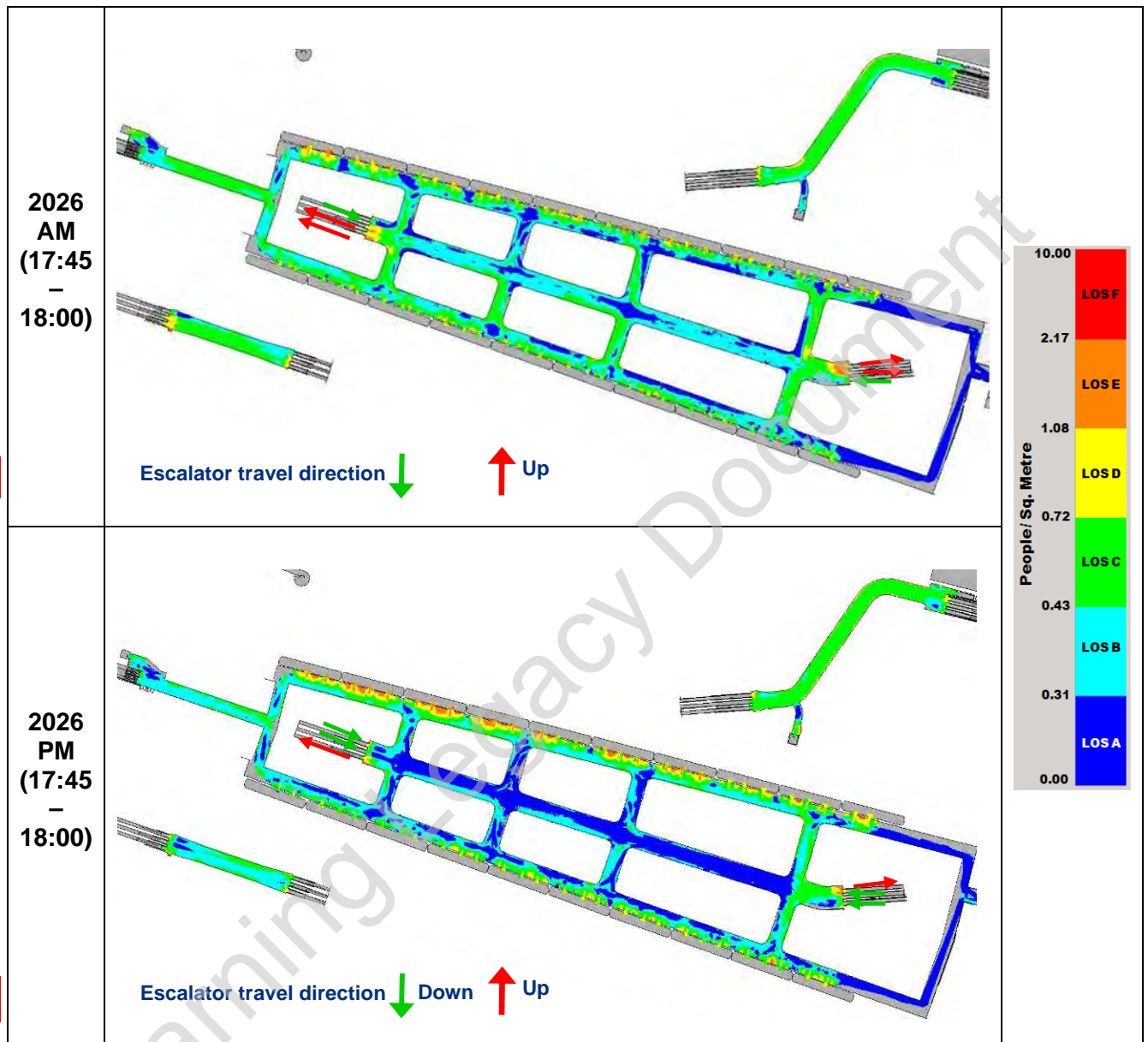

5 Conclusions

5.1 Static Analysis

Based on the CPFR 5.0 passenger demand forecasts the static analysis has highlighted that two areas of the station would be insufficient in size to cope with the anticipated volume of passengers in 2026, and four areas would be insufficient in 2026+28%:

1. The unpaid side of the new Moorgate Integrated ticket hall concourse:

| | |
|----------------------|-----------------------|
| Current design: | 215m ² |
| 2026+28% requirement | AM: 231m ² |

In order to be compliant with the LU-SPS, the required area increase is 16m². The current design area represents the absolute maximum achievable by the design team based on physical constraints. The reduced unpaid area of 16m² does not present any operational or safety concerns.

2. The new stairs connecting the Moorgate Integrated ticket hall to the Metropolitan Line westbound platform:

| | |
|----------------------|-----------|
| Current design: | 3.55m |
| 2026+28% requirement | PM: 4.00m |

In order to be compliant with the LU-SPS, the required increase in effective width is 0.450m. However, the current design width of the stairs represents the absolute maximum achievable.

3. The existing stairs connecting the Moorgate Integrated ticket hall to the Metropolitan Line eastbound platform:

| | |
|----------------------|-----------|
| Current design: | 3.23m |
| 2026 requirement | AM: 3.60m |
| 2026+28% requirement | AM: 4.61m |

In order to be compliant with the LU-SPS, the required increase in effective width is 0.370m for 2026 and an increase of 1.380m for 2026 +28%. The eastbound stair is an existing LU asset and is going to be re-furnished with new finishes as part of the ticket hall upgrade and integration works. As an existing asset, the maximum width has been achieved and as required by CPFR v5.0 is acceptable if an appropriate station management plan is implemented – refer to section 3.4.3 for mitigation measures.

4. The new stairs connecting the NLL (AP6) and the Northern Line platforms:

| | |
|----------------------|-----------|
| Current design: | 2.40m |
| 2026 requirement | AM: 2.70m |
| 2026+28% requirement | AM: 3.46m |
| | PM: 2.84m |

In order to be compliant with the LU-SPS, the required increase in effective width is 0.300m for 2026 and an increase of 1.060m for 2026 +28%. The stairway is positioned to emerge between the two Northern Line platforms in order to provide a connection between AP6 and the Northern Line platforms. Due to the tight site constraints of the existing Northern Line tunnels / platforms, no increase in width of the staircase can be achieved. Accordingly, this area of the station is subject to a concession (C138-003E/SP0113).

5.2 Dynamic Modelling

The output of the dynamic passenger modelling has confirmed the findings of the static analysis. However, it should be noted that several areas of the station, such as the FCC platforms, Northern Line platforms, and Liverpool Street ticket hall B were outside the scope of the static analysis, and a comparison could therefore not be drawn between the two analyses. The dynamic modelling has therefore highlighted further locations where the operational conditions of the station would be unacceptable, particularly with respect to the sensitivity tests undertaken.

Below is a brief summary of the areas of the station where the dynamic modelling has indicated that density levels or passenger flow rates would be unacceptable based on the acceptance criteria defined within the Crossrail Passenger Modelling Guidelines (i.e. the LU - Station Planning Standard, 1-371-A4, and / or the overarching Crossrail Station Planning Standard – Platforms, CR-STD-305, version 8.0):

2026 AM and PM Demand (without a cancelled Crossrail train)

The operational performance of the following areas of the station has been identified as unacceptable with respect to 2026 passenger demand:

- **Existing stairs connecting the Moorgate Integrated ticket hall to the Metropolitan Line eastbound platform**

During the 2026 AM peak, the average flow rate on the eastbound platform stairs (32pmm) exceeds the two-way stair threshold of 28pmm. However, as this stairway mainly operates as a one-way stairway, the one-way threshold of 35pmm would be more appropriate. As the flow rate exceeds the one-way threshold of 35pmm for nearly 7 of the peak 15 minutes, the eastbound stair flow rates are considered to be marginally unacceptable.

- **The new stairs connecting the NLL (AP6) and the Northern Line platforms**

During the 2026 AM peak, the average flow rate on the stairs to the Northern Line Link equates to 29.5pmm, and is marginally in excess of the LU-SPS two-way stair threshold of 28pmm. However, this flow is greater than the maximum recommended flow rate for nearly 9 minutes out of the peak 15 minutes.

- **Existing FCC platforms**

During the 2026 AM peak period, density on the FCC platforms is non-compliant (i.e. greater than Walkway LOS C), reaching Walkway LOS E and LOS F. In addition, density on the FCC Platforms is also greater than Queuing LOS C for up to 5 of the peak 15 minutes.

Sensitivity Analysis: AM and PM 2026+28% Demand (without a cancelled Crossrail train)

In addition to the three areas identified as having a non-compliant operational performance in the 2026 demand year, the following areas were found to be operationally non-compliant based on 2026+28% demand levels:

- **Moorgate Integrated ticket hall - westbound stairs**

During the 2026+28% PM peak, the average flow rate on the westbound platform stairs (i.e. 30.8pmm) marginally exceeds the two-way threshold. However, this stair mainly operates as a one-way stairway; therefore the one-way threshold of 35pmm would be more appropriate. As the flow rate exceeds the one-way threshold of 35pmm for three of the peak 15 minutes, the westbound stair flow rates are considered to be marginally unacceptable.

- **The new stairs and cross passage linking the Northern Line platforms to the Northern Line Link**

During the 2026+28% AM, the stair flow rate is an average of 40 people per metre per minute, which is significantly greater than the two-way stair threshold of 28pmm, and is therefore unacceptable. Indeed the flow rate is in excess of 28pmm for 14 of the peak 15 minutes, which results in queuing at the foot and head of the stairs to the NLL. Moreover, minor blockages occur at the junction between the FCC down escalator and the NLL stairs due to conflicts in bi-directional flow. This congestion is likely to be a safety concern, particularly with respect to the flow of passengers via the down direction escalator from the FCC platforms.

- **Existing Moorgate ticket hall**

During the 2026+28% AM peak, density reaches Walkway LOS D in the passageway between the ticket hall and the Metropolitan, Circle and Hammersmith & City eastbound platform. At this location density exceeds Walkway LOS C for up to 7.5 minutes out of the peak 15 minutes. Moreover, density levels reach Queuing LOS D at the NL and Met gatelines, and are above Queuing LOS C for up to 10 minutes of the peak 15 minutes.

- **Existing Liverpool Street ticket hall B (Paid Side)**

In the 2026+28% AM and PM peaks, congestion reaches Walkway LOS D on the paid side of the ticket hall, at the entrance of the adits linking ticket hall B to the Metropolitan, Hammersmith & City and Circle Line platforms. However, these isolated areas of congestion are small and do not result in significant queuing.

It should be noted that the Metropolitan, Hammersmith & City and Circle Line platforms themselves were outside the scope of this study, and these areas have, therefore, not been assessed in terms their operational performance.

- **Passageway AP8**

During both 2026+28% AM and PM peaks, density within AP8 marginally exceeds Walkway LOS C in AP8 for up to 5 minutes of the peak 15 minutes.

Additional Sensitivity Analysis: 2026 and 2026+28% PM Demand (with a cancelled Crossrail train)

Sensitivity testing has shown that the only noticeable change in operational performance within the station occurs on the Crossrail platforms. A cancelled train on the eastbound platform in the PM peak would represent a 'worst case' scenario, due to the high levels of passenger demand.

- **Eastbound Crossrail platform – Unmanaged Overcrowding**

Both the 2026 PM and 2026+28% PM scenarios show significant levels of congestion when a cancelled train on the eastbound service was modelled. In both the peak 15 minutes (17:45-18:00) and the following 15 minutes (18:00-18:15) congestion levels reach Walkway LOS E and F (Queuing LOS C and D) across the entire width, and a along a significant proportion of the platform. As a consequence of this congestion, circulation at the back of the platform is significantly effected.

- **Eastbound Crossrail platform – Managed Overcrowding**

During the 2026 PM peak, the introduction of a hypothetical passenger management strategy significantly reduces the extent of overcrowding. Specifically, the duration that more than 145 people (1.62 p/m², the acceptance criteria defined by the client) wait per carriage is limited to a maximum of 1.2 minutes.

It is important to appreciate that there will be a significant period of time after the 2026 demand level, when passenger numbers will increase but the Crossrail train frequency will remain at 24 trains per hour, and thus the operational performance of the station will be worse than the modelling output has demonstrated for the 2026 demand year.

Further sensitivity testing has been undertaken to establish when this proposed management strategy would be ineffectual in relation to a cancelled eastbound Crossrail train and the following future passenger demand growth (2026+7%, 2026+14% and 2026+21%). Based on this analysis, the following conclusions could be drawn:

- **Eastbound Crossrail platform – Model break point**

- The threshold of overcrowding (i.e. 145 passengers waiting for any one carriage, equivalent to 1.62 p/m²) is exceeded in all four demand scenarios (2026 – 2026+21%), Thus, in the event of a cancelled train, management may be required from 2026 onwards.
- Due to the extent of passenger demand, from the 2026+7% demand scenario onwards, some passengers may be unable to embark, even before a cancelled train.
- During the 2026+21% demand year, staff management may be required with even a normal Crossrail service.
- Even with the proposed staff management strategy, the dynamic models fail after a cancelled train due to overcrowding in the 2026+14% or 2026+21% demand years.

6 Further Analysis

With respect to the findings of this study, the following (non-exhaustive) list of sensitivity analysis could be undertaken to further explore the affect of the modelling assumptions on the operational performance of the station.

- In line with the C160 rolling stock dwell time modelling, the flow rate of alighting and boarding passengers could be constrained to a maximum limit. At present, the exchange of passengers significantly exceeds the flow rates observed in studies of similar rolling stock, and therefore represents an overly optimistic representation of reality.

This change may result in less passengers being able to alight and board in the modelled dwell time, which would increase the number of passenger left behind on the platform. The density levels on platforms, which are currently borderline in some scenarios, may therefore increase further.

Additionally, this sensitivity analysis would help establish whether a longer Effective Door operating Time (EDOT) was required at Liverpool Street Station in order to permit sufficient passenger exchange, though this is likely to affect the station dwell time, and possibly the train timetable.

- The passenger waiting process simulated with respect to the PEDs on the Crossrail platforms, and the predicted distribution of passenger (i.e. boarding profiles) along the platforms, may not be representative of future real-life behaviour. As part of the modelling audit for all the central Crossrail stations, LU has requested that Crossrail model passenger waiting behaviour in more detail to explore the potential effect of the PEDs. Based on the findings of this analysis, sensitivity analysis should be considered to test the impact on Liverpool Street Station.
- While a cancelled Crossrail train has been modelled, to date no perturbation to the LU train services has been explored. Modelling of a cancelled train on the Metropolitan, Hammersmith & City, and Circle Line could be undertaken to determine the impact on the existing Moorgate ticket halls.
- The Metropolitan, Hammersmith & City and Circle Line platforms at Liverpool Street Station were outside the scope of this study. These areas should be assessed in terms their operational performance.

7 Assumptions Data

The following Excel spreadsheets document the input data and modelling assumptions of the main base Legion models:

2026 - AM

- 2010-10-12 ACS Liverpool Street Moorgate LU CRL Station Complex (2026AM) v1.5.xls

2026 - PM

- 2010-10-12 ACS Liverpool Street Moorgate LU CRL Station Complex (2026PM) v1.3.xls

2026+28% - AM

- 2010-10-12 ACS Liverpool Street Moorgate LU CRL Station Complex (2026 plus 28% AM) v1.3.xls

2026 +28% - PM

- 2010-10-12 ACS Liverpool Street Moorgate LU CRL Station Complex (2026 plus 28% PM) v1.3.xls

Reference Documents

CR-XRL-Z-GPR-CR001-00004: Crossrail Programme Functional Requirements, August 2010 (version 5.0).

CR-EG-LIV-X-RT-0001: C138 Liverpool Street Modelling Methodology Report, November 2009, version 2.0.

CR/QMS/OPS/GN/0010: Pedestrian Modelling Guidelines, May 2008 (version 3.0).

LUL (2010), Station Planning Standard (1-371-A4), London Underground Limited, London.

LUL (2009), Station Modelling with Legion: Best Practice Guide, London Underground Limited, London.

C138-MMD-A-RGN-C101-00002: C138 Liverpool Street Station, Revisions to the Pedestrian Modelling Assumptions.

CRL1-XRL-06-STD-CR001-00022: Station Planning Standard – Platforms (CR-STD-305, version 8.0).

C138-MMD-P-RGN-C101-50001: C138 – Liverpool Street Station – Dynamic Passenger Modelling - Post LU Audit Report

C138-MMD-A-RIA-C101-00002: C138 – Liverpool Street Station – Revised Passenger Demand – Impact Assessment – Dynamic Legion Modelling

CRL1-XRL-T1-RGN-CR001-0002: Crossrail Station Demand Matrices: 2010 Forecast (issue 1.8).

CRL1-XRL-T1-RGN-CRG02-00001: Crossrail Demand Peaking Factors (Issue 1, February 2011)

C138-MMD-A-DDA-C101-50001: Volume 2A, Architectural Drawings

C138-MMD-A-DDA-C101-50002: Volume 2B, Architectural Drawings

Appendix A: Revised Forecast Passenger Demand Figures

Table A-0-1: Moorgate AM peak passenger demand – 2026 with Crossrail

| 2026 With Crossrail - AM Peak Demand at Moorgate | | | | | | | | | | |
|--|---------------------------|--------------------------------|----------------------|----------------------|------------------------|------------------------|---------------|-------------------------|-------------------------|--------------|
| MOORXR153RuAM | MOORGATE LUL TICKET HALLS | MOORGATE CROSSRAIL TICKET HALL | MOORGATE METH&C (WB) | MOORGATE METH&C (EB) | MOORGATE NORTHERN (NB) | MOORGATE NORTHERN (SB) | MOORGATE WAGN | MOORGATE CROSSRAIL (EB) | MOORGATE CROSSRAIL (WB) | TOTAL |
| MOORGATE LUL TICKET HALLS | - | - | 2400 | 1150 | 1200 | 500 | 200 | - | - | 5450 |
| MOORGATE CROSSRAIL TICKET HALL | - | - | - | - | - | - | - | 450 | 350 | 800 |
| MOORGATE METH&C (WB) | 2600 | - | - | - | 200 | 250 | 100 | 100 | 150 | 3400 |
| MOORGATE METH&C (EB) | 10200 | - | - | - | 350 | 600 | 150 | 1900 | 0 | 13200 |
| MOORGATE NORTHERN (NB) | 5550 | - | 500 | 250 | - | - | 450 | 550 | 50 | 7350 |
| MOORGATE NORTHERN (SB) | 4850 | - | 200 | 600 | - | - | 50 | 1150 | 100 | 6950 |
| MOORGATE WAGN | 2100 | - | 50 | 1900 | 200 | 4800 | - | 1600 | 500 | 11150 |
| MOORGATE CROSSRAIL (EB) | - | 3150 | 0 | 0 | 150 | 50 | 50 | - | - | 3400 |
| MOORGATE CROSSRAIL (WB) | - | 4850 | 3450 | 0 | 2500 | 1200 | 500 | - | - | 12500 |
| TOTAL | 25300 | 8000 | 6600 | 3900 | 4600 | 7400 | 1500 | 5750 | 1150 | 64200 |

Table A-0-2: Moorgate PM peak passenger demand – 2026 with Crossrail

| 2026 With Crossrail - PM Peak Demand at Moorgate | | | | | | | | | | |
|--|---------------------------|--------------------------------|----------------------|----------------------|------------------------|------------------------|---------------|-------------------------|-------------------------|--------------|
| MOORXR153RuPM | MOORGATE LUL TICKET HALLS | MOORGATE CROSSRAIL TICKET HALL | MOORGATE METH&C (WB) | MOORGATE METH&C (EB) | MOORGATE NORTHERN (NB) | MOORGATE NORTHERN (SB) | MOORGATE WAGN | MOORGATE CROSSRAIL (EB) | MOORGATE CROSSRAIL (WB) | TOTAL |
| MOORGATE LUL TICKET HALLS | - | - | 11900 | 3200 | 3750 | 4200 | 3450 | - | - | 26500 |
| MOORGATE CROSSRAIL TICKET HALL | - | - | - | - | - | - | - | 3900 | 2500 | 6400 |
| MOORGATE METH&C (WB) | 2050 | - | - | - | 350 | 750 | 1100 | - | - | 4250 |
| MOORGATE METH&C (EB) | 1450 | - | - | - | 50 | 400 | 50 | 3250 | - | 5200 |
| MOORGATE NORTHERN (NB) | 1250 | - | 350 | 400 | - | - | 1600 | 1150 | 50 | 4800 |
| MOORGATE NORTHERN (SB) | 1750 | - | 250 | 150 | - | - | 250 | 2350 | 150 | 4900 |
| MOORGATE WAGN | 300 | - | 150 | - | - | 500 | - | 450 | 50 | 1450 |
| MOORGATE CROSSRAIL (EB) | - | 900 | - | 150 | 100 | 0 | 450 | - | - | 1600 |
| MOORGATE CROSSRAIL (WB) | - | 1150 | 1800 | 100 | 1050 | 500 | 1500 | - | - | 6100 |
| TOTAL | 6800 | 2050 | 14450 | 4000 | 5300 | 6350 | 8400 | 11100 | 2750 | 61200 |

Table A-0-3: Liverpool Street with Broadgate ticket hall AM peak passenger demand – 2026 with Crossrail

| 2026 With Crossrail - AM Peak Demand at Liverpool Street with Broadgate Ticket Hall | | | | | | | | | | | |
|---|----------------------------|------------------------------|-------------------------------|-----------------------|-------------------------|-------------------------|---------------------|---------------------|---------------------------|---------------------------|--------------|
| LIVXR153RuAM | LIV ST TH C (CENTRAL LINE) | LIV ST TH B (MAIN CONCOURSE) | LIV ST TICKET HALL A (ARCADE) | BROADGATE TICKET HALL | LIVERPOOL ST CENTRAL EB | LIVERPOOL ST CENTRAL WB | LIVERPOOL ST MET WB | LIVERPOOL ST MET EB | LIVERPOOL ST CROSSRAIL EB | LIVERPOOL ST CROSSRAIL WB | TOTAL |
| LIV ST TH C (CENTRAL LINE) | - | - | - | - | 300 | 2350 | - | - | - | - | 2650 |
| LIV ST TH B (MAIN CONCOURSE) | - | - | - | - | 1400 | 2000 | 7300 | 3850 | 2200 | 2650 | 19400 |
| LIV ST TICKET HALL A (ARCADE) | - | - | - | - | 100 | 50 | 50 | 100 | 100 | 50 | 450 |
| BROADGATE TICKET HALL | - | - | - | - | 150 | 150 | 0 | 100 | 100 | 300 | 800 |
| LIVERPOOL ST CENTRAL EB | 4050 | 1450 | 950 | 2000 | - | - | 0 | 300 | 0 | 0 | 8750 |
| LIVERPOOL ST CENTRAL WB | 3300 | 1650 | 700 | 2150 | - | - | 1200 | 200 | 0 | 250 | 9450 |
| LIVERPOOL ST MET WB | - | 1300 | 2350 | 0 | 50 | 0 | - | - | 0 | 0 | 3700 |
| LIVERPOOL ST MET EB | - | 6750 | 950 | 1900 | 1300 | 0 | - | - | 0 | 0 | 10900 |
| LIVERPOOL ST CROSSRAIL EB | - | 1300 | 850 | 2850 | 250 | 0 | 0 | 250 | - | - | 5500 |
| LIVERPOOL ST CROSSRAIL WB | - | 1900 | 500 | 2700 | 0 | 0 | 0 | 0 | - | - | 5100 |
| TOTAL | 7350 | 14350 | 6300 | 11600 | 3550 | 4550 | 8550 | 4800 | 2400 | 3250 | 66700 |

Table A-0-4: Liverpool Street with Broadgate ticket hall PM peak passenger demand – 2026 with Crossrail

| 2026 With Crossrail - PM Peak Demand at Liverpool Street with Broadgate Ticket Hall | | | | | | | | | | | |
|---|----------------------------|------------------------------|-------------------------------|-----------------------|-------------------------|-------------------------|---------------------|---------------------|---------------------------|---------------------------|--------------|
| LIVXR153RuPM | LIV ST TH C (CENTRAL LINE) | LIV ST TH B (MAIN CONCOURSE) | LIV ST TICKET HALL A (ARCADE) | BROADGATE TICKET HALL | LIVERPOOL ST CENTRAL EB | LIVERPOOL ST CENTRAL WB | LIVERPOOL ST MET NB | LIVERPOOL ST MET SB | LIVERPOOL ST CROSSRAIL EB | LIVERPOOL ST CROSSRAIL WB | TOTAL |
| LIV ST TH C (CENTRAL LINE) | - | - | - | - | 250 | 2850 | - | - | - | - | 3100 |
| LIV ST TH B (MAIN CONCOURSE) | - | - | - | - | 1300 | 2400 | 7400 | 3200 | 2100 | 2500 | 18900 |
| LIV ST TICKET HALL A (ARCADE) | - | - | - | - | 50 | 50 | 100 | 50 | 100 | 50 | 400 |
| BROADGATE TICKET HALL | - | - | - | - | 5550 | 2950 | 2850 | 0 | 3200 | 2750 | 17300 |
| LIVERPOOL ST CENTRAL EB | 4650 | 1600 | 1050 | 150 | - | - | 0 | 0 | 0 | 0 | 7450 |
| LIVERPOOL ST CENTRAL WB | 1300 | 650 | 300 | 50 | - | - | 1400 | 100 | 0 | 300 | 4100 |
| LIVERPOOL ST MET NB | - | 1500 | 2500 | 150 | 200 | 450 | - | - | 0 | 300 | 5100 |
| LIVERPOOL ST MET SB | - | 7800 | 1100 | 0 | 1400 | 0 | - | - | 0 | - | 10300 |
| LIVERPOOL ST CROSSRAIL EB | - | 1450 | 1450 | 700 | 300 | 0 | 0 | 0 | - | - | 3900 |
| LIVERPOOL ST CROSSRAIL WB | - | 1500 | 1200 | 150 | 0 | 0 | 0 | 0 | - | - | 2850 |
| TOTAL | 5950 | 14500 | 7600 | 1200 | 9050 | 8700 | 11750 | 3350 | 5400 | 5900 | 73400 |

Appendix B: Assumed Moorgate Ticket Hall Passenger Routing

2010 RODS AM and PM passenger entry data for Moorgate station was provided by London Underground, who advised that the AM exit rates (Figure B-0-1) could be defined from the PM entry, and PM exit by the AM entry (Figure B-0-2).

Figure B-0-1: Moorgate AM station entry - Destination of passengers by proportion, derived from 2010 RODS data.

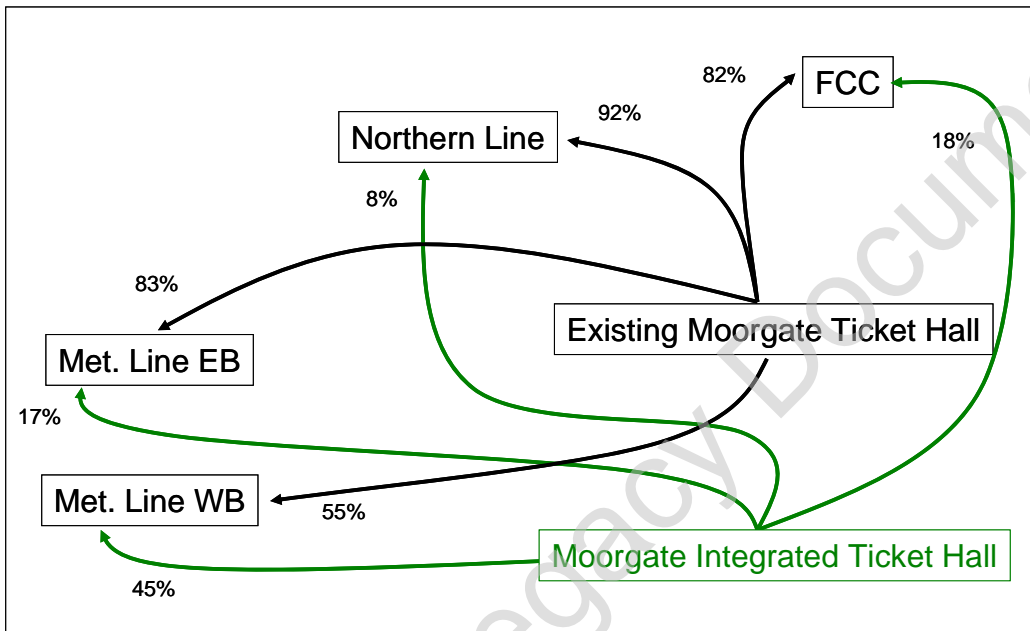
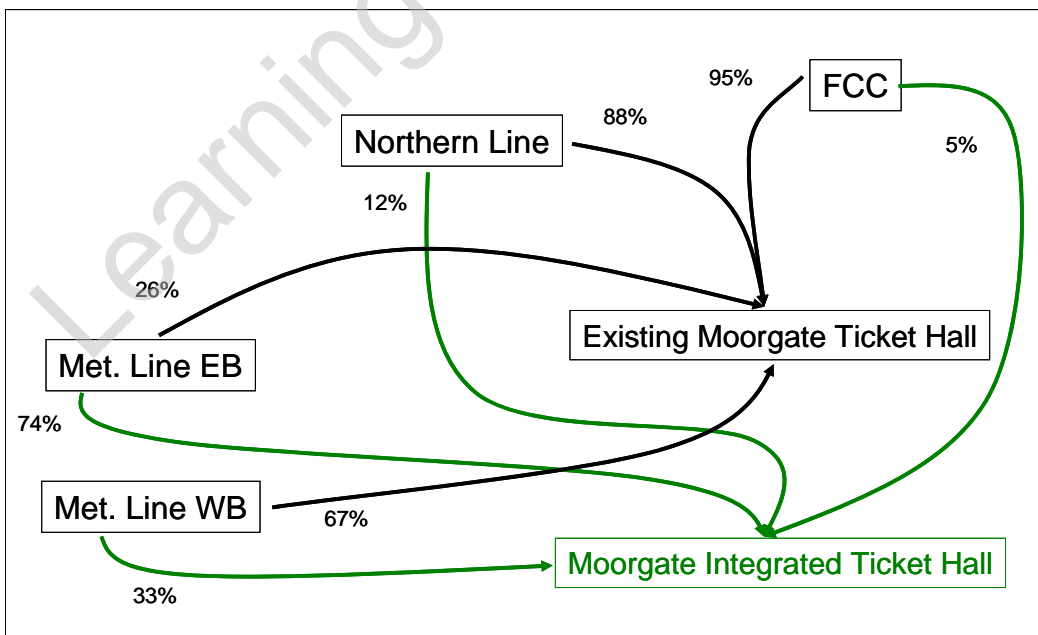

Figure B-0-2: Moorgate AM station exit - Destination of passengers by proportion, derived from 2010 RODS data.





Appendix C: London Underground Audit Letter (Ref. G22-564)

Learning Legacy Document



Ref: G22-564

Station Modelling Team

London Underground
Floor 2N,
55 Broadway
London
SW1H 0BD

23 November 2010

email [REDACTED]

www.tfl.gov.uk/tube

Dear [REDACTED]

Re: Liverpool Street/Moorgate LU/CRL Station Complex - 2026+28% AM and PM Peak Model Audit

Please find below a summary of the issues that have been discovered following the detailed audit of the Legion modelling work conducted for the '2026 impacts assessment' work stream for Liverpool Street/Moorgate station. These issues are due to be discussed at our 'Post Audit Meeting' currently scheduled for the afternoon of Tuesday November 23rd at London Underground offices.

The audit constituted interrogating the 2026+28% AM and PM Peak models and was split roughly into three discrete stages:

- **Stage 1: Input Audit;** ensuring the assumptions detailed in the Assumption Cover Sheet for each model were being upheld
- **Stage 2: Logic Audit;** ensuring the architecture and internal model logic in the Legion Model builder were both accurate and sensible. Also making sure that Best Practice Guides/ guidelines were being taken into account.
- **Stage 3: Output Audit;** involved simulating an Origin-Destination matrix and producing a rival .RES file to ensure the FDC model run results were representative

The list of issues, that was a by-product of the audit, can be seen below. These have been given provisional, pre-discussion categories of significant/insignificant/unknown. A concise list of these issues which will inform discussion (and determine whether the significant issues may constitute a model re-run) at the Post Audit Meeting can be seen on the final page. There will be also be a mini audit on the 2026 models that will take place soon after the Post Audit Meeting to see if there any further issues that have not been discovered in relation to these models, due to complexity of this station it is just the issues coming from +28% audit that are being shown in this note.

LST1: Boarding profile assumption diagram has been changed in the previously agreed Assumption Cover Sheet to accommodate a new position for 10 car trains but each respective platform entrance profile has stayed the same [SIGNIFICANT]

The boarding profiles produced in the original ACS were with the stopping positions contained in the accompanying diagram in mind. If the stopping positions changes all of a sudden then this particular

Registered office is as above.

Registered in England and Wales,
Company Number 1900907

London Underground Limited is a company controlled by a local authority within the meaning of Part V Local Government and Housing Act 1989. The controlling authority is Transport for London.



assumption needs to be re-addressed. The Assumption Cover Sheet (a record of all assumptions agreed between LU and CRL) has been changed.

Before:

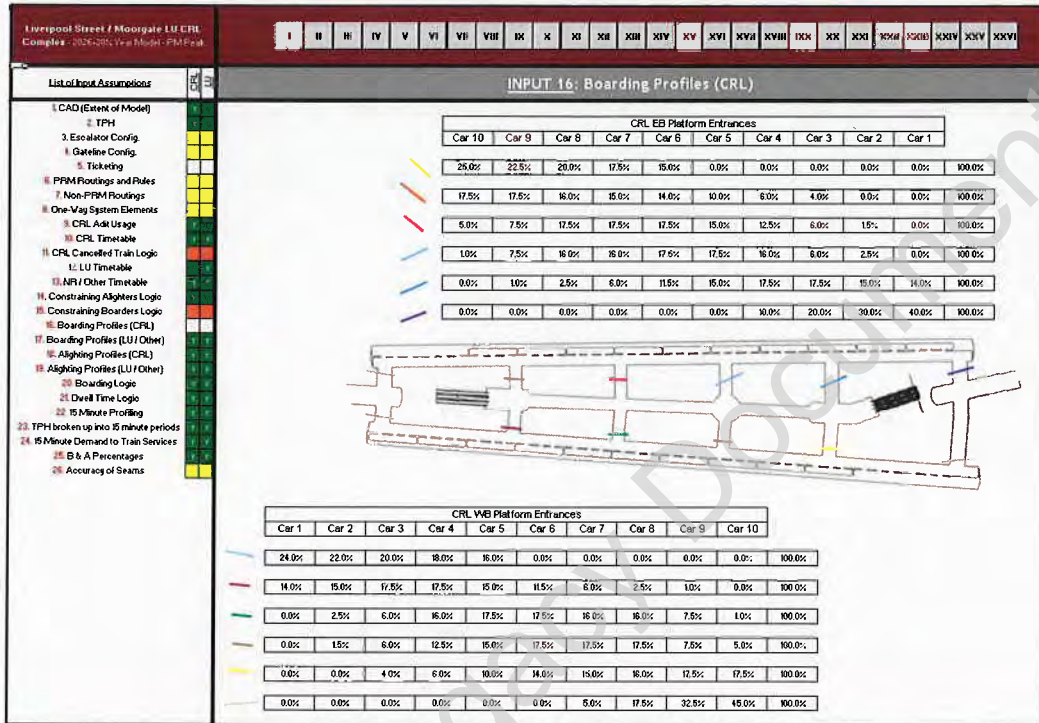

After:

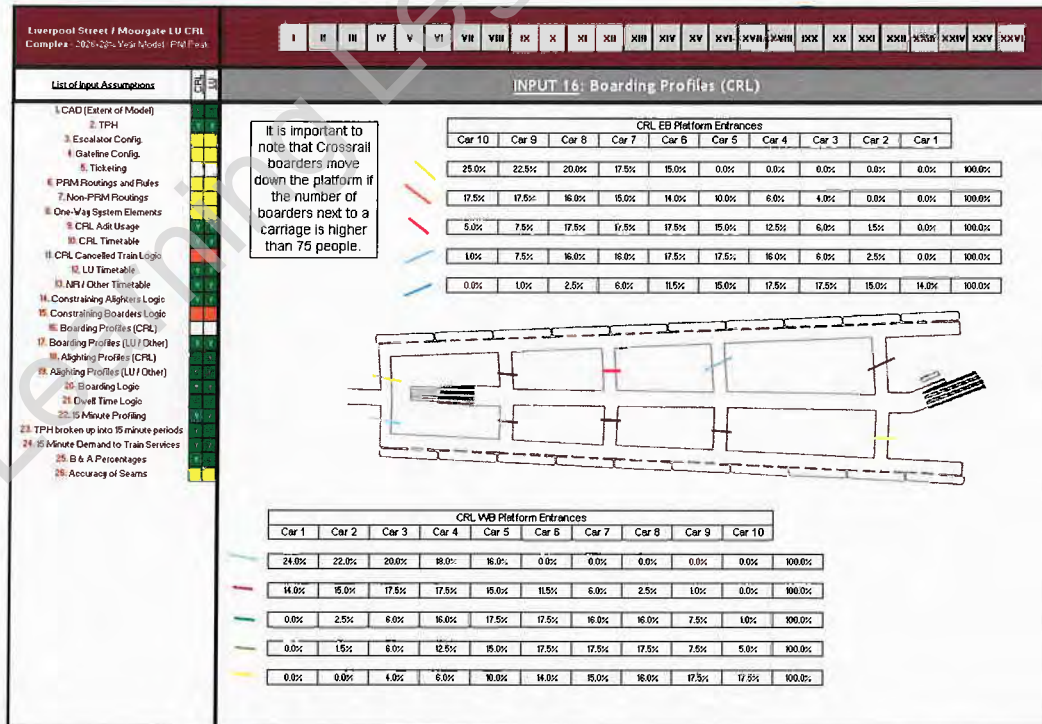

LST2: Passengers migrate down the CRL EB platform and do not abide by the boarding logic contained in the Original Assumption Cover Sheets. This migration paints the best picture of this platform but is not guaranteed to hold true in reality [SIGNIFICANT]

“However, this simulated representation of passenger behaviour is likely to represent an optimal or ideal scenario that may not occur in reality. In this respect the operational performance of the eastbound platform may be worse (i.e. congestion higher) than the modelling output indicates.” - CI38-MMD-A-RIA-CI01-00002 LIS Revised Passenger Demand - Impact Assessment - Dynamic Legion Model (Rev 2.0 - 2010-10-20)

The origins/rationale behind this migration logic needs to be explained in greater detail; e.g. ‘30 people’ is the parameter in the AM Peak +28% model versus ‘75 people’ is the parameter in the PM Peak + 28% model before a passenger decides to move down the platform. If consulted, LU might have been able to come up with an alternative approach to inform discussions which may have saved time and resource.

It has been noted that under a cancelled and non-cancelled train scenario these platforms are deemed unacceptable at 2026+28% in the PM Peak but at what point into the future in these two scenarios does this mitigation need to happen for these platforms to be operable?

CPFR v5 Excerpt: “As a general principle, areas which are dedicated to Crossrail (Platforms, new ticket halls and associated vertical circulation) shall either be sized to reflect 2026 demand +28% or shall have passive provision which would enable this demand to be met without the station having to be closed (or operating with severely degraded capacity for a protracted period)... If this test indicates that elements of the station cannot meet this level of demand, work shall be done:

a) To identify which elements become unacceptably overcrowded and the approximate date when this occurs....”

Walkway LOS CMD Plot, 2026+28% PM PEAK (With Cancelled Train) 1745-1800hrs

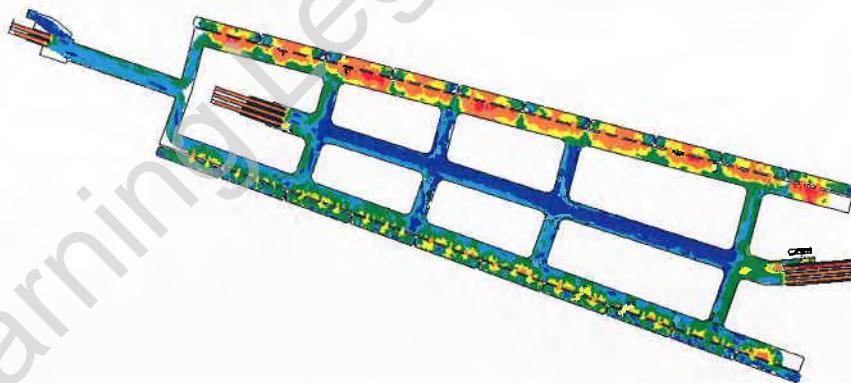

Queueing LOS CMD Plot, 2026+28% PM PEAK (With Cancelled Train) 1745-1800hrs

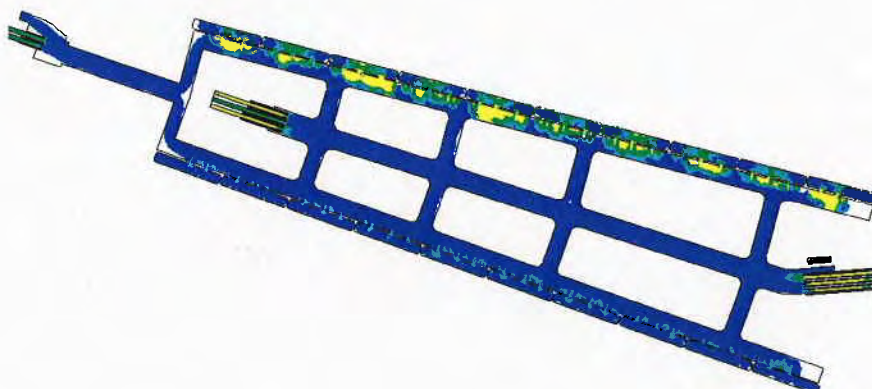



Time Spent Above 1.25m²/pax, 2026+28% PM PEAK (With Cancelled Train) 1745-1800hrs – or Time Spent Above 0.8 pax / m² [as per SPSG]



Time Spent Above 0.575m²/pax, 2026+28% PM PEAK (With Cancelled Train) 1745-1800hrs – i.e. MID POINT LOS C against a Walkway LOS [as per approx. position within interval of the SPSG flow rate of 40 pax/min]



LST3: Lift Logic in places (e.g. Moorgate Integrated Ticket Hall) appears not to follow the recommendations in the LU Legion Best Practice Guide [SIGNIFICANT]

Unsure from interrogating the model whether the lift logic (e.g. dwell time per floor, use of waiting zones, directional modifiers etc.) has been implemented accurately and consistently in all locations. The two screenshots below (with all Legion Objects visible) show two lifts that have no waiting zones attributed to them suggesting passengers instantaneously move from one level to the next without delay.

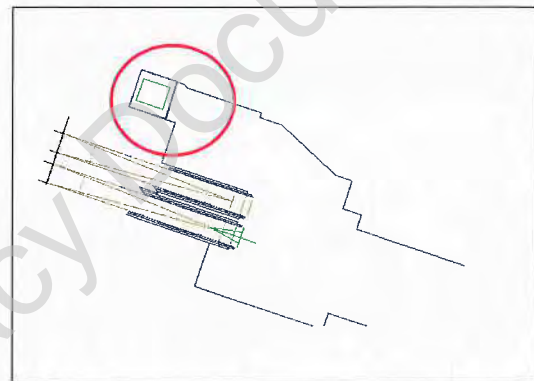
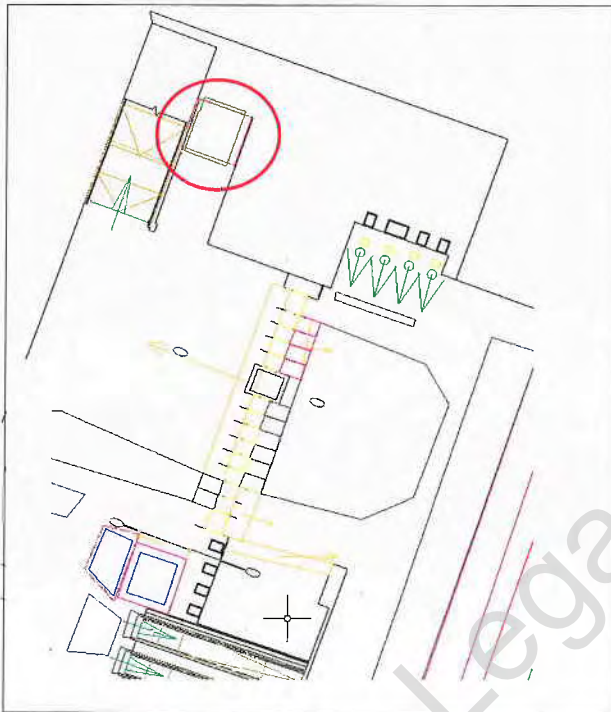

Other points of note include:

- All lift associated Event Profiles are 'On' for a period of 20s, so dwell time per floor is not 40s as suggested in the CRL Modelling Guidelines

"PRM types A, B, D and E should be routed via PRM lifts. Cycle times for lifts should assume a stop time per floor of 40 seconds, and a vertical speed of 1.4 metres per second (TfL BCDM) ..." (CRL-22005-LUCT-INT-00049 Pedestrian+Modelling+Guidelines v4 0)

- There are no CAD lines representing the width of the lift doors for realistic boarding and alighting interaction / timings
- There is no logic to send passengers back into the waiting zone if they are unable to get in the lift

Example Cycle from 'Lift B' extracted from 2026+28% PM Peak Model can be seen below:

| | | On | Off | Event Duration | Time Between Events | Effective Door Open to Door Close Time |
|--------------|---------|----------|----------|----------------|---------------------|--|
| MET WB to TH | {Enter} | 17:17:49 | 17:18:08 | 00:00:19 | - | |
| | {Up} | 17:18:12 | 17:18:31 | 00:00:19 | 00:00:04 | |
| TH to MET WB | {Enter} | 17:18:32 | 17:18:51 | 00:00:19 | 00:00:01 | 00:00:24 |
| | {Down} | 17:18:55 | 17:19:14 | 00:00:19 | 00:00:04 | |
| MET WB to XR | {Enter} | 17:19:15 | 17:19:34 | 00:00:19 | 00:00:01 | 00:00:22 |
| | {Down} | 17:19:36 | 17:19:55 | 00:00:19 | 00:00:02 | |
| XR to MET WB | {Enter} | 17:19:56 | 17:20:15 | 00:00:19 | 00:00:01 | 00:00:22 |
| | {Up} | 17:20:17 | 17:20:36 | 00:00:19 | 00:00:02 | |
| MET WB to TH | {Enter} | 17:20:38 | 17:20:57 | 00:00:19 | 00:00:02 | 00:00:25 |
| | {Up} | 17:21:01 | 17:21:20 | 00:00:19 | 00:00:04 | |



LST4: Escalator Configurations and associated logic around the Northern Line TH in the PM Peak model [SIGNIFICANT]

Having run through the escalator configurations (ACS #3) with the Operational Task Manager for this station the following set of escalators came out as the only one that did not marry up with his expectations on how the escalators should be configured:

NL PsgWay to/from Northern Line TH:

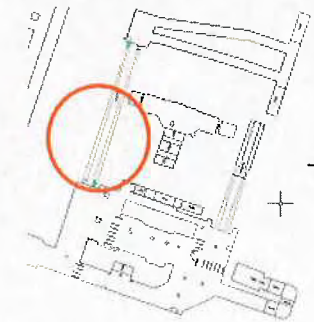

Location:
 Northern Line TH

| | |
|------|----------|
| UP | 0 |
| DOWN | 2 |
| | <u>2</u> |

NL PsgWay to/from Northern Line TH:

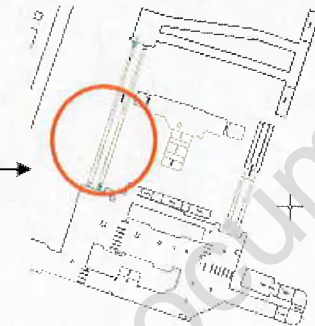

Location:
 Northern Line TH

| | |
|------|----------|
| UP | 1 |
| DOWN | 1 |
| | <u>2</u> |

N.B. Fire strategy dictates in places that there needs to be one escalator on the Up in a bank of 2 or more at all times of the day.

The logic around the use of the spiral stair as well in the PM Peak model has also been questioned, in particular why ALL MET to FCC passengers (including PRM Types D and E, Large Encumbrance and Buggys) all use these spiral stairs:



LST5: UTS Gateline throughput assumed in the 2026 +28% AM Peak Models [UNKNOWN]

This has been noted and discussed several times before. By the time of the Post Audit Meeting we hope to have some provisional results from current day CCTV footage currently being analysed within LUCT (noted is the FDC's offer for assistance with collating results).

1.8secs delay at the UTS gate is recommended in the Legion Best Practice Guide to represent 25 passengers per minute throughput. In the 2026+28% AM Peak model the assumption has been made to apply a 1.1sec delay to represent 35 passengers per minute. How did the 1.1sec figure come about?

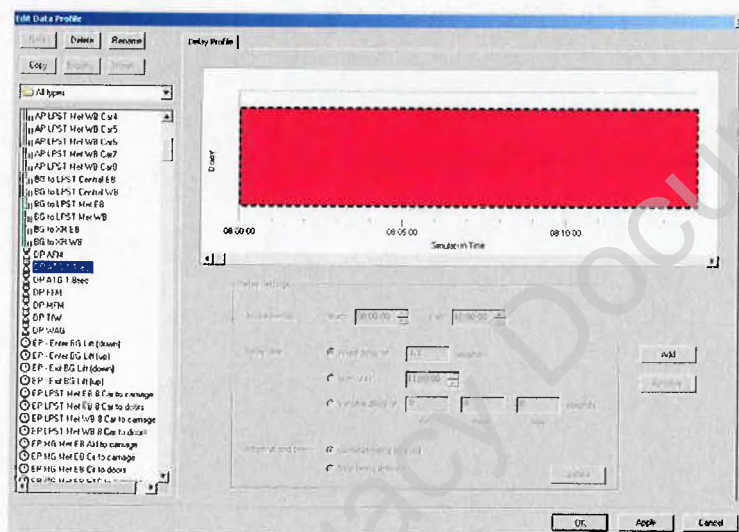

LST6: Further explanation over the justification for No Cancelled Train being present in the AM Peak models [UNKNOWN]

“The Crossrail base 2016 +35% demand Legion models use a perturbed train service on Crossrail platforms, including one train cancellation in the peak 15 minute period. This train service should continue to be used as a base scenario, unless an alternative train service is provided by CRL.” (CRL-22005-LUCT-INT-00049 Pedestrian+Modelling+Guidelines v4 0)

From reading the accompanying report - that was delivered with the models for audit - there is some explanation behind why there is no cancelled train in the AM Peak, however, would welcome to opportunity to discuss in more detail the rationale.



LST7: Cancelled train logic is evident but only partially captured by interrogating model [UNKNOWN]
 A greater explanation behind the theory behind the cancelled train logic on CRL platforms is required. The figures below from an Event and Arrival Profile show how some of the logic (e.g gap in the service at around 17:50) can be gathered but there is no detailed explanation.

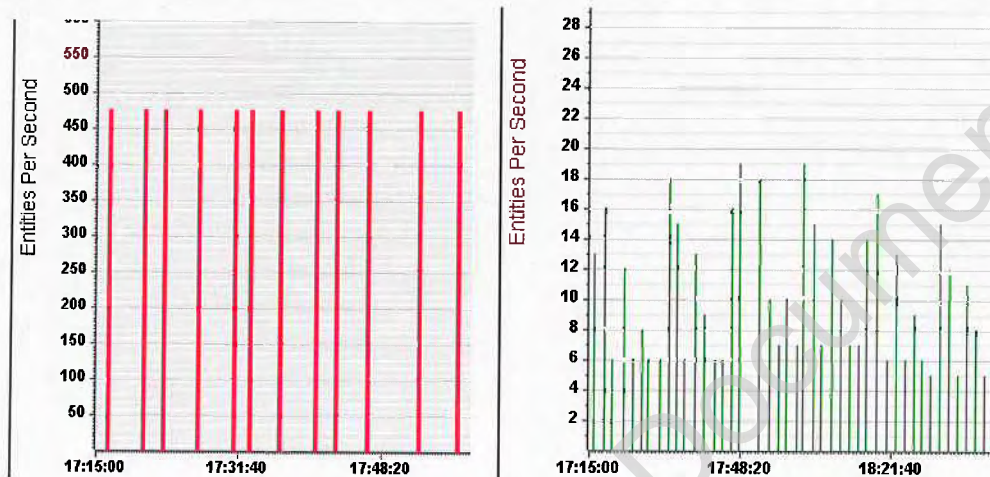

For example:

- Why has a Shenfield service (18TPH) been cancelled over an Abbey Wood service (12 TPH)?
- How can we be sure the most impactful cancelled train has been taken out of the scheduled timetable (see below)?

| | | | |
|-----|----------|-----------------|------------|
| CRL | 17:46:23 | Heathrow | Shenfield |
| CRL | 17:48:13 | Maidenhead | Abbey Wood |
| CRL | 17:50:19 | Paddington | Shenfield |
| CRL | 17:52:24 | West Drayton | Shenfield |
| CRL | 17:54:50 | Paddington | Abbey Wood |
| CRL | 17:56:46 | Paddington | Shenfield |
| CRL | 17:58:16 | Ealing Broadway | Abbey Wood |

LST8: Platform Train Interface logic on the CRL platforms [UNKNOWN]

The way in which passengers immediately head towards the platform edge doors (PEDs) draws parallels with the behaviour currently seen at Canary Wharf in the PM Peak. Are we confident, with more than one destination on CRL services, that passengers even if their train is not first to arrive will always head towards the queue and gather around the doors once they have chosen their preferred carriage on the platform? Would the congestion thematic maps (CMD, CHD plots etc.) that we are generating look significantly different if we modelled the platform train interface logic in a different way (e.g. how it used to be modelled)?

LST9: Pulsing from NR concourse not evident at Ticket Hall B Entrance – appreciated that this is supposed to be a simplification of this area when this was absent before [UNKNOWN]

There is an argument, if the opportunity arises, to add some randomness to the flow coming from Street / NR entrances. For example, some random noise using the parameters [0,3]; at the moment there is an argument that the street/NR demands are too spread out.

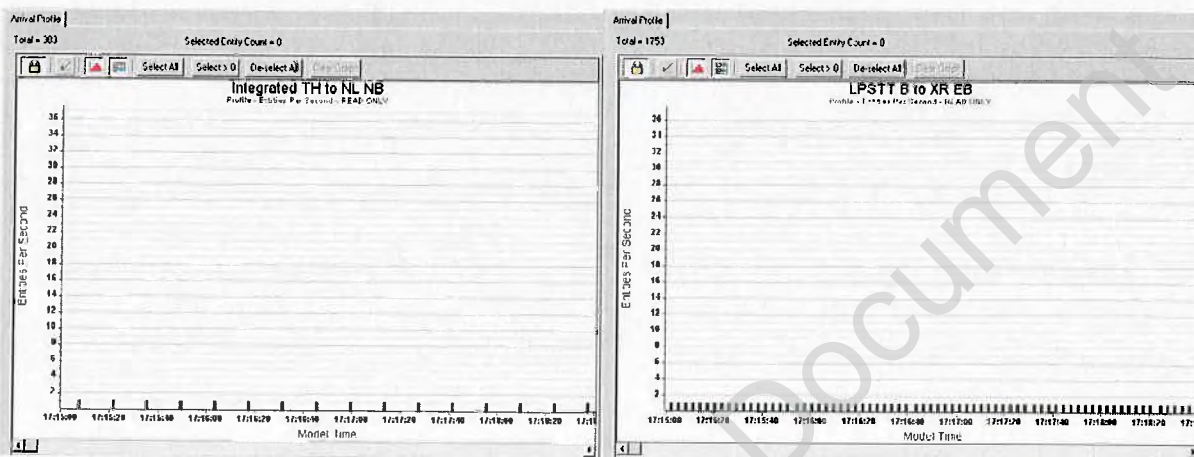

LST10: Model does not run for 3 hours allowing verification against the CPFRv5 Official Demand Matrices difficult [UNKNOWN]

The extent of the model and associated run times has dictated that the model simulation time was trimmed. Although not ideal, having produced an equivalent 1.5 hour CPFRv5 (Revised Forecast) matrix, it was eventually possible to verify that the model output married up closely with the expected demand. The only possible counter argument could be that there should be passengers in the model to begin with (17:15) as oppose to none at all – are we confident the model has built up to a steady and representative state by the time the critical 17:45-18:00 period has come along?

LST11: The ways in which the entity types are set up are not fully in line with Legion Best Practice Guide [UNKNOWN->INSIGNIFICANT]

The entities are not set up solely by destination but instead are set up as a mix of 'by Destination' and 'by Origin and Destination'. The latter increases the complexity of the audit and subsequent modification to the model. Hence, there are inconsistencies over the approach with CRL WB, CRL EB, MET WB, MET EB following best practice and the other platforms set up differently. It is recognised that the current state/extent of the model is in a significantly better state than the model received in May 2009 to audit and that model extensions have been made in the last few months.

Audit Note: Credit for all the accompanying spreadsheets that were delivered with the model files, in particular use of the MOD() function making sure that all alighters are taken care of when dividing a train load by the number of carriages. Very elegant way of doing things, things like this have not gone unnoticed.

- LST12:** Clarity over the Population Zones used to represent PRM Type A passengers [INSIGNIFICANT]
- Clarity over the following Event Profile – 'EP Congestion Relief 1 Passenger' [INSIGNIFICANT]
- Clarity over the following Delay Profiles – 'Boarding' 'Alighting' [INSIGNIFICANT]
- Clarity over the following Event Profiles – 'FCC Plus 3 mins' etc. [INSIGNIFICANT]
- Clarity over the following Event Profiles – 'CRL EB Stop Alighting' [INSIGNIFICANT]

A simple explanation over the purpose of each of the above profiles would be useful to complete understanding of some of the key logic in the model.



Kind Regards

[Redacted signature]

Recipients:

[Redacted recipient name]

CC:

[Redacted recipient name]

[Redacted recipient name]

[Redacted recipient name]

[Redacted recipient name]

Learning Legacy Document



ISSUES LOG - Audit of the Liverpool Street/Moorgate CRL/LU Complex - 2026+28% AM and PM Peak Models

Post Audit Meeting - Tuesday 23rd November 2010 [Mott MacDonald (C138), CRL, London Underground]

| | | SIGNIFICANT | UNKNOWN | INSIGNIFICANT | ACTION |
|-------|--|-------------|---------|---------------|--------|
| LST1 | Boarding profile assumption diagram has been changed in the previously agreed Assumption Cover Sheet to accommodate a new position for 10 car trains but each respective platform entrance profile has stayed the same [SIGNIFICANT] | | | | |
| LST2 | Passengers migrate down the CRL EB platform and do not abide by the boarding logic contained in the Original Assumption Cover Sheets. This migration paints the best picture of this platform but is not guaranteed to hold true in reality [SIGNIFICANT] | | | | |
| LST3 | Lift Logic in places (e.g. Moorgate Integrated Ticket Hall) appears not to follow the recommendations in the LU Legion Best Practice Guide [SIGNIFICANT] | | | | |
| LST4 | Escalator Configurations and associated logic around the Northern Line TH in the PM Peak model [SIGNIFICANT] | | | | |
| LST5 | UTS Gatetime throughput assumed in the 2026 +28% AM Peak Models [UNKNOWN] | | | | |
| LST6 | Further explanation over the justification for No Cancelled Train being present in the AM Peak models [UNKNOWN] | | | | |
| LST7 | Cancelled train logic is evident but only partially captured by interrogating model [UNKNOWN] | | | | |
| LST8 | Platform Train Interface logic on the CRL platforms [UNKNOWN] | | | | |
| LST9 | Pulsing from NR concourse not evident at Ticket Hall B Entrance - appreciated that this is supposed to be a simplification of this area when this was absent before [UNKNOWN] | | | | |
| LST10 | Model does not run for 3 hours allowing verification against the CFRv5 Official Demand Matrices difficult [UNKNOWN] | | | | |
| LST11 | The ways in which the entity types are set up are not fully in line with Legion Best Practice Guide [UNKNOWN-INSIGNIFICANT] | | | | |
| LST12 | Clarity over the Population Zones used to represent PRIM Type A passengers [INSIGNIFICANT] Clarity over the following Event Profile - 'EP Congestion Relief 1 Passenger' [INSIGNIFICANT] Clarity over the following Delay Profiles - 'Boarding' 'Alighting' [INSIGNIFICANT] Clarity over the following Event Profiles - 'FCC Plus 3 mins' etc. [INSIGNIFICANT] Clarity over the following Event Profiles - 'CRL EB Stop Alighting' [INSIGNIFICANT] | | | | |



Appendix D: Dynamic Passenger Modelling Output – RIBA E

Learning Legacy Document



C138: Liverpool Street Station Dynamic Passenger Modelling Output – RIBA E

Model Layout

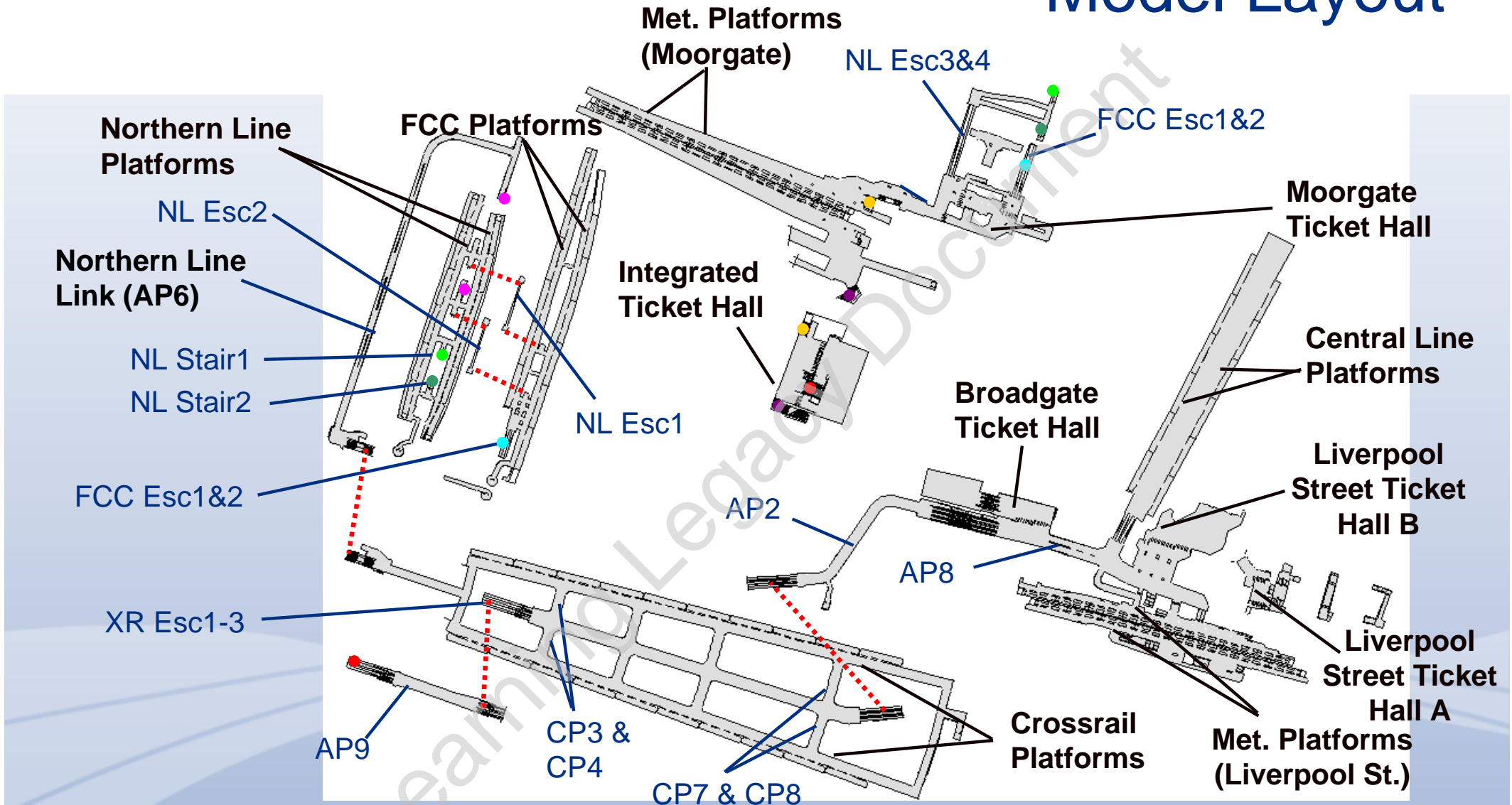

Link between vertical transportation or ● or ● or ● or ●

Operational Configuration of the Station

Learning Legacy Document

Operational Configuration: Integrated Moorgate Ticket Hall

AM

PM

Stairs to
Met EB

Escalators to
Crossrail platforms

Stairs to
Met WB

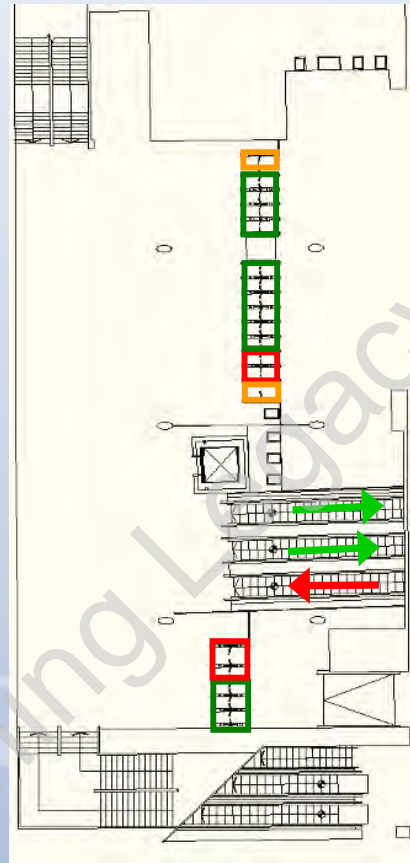
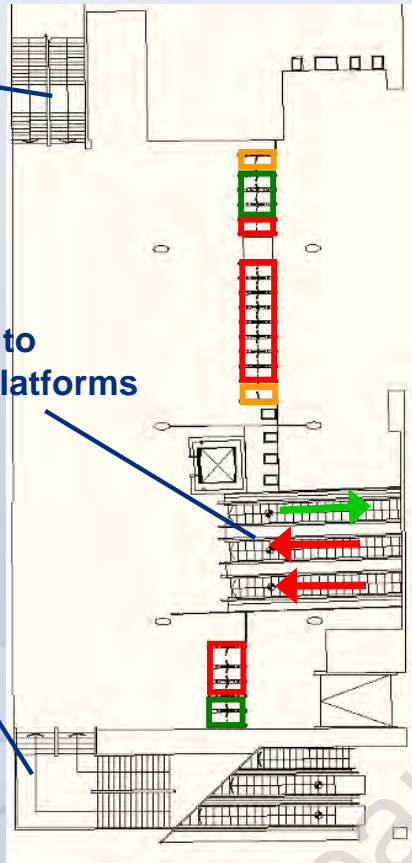

Exit 

Entry 

Wide Access Gate 

Escalator travel direction  Down  Up

| Peak Period | Gate-line | Entry | Exit | WAG |
|-------------|-----------|-------|------|-----|
| AM | Northern | 3 | 9 | 2 |
| | Southern | 2 | 3 | 0 |
| PM | Northern | 10 | 2 | 2 |
| | Southern | 3 | 2 | 0 |

Operational Configuration: Crossrail Platforms

AM

PM

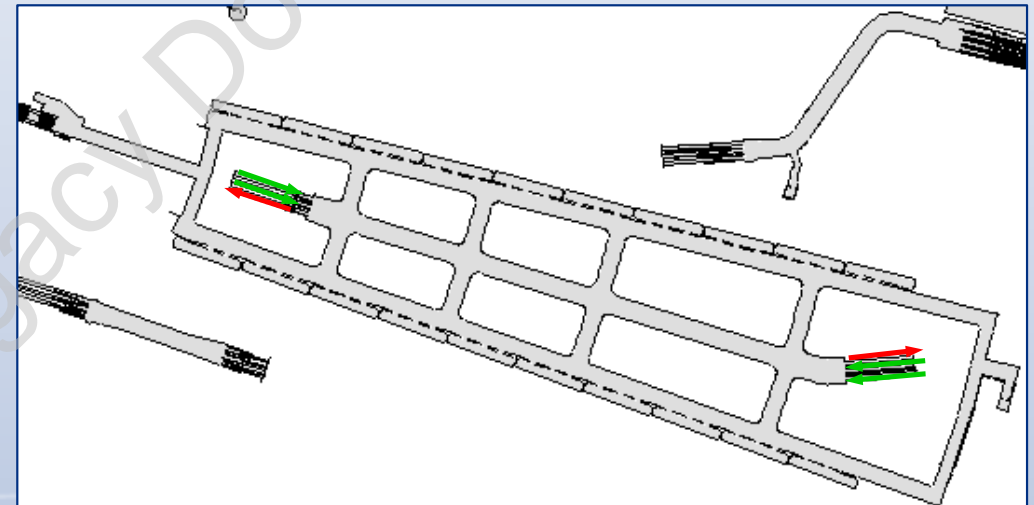
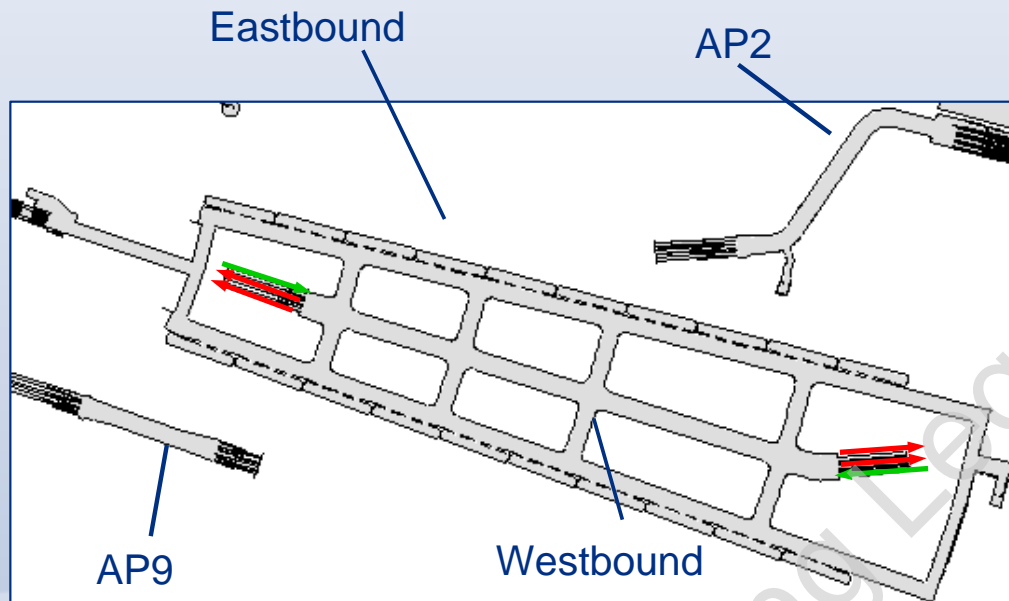

Escalator travel direction ↓ Down ↑ Up

Operational Configuration: Northern Line Link, Northern Line and FCC Platforms

AM

PM

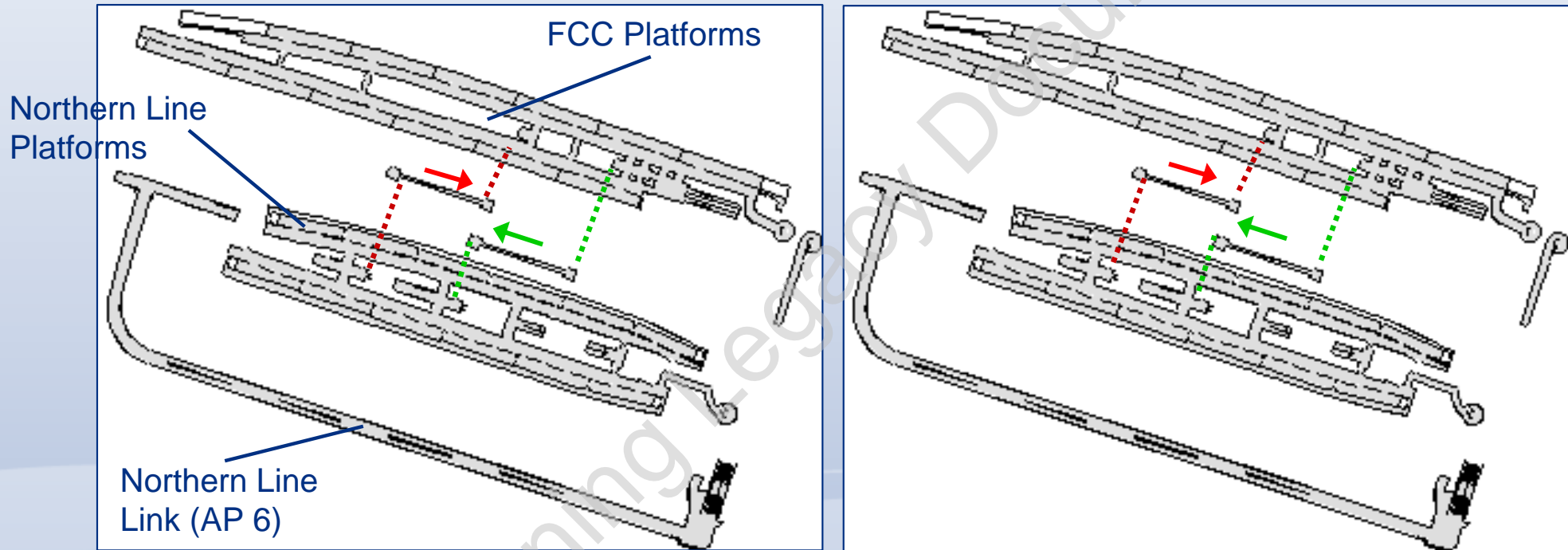

Escalator travel direction ↓ Down ↑ Up

Operational Configuration: Moorgate Ticket Hall

AM Peak

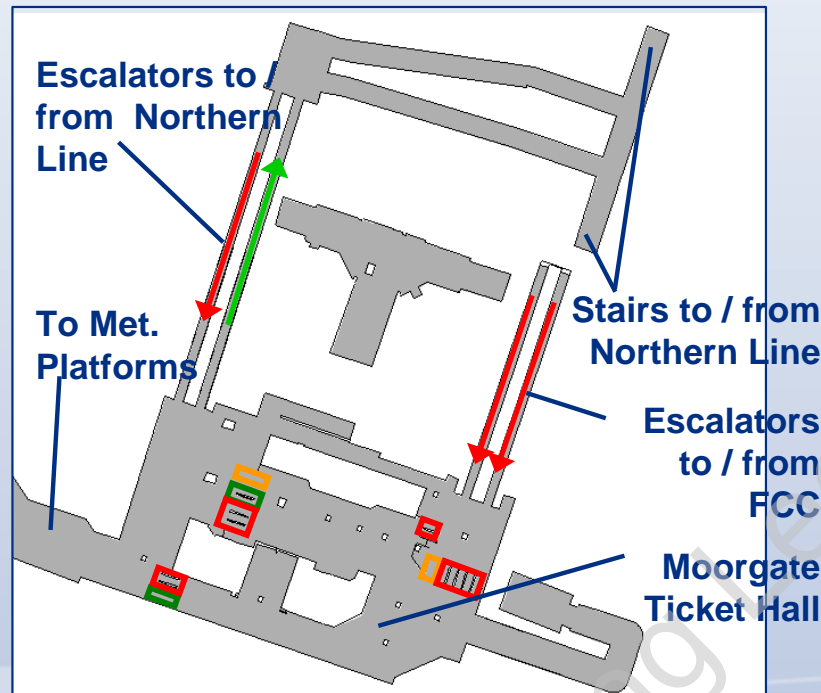

| | Entry | Exit | Bi-Directional |
|-------|-------|------|----------------|
| Gates | 3 | 12 | - |
| WAG | - | 1 | 1 |

PM Peak

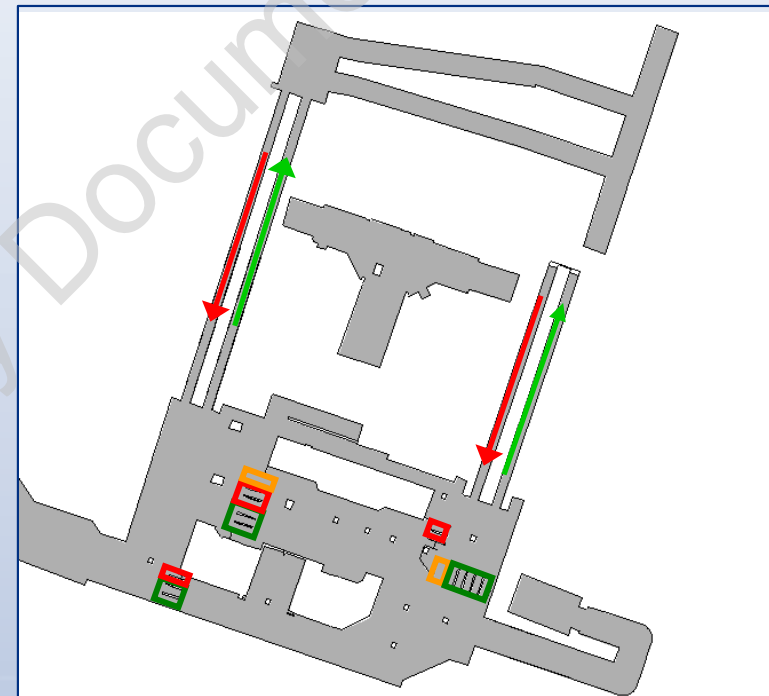

| | Entry | Exit | Bi-Directional |
|-------|-------|------|----------------|
| Gates | 10 | 5 | - |
| WAG | - | - | 2 |

Exit  Entry  Wide Access Gate 

Escalator travel direction  Down  Up

Operational Configuration: Broadgate Ticket Hall

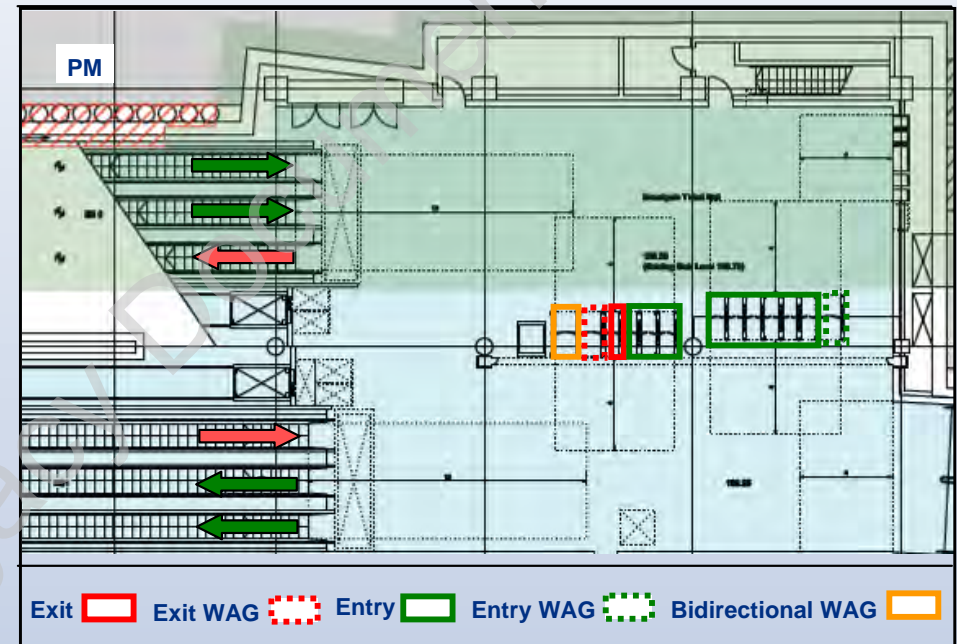
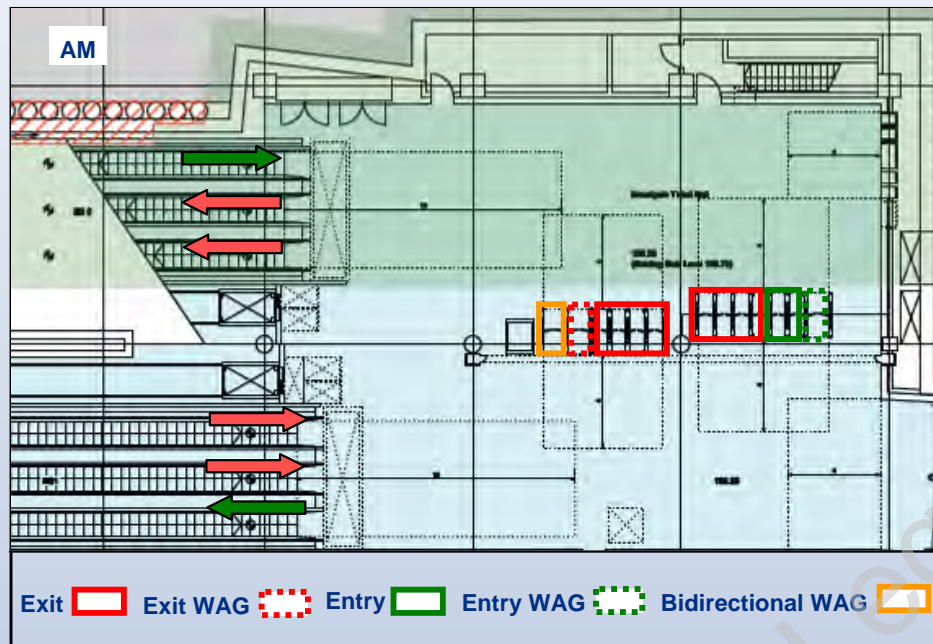

| Number of Gates | Entry | Entry WAG (1-way) | Exit | Exit WAG (1-way) | Bidirectional WAG | Total |
|-----------------|-------|-------------------|------|------------------|-------------------|-------|
| AM | 2 | 1 | 8 | 1 | 1 | 13 |
| PM | 9 | 1 | 1 | 1 | 1 | 13 |

Summary of AM and PM operational configurations

Operational Configuration: Liverpool Street Ticket Hall B

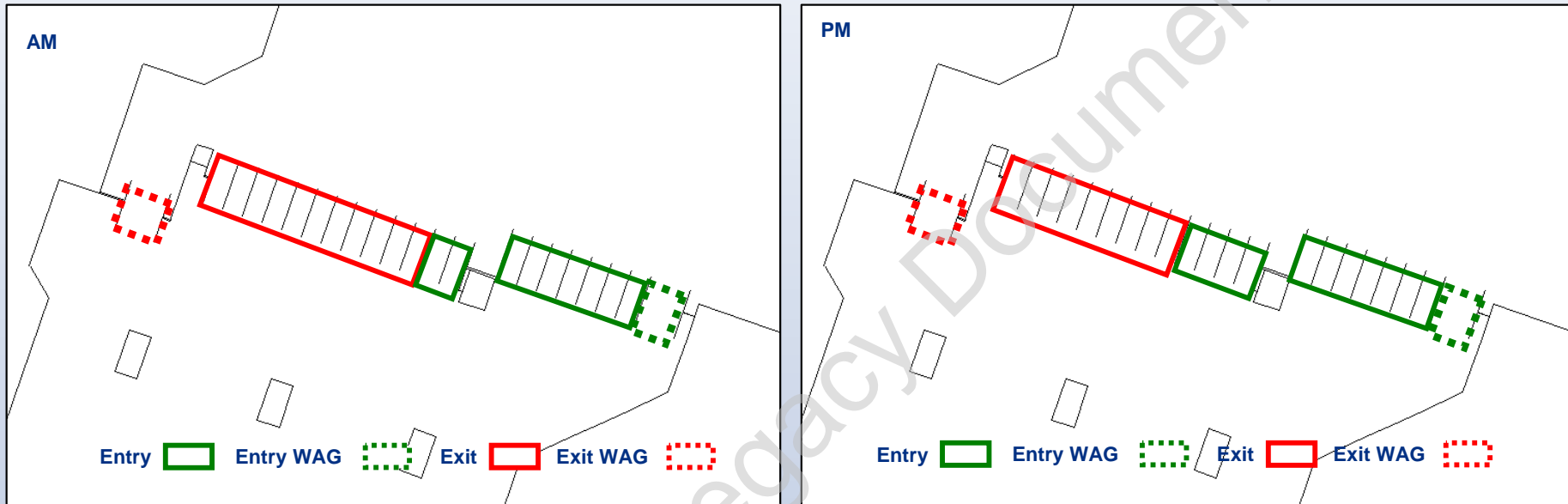

| Number of Gates | Entry Gates | Entry WAG | Exit Gates | Exit WAG | Total Gates |
|-----------------|-------------|-----------|------------|----------|-------------|
| AM | 9 | 1 | 11 | 1 | 22 * |
| PM | 11 | 1 | 9 | 1 | 22 * |

Summary of AM and PM operational configurations

* Updated as part of Crossrail enabling works (22 gates is only after Crossrail increase gateline capacity after enabling works)

Results

Learning Legacy Document

AM – Scenario

Integrated Moorgate Ticket Hall

Integrated Moorgate Ticket Hall

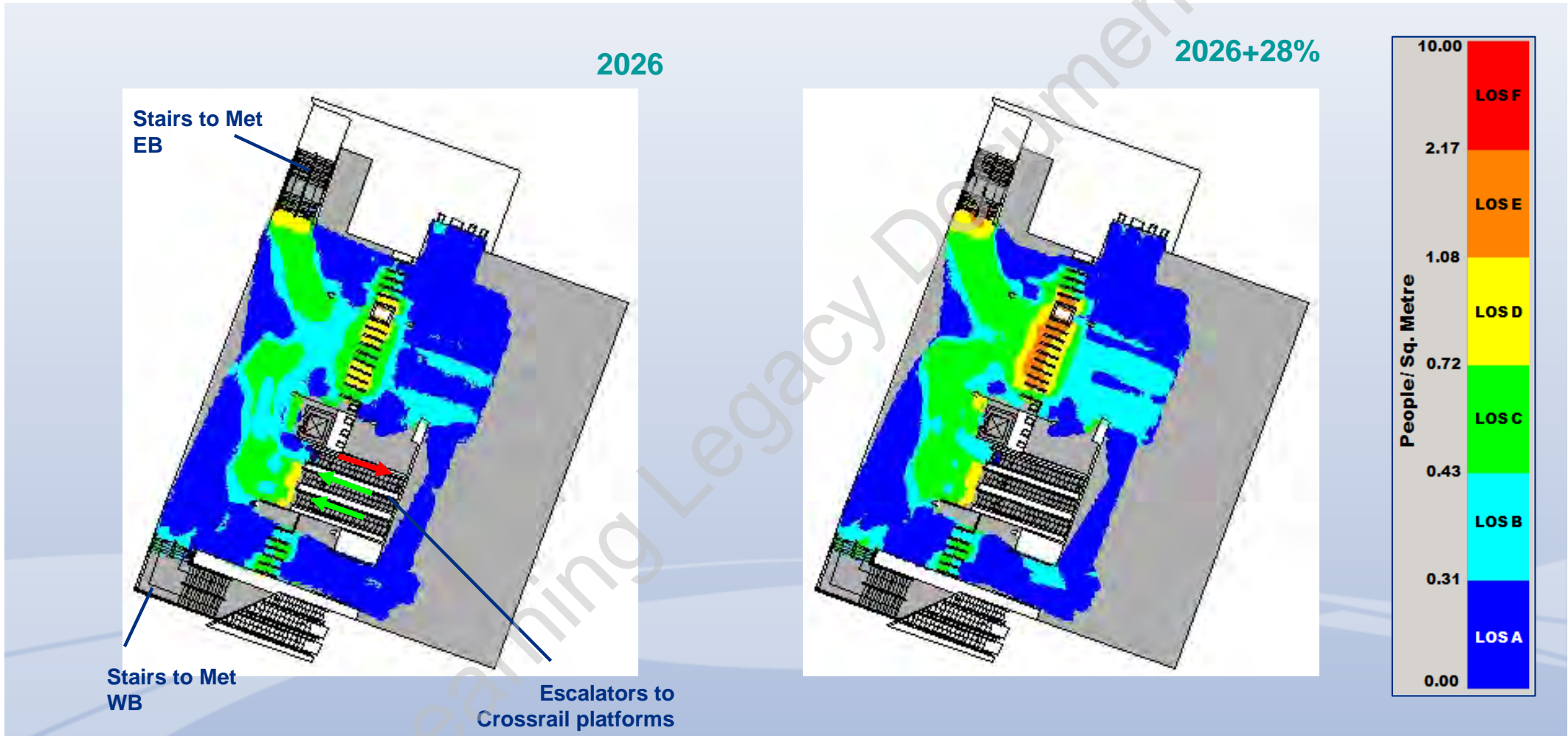

CMD - Walkway LOS (08:45-09:00)

Escalator travel direction ↓ Down ↑ Up

Integrated Moorgate Ticket Hall

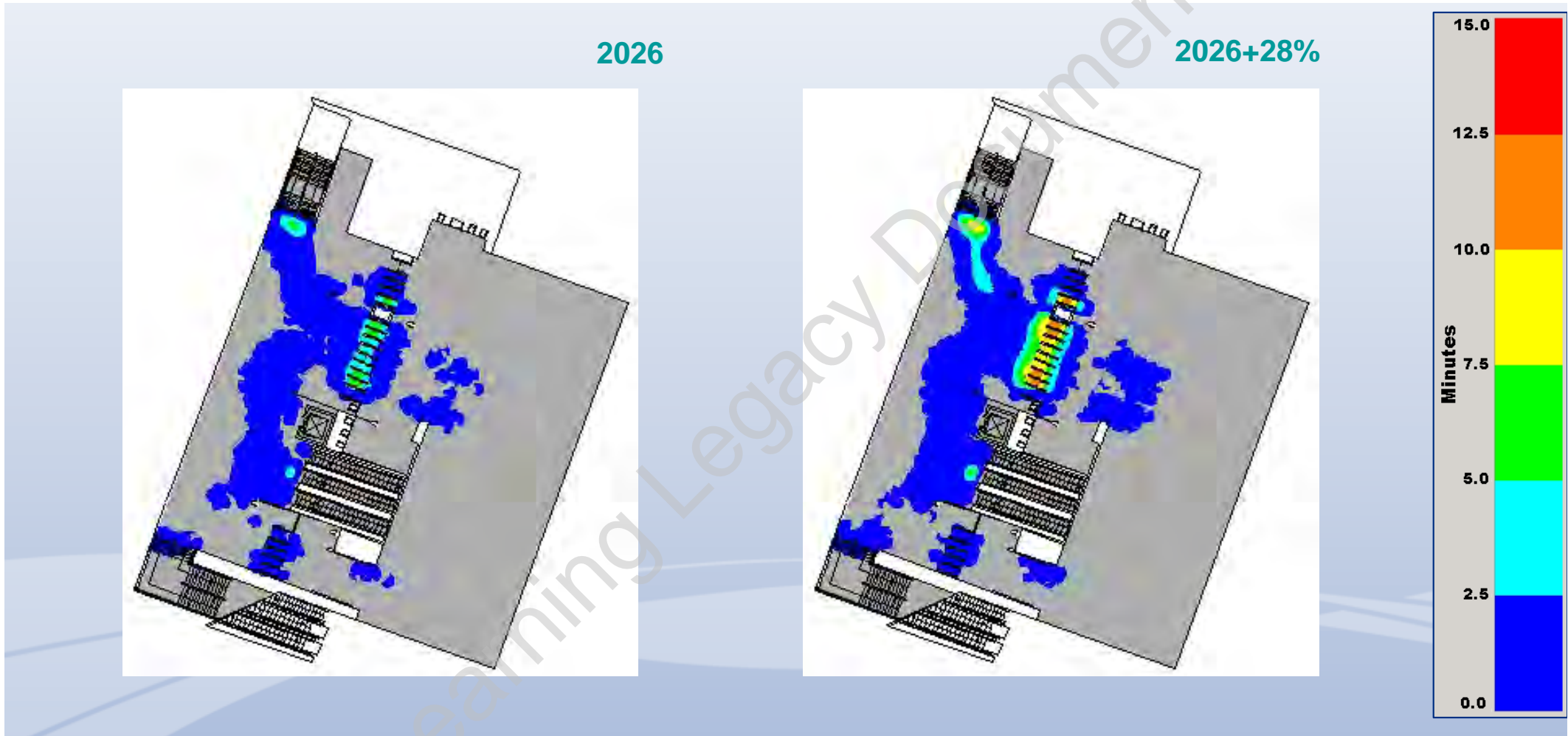

CHD - greater than Walkway LOS C (08:45-09:00)

Integrated Moorgate Ticket Hall

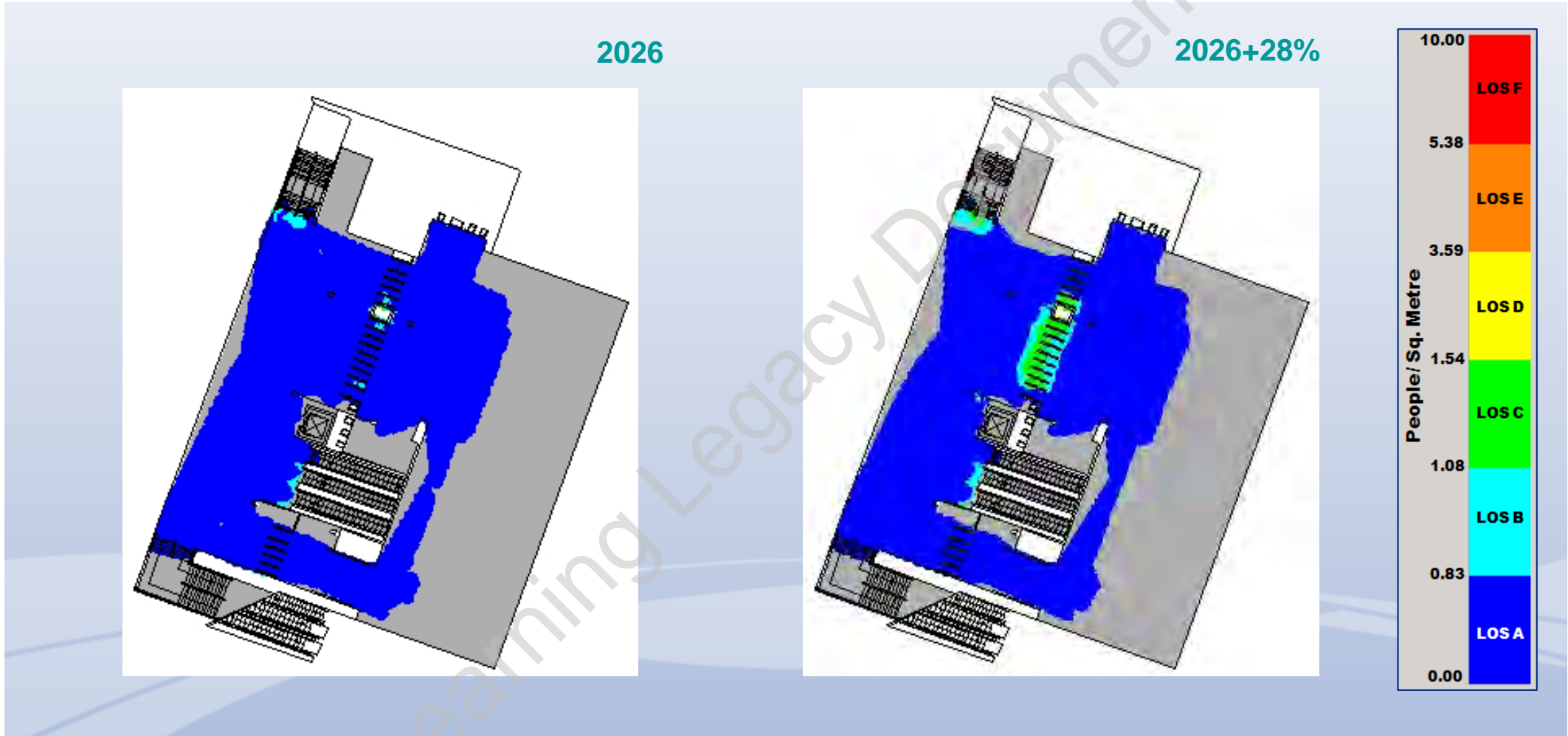

CMD - Queuing LOS (08:45-09:00)

Integrated Moorgate Ticket Hall

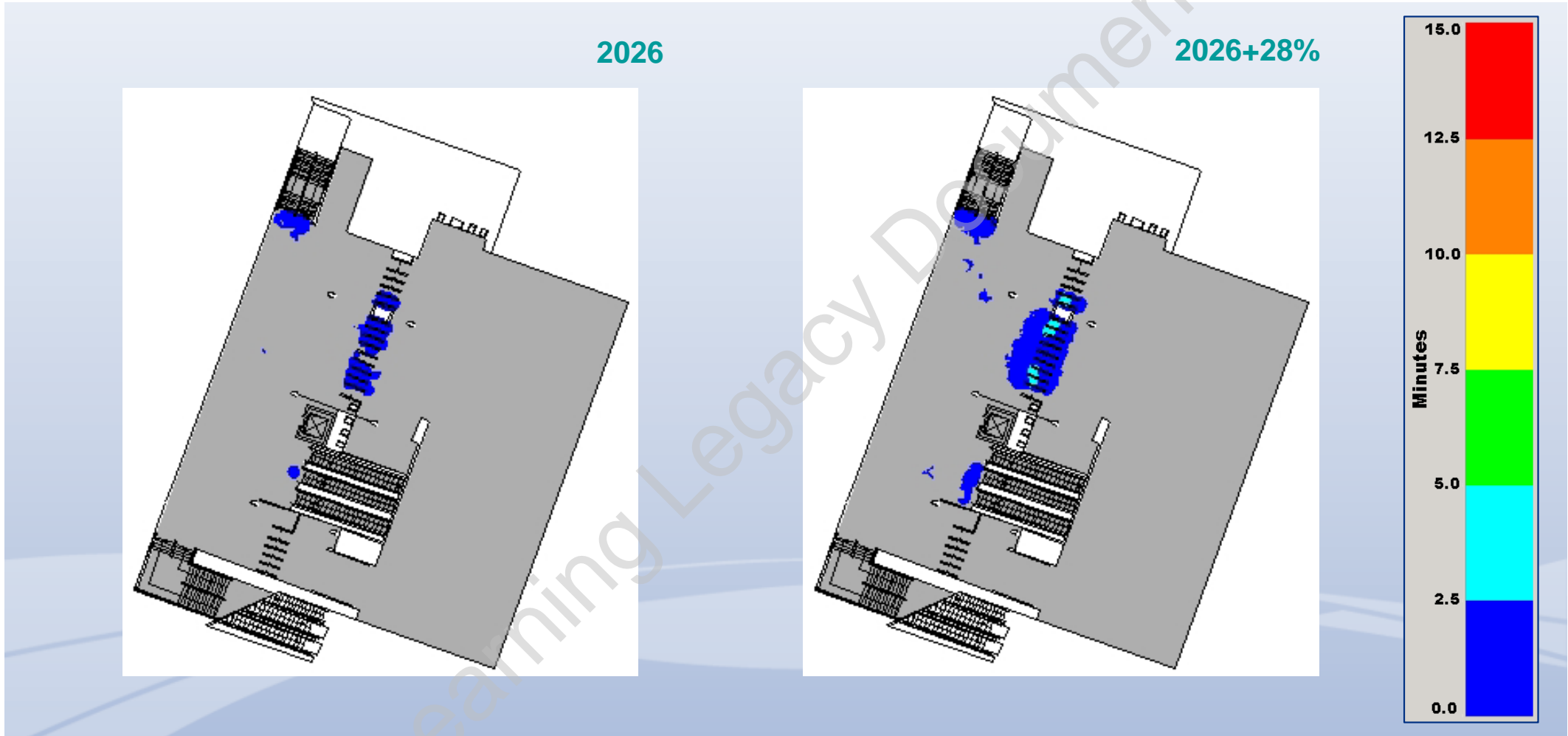

CHD - greater than Queuing LOS C (08:45-09:00)

AM – Scenario

Northern Line Link (NLL), and existing Northern Line and FCC Platforms

NLL, Northern Line and the FCC Platforms

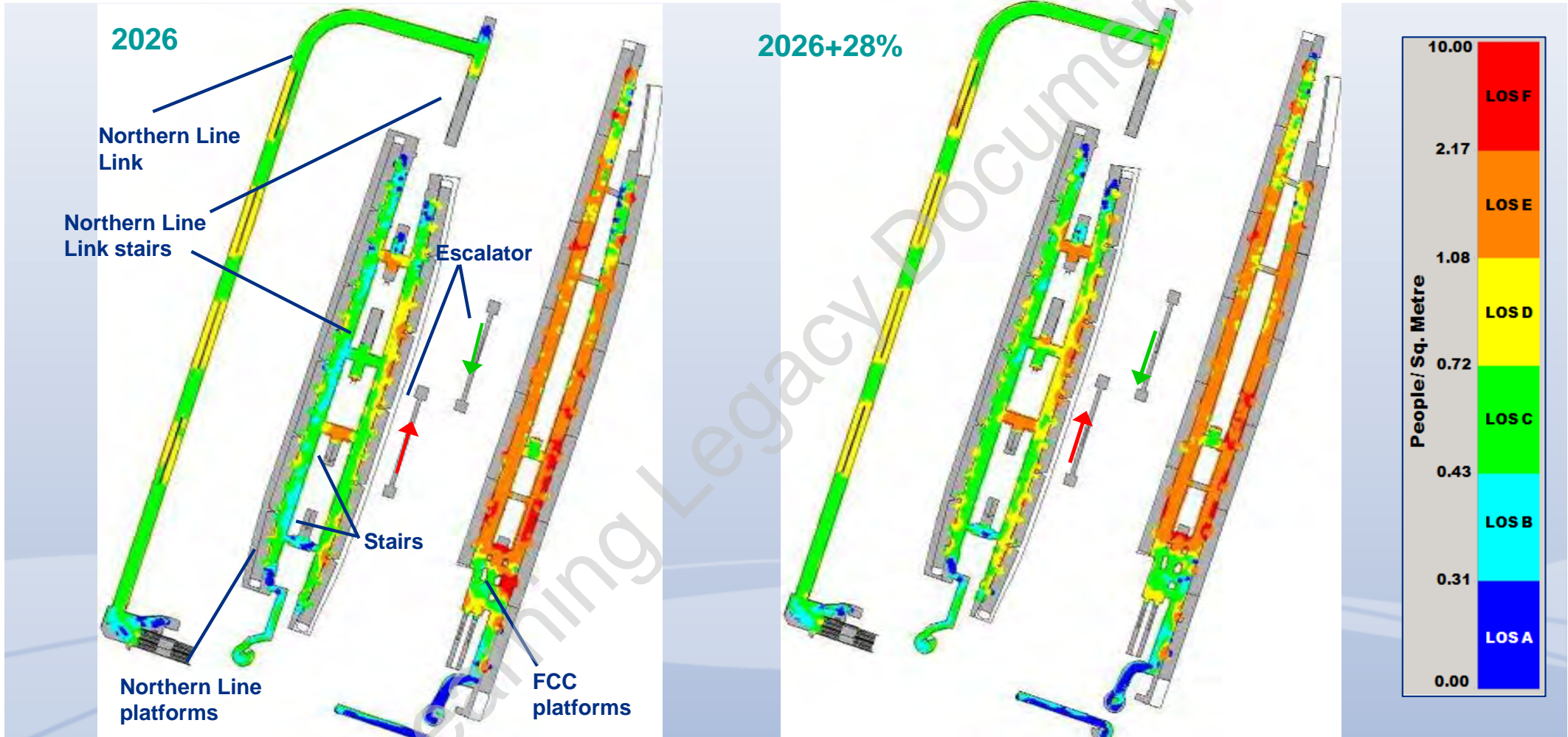

CMD - Walkway LOS (08:45-09:00)

Escalator travel direction ↓ Down ↑ Up

NLL, Northern Line and the FCC Platforms

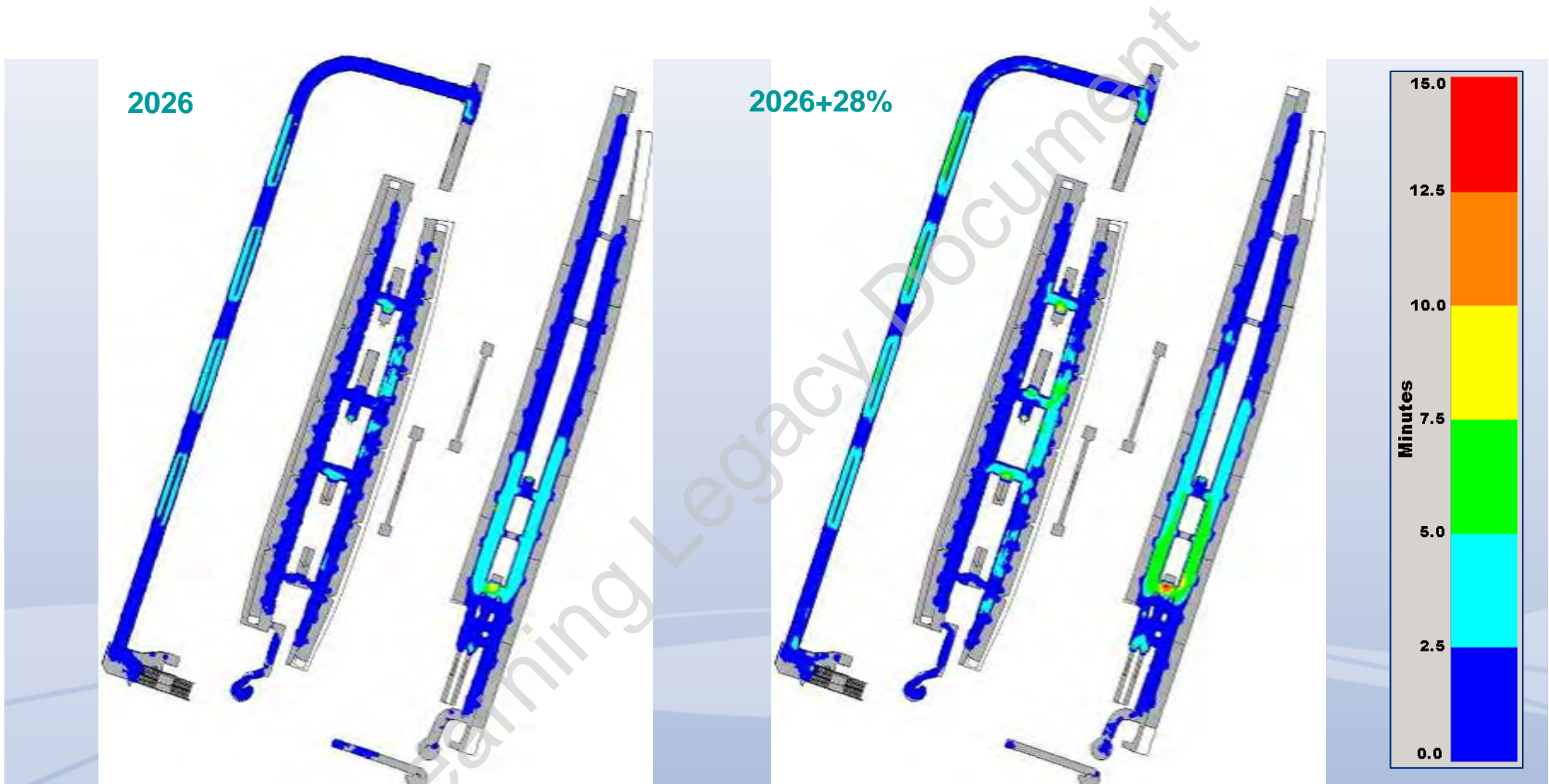

CHD - greater than Walkway LOS C (08:45-09:00)

NLL, Northern Line and the FCC Platforms

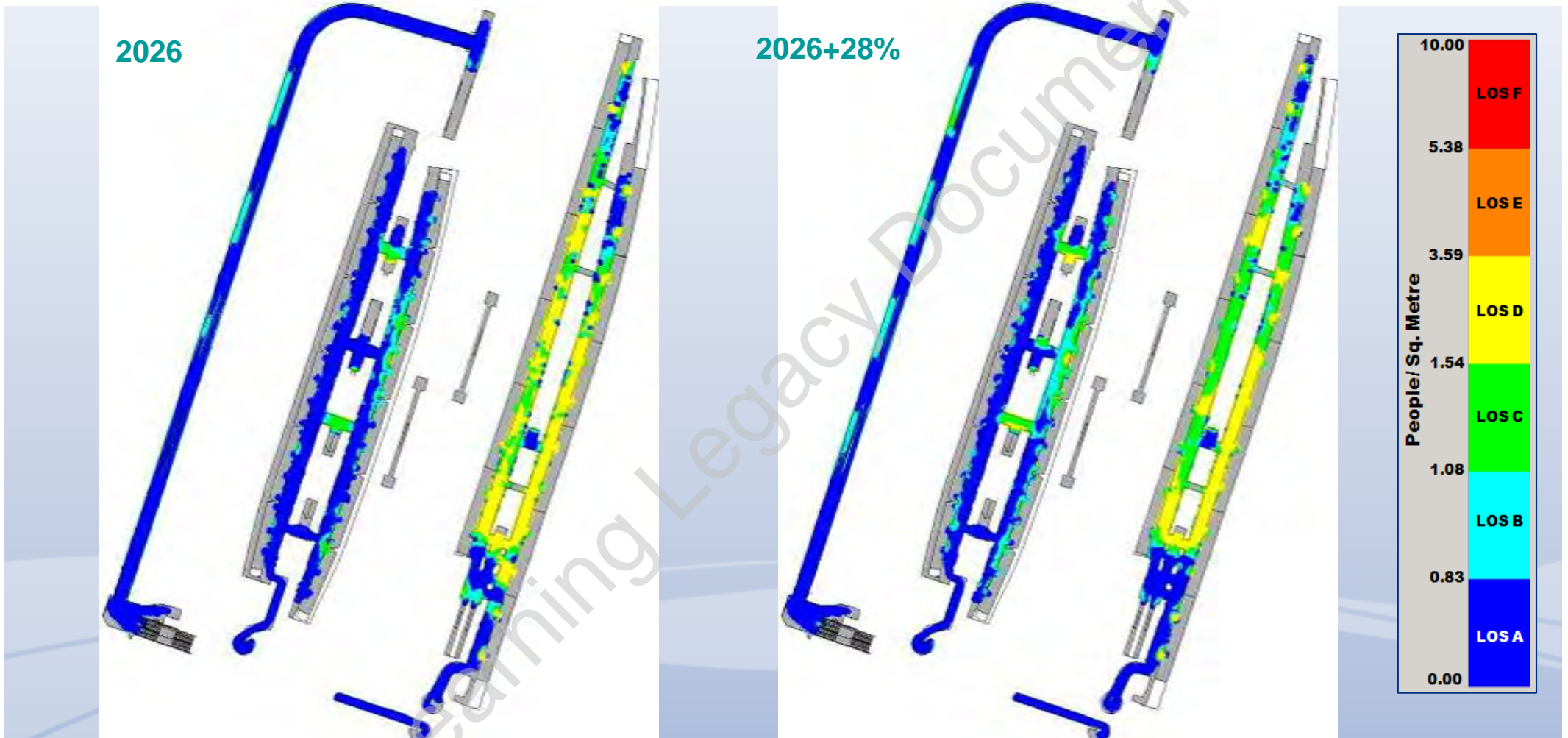

CMD - Queuing LOS (08:45-09:00)

NLL, Northern Line and the FCC Platforms

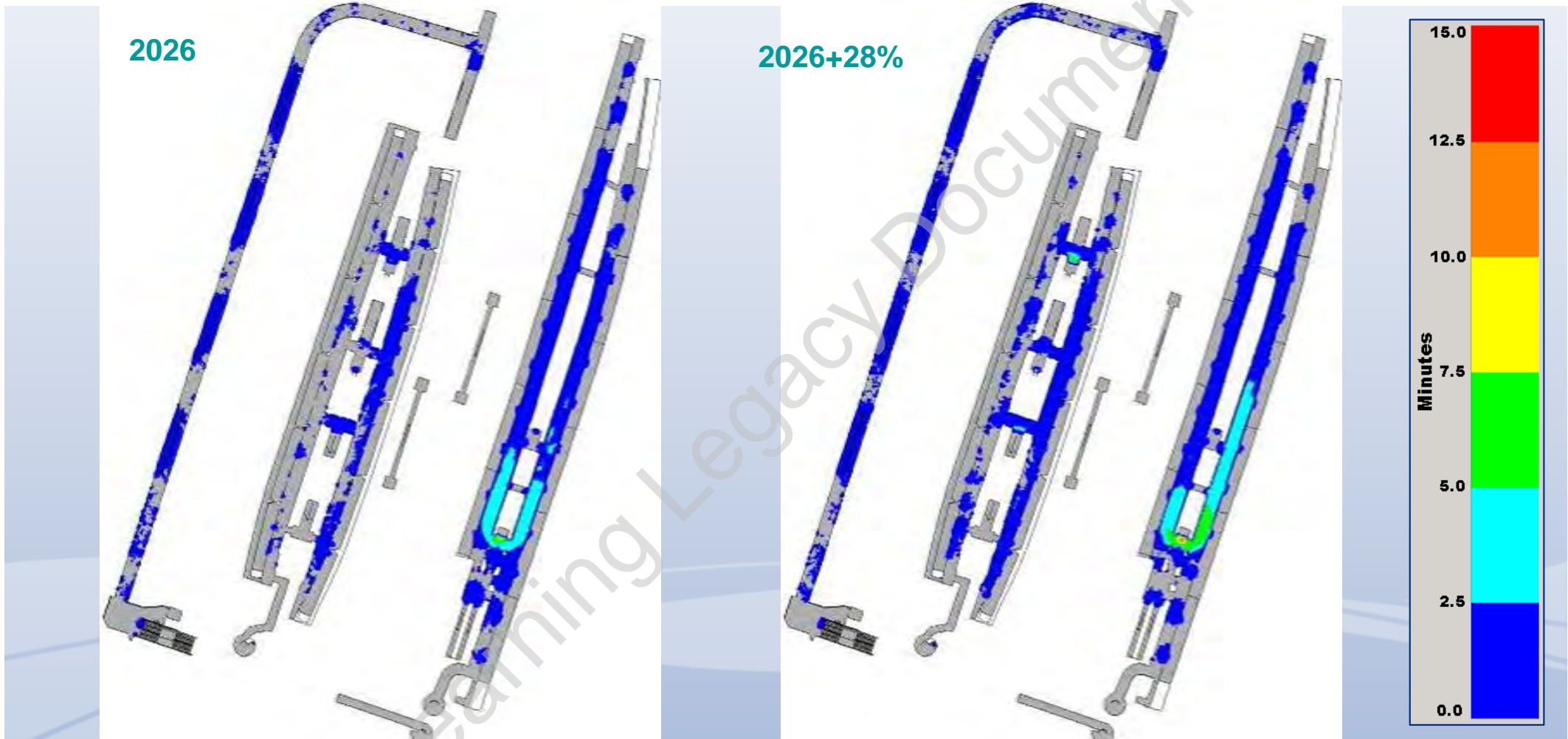

CHD - greater than Queuing LOS C (08:45-09:00)

NLL, Northern Line and the FCC Platforms

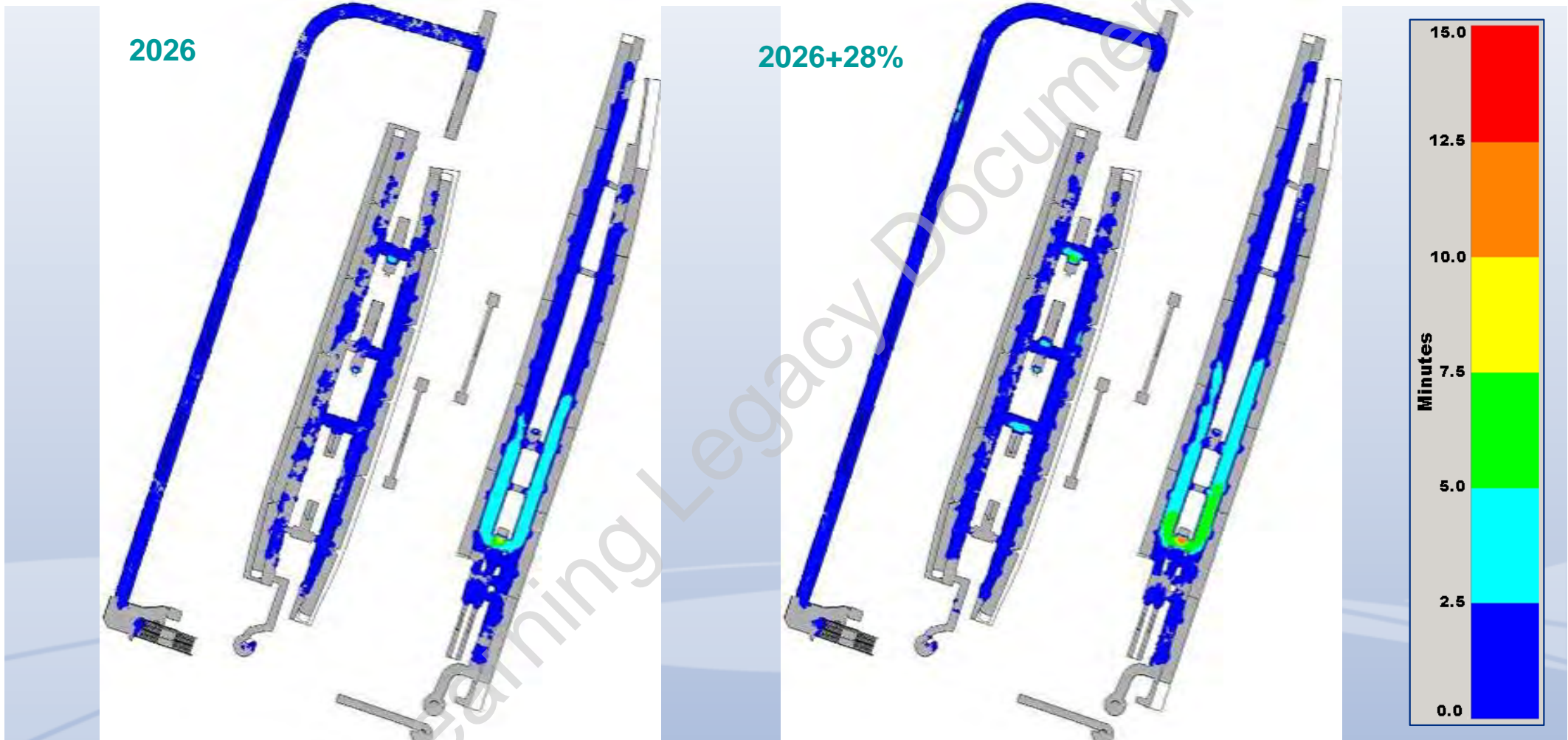

CHD - greater than 1.25 people/Sq. metre (LU Standard) (08:45-09:00)

AM – Scenario

Existing Moorgate Ticket Hall

Existing Moorgate Ticket Hall

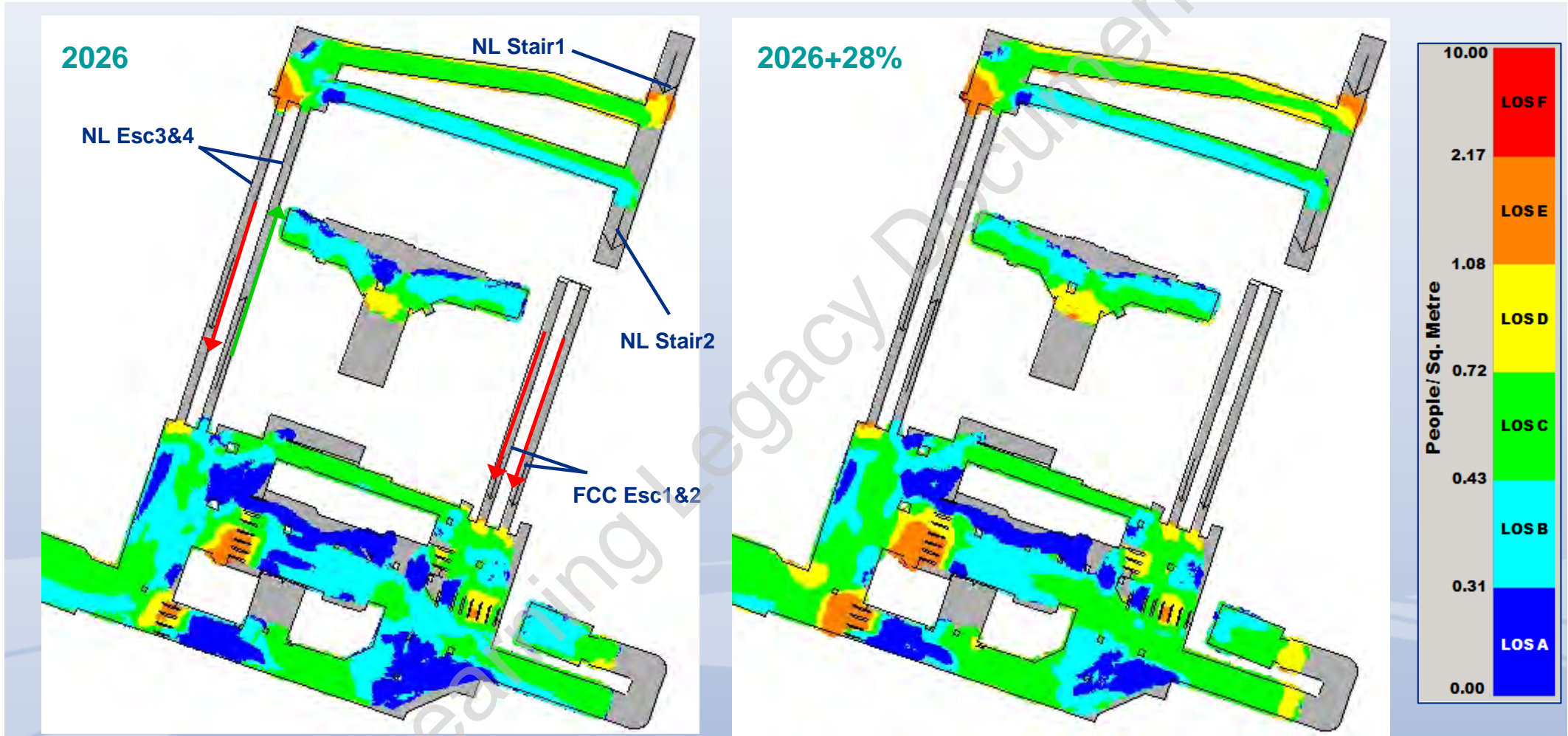

CMD - Walkway LOS (08:45-09:00)

Escalator travel direction ↓ Down ↑ Up

Existing Moorgate Ticket Hall

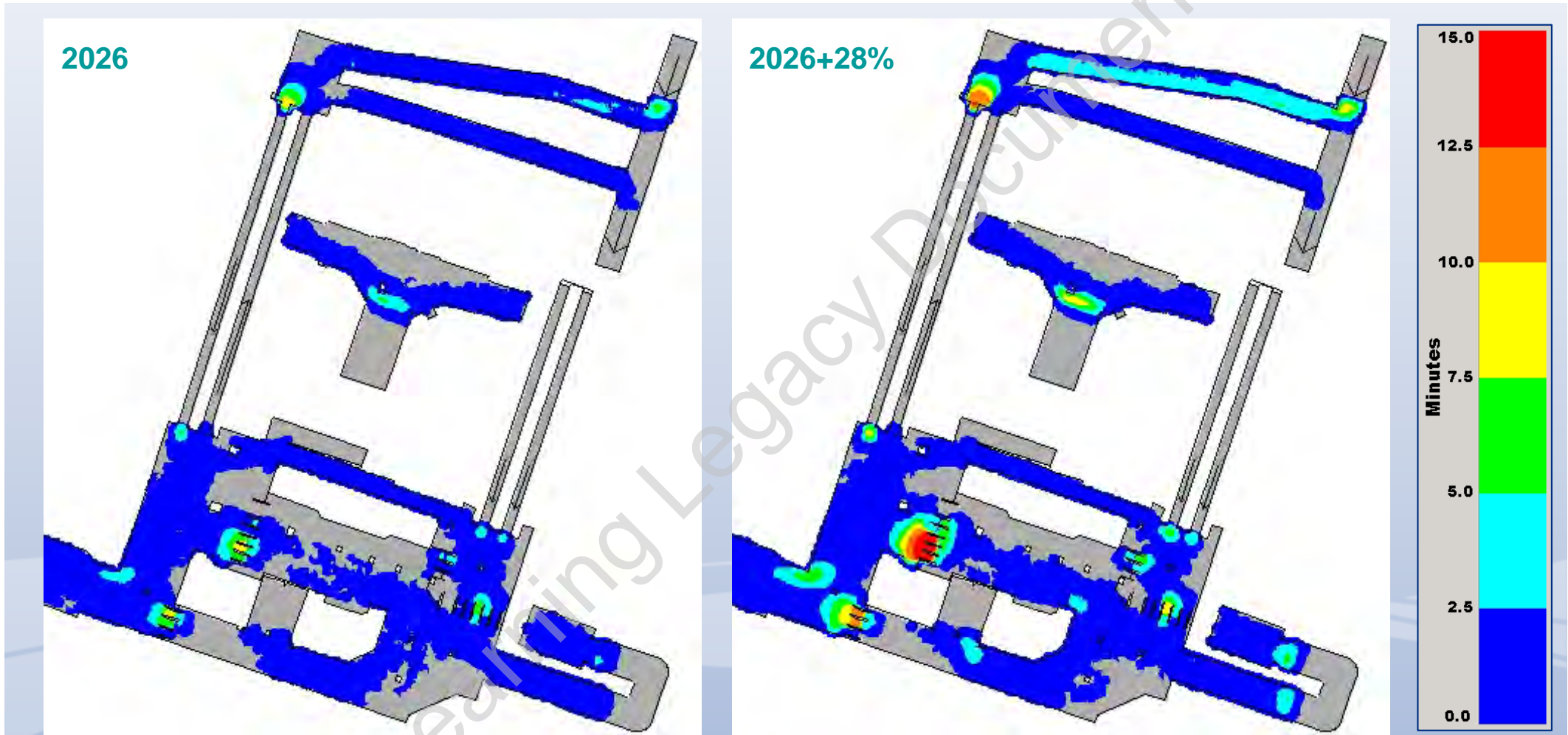

CHD - greater than Walkway LOS C (08:45-09:00)

Existing Moorgate Ticket Hall

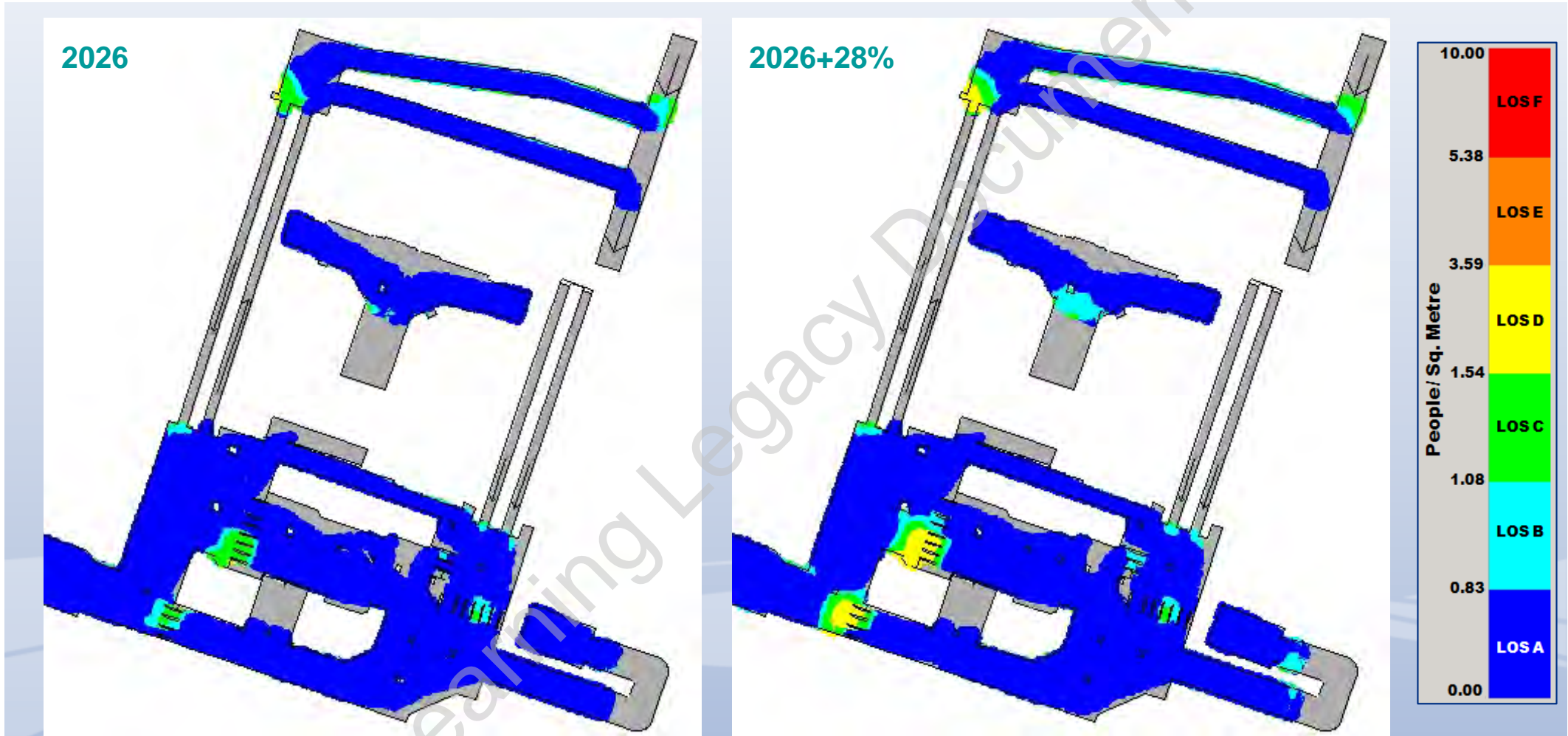

CMD - Queuing LOS (08:45-09:00)

Existing Moorgate Ticket Hall

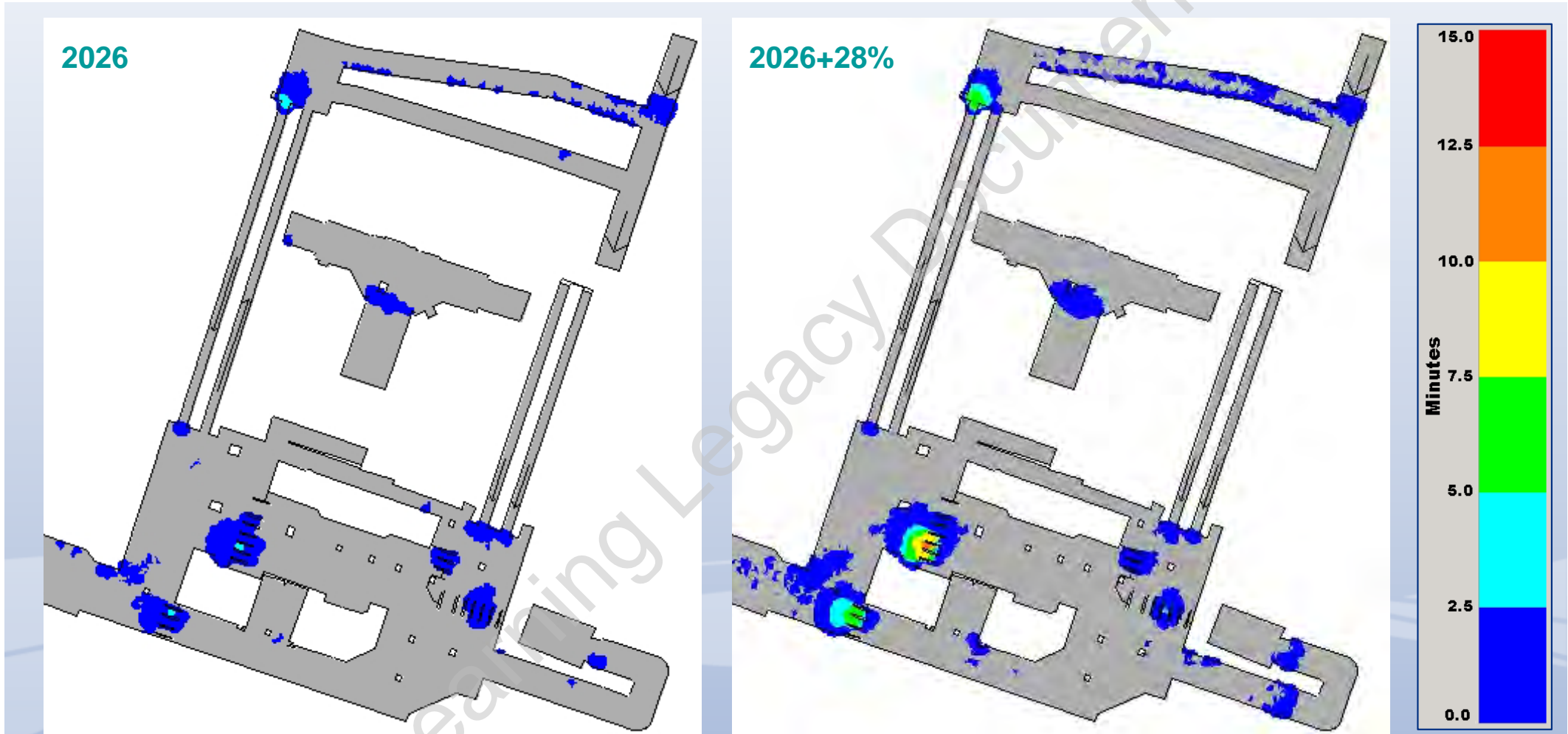

CHD - greater than Queuing LOS C (08:45-09:00)

AM – Scenario

Crossrail Platforms and Passageways AP2 and AP9

Crossrail Platforms and Passageways AP2 and AP9

- In relation to the Crossrail platforms only, Legion modelling output will be shown for the following peak 15 minute periods:
 - 08:30 – 08:45
 - 08:45 – 09:00
 - 09:00 – 09:15

Crossrail Platforms and Passageways AP2 and AP9: Without Cancelled train

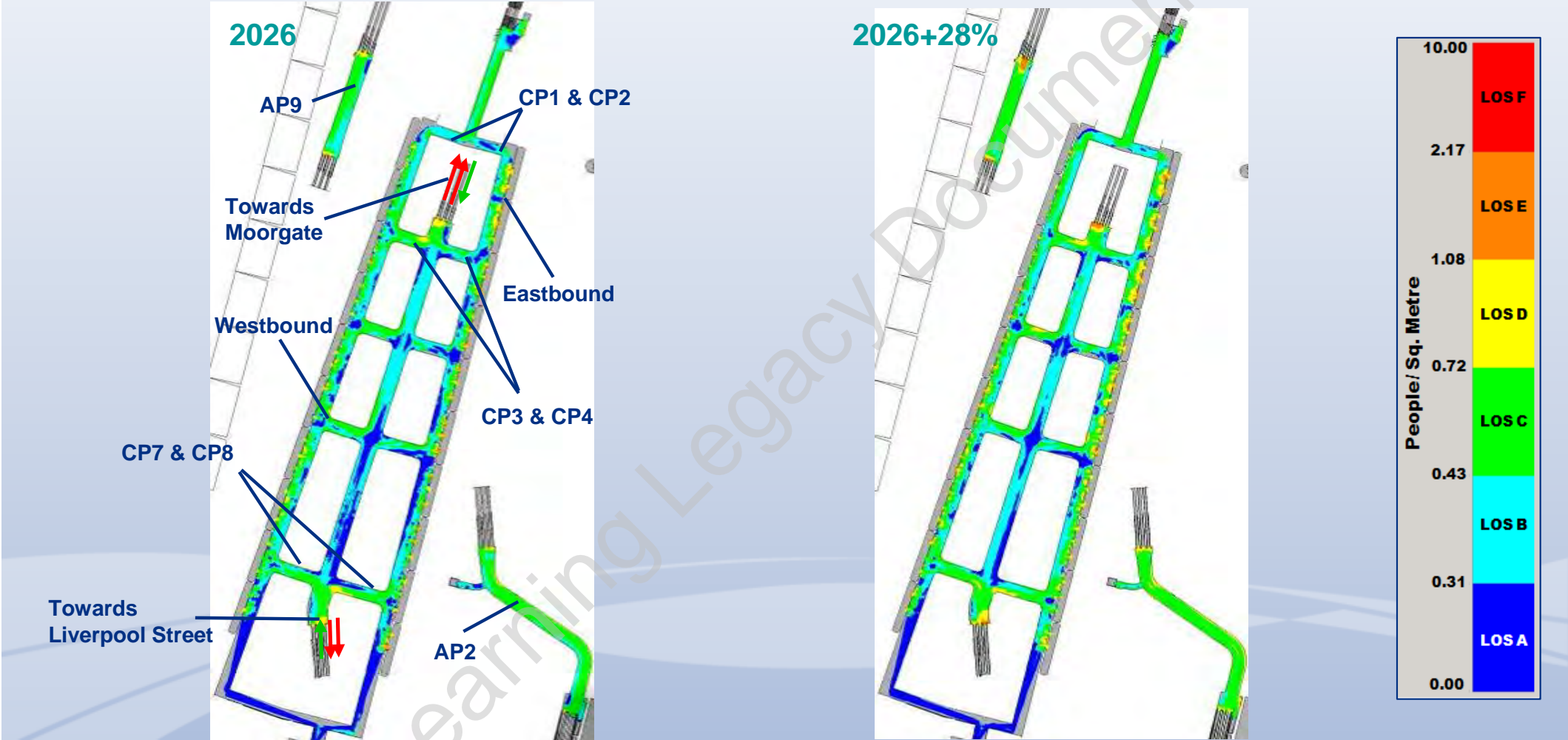

CMD - Walkway LOS (08:30-08:45)

Crossrail Platforms and Passageways AP2 and AP9: Without Cancelled train

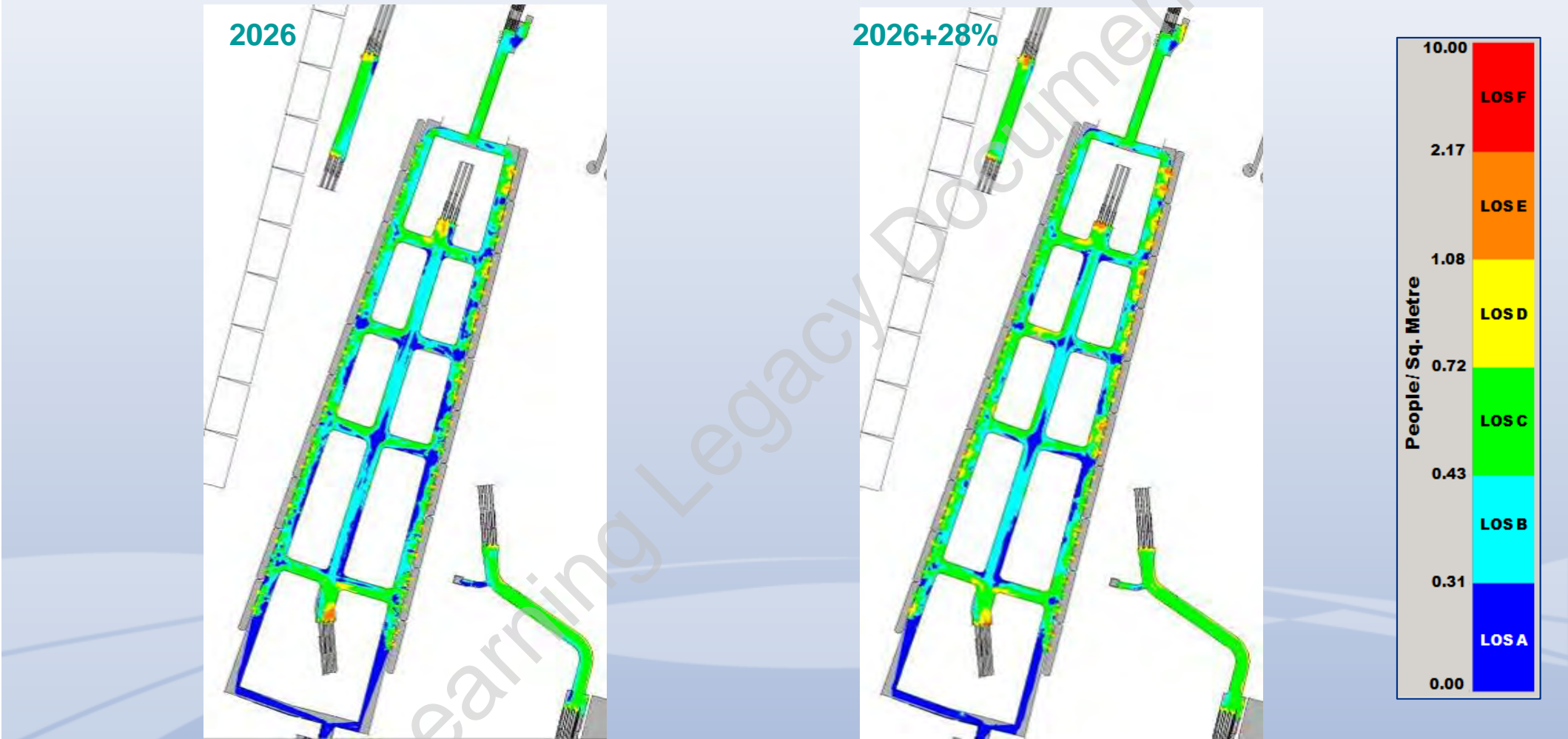

CMD - Walkway LOS (08:45-09:00)

Escalator travel direction ↓ Down ↑ Up

Crossrail Platforms and Passageways AP2 and AP9: Without Cancelled train

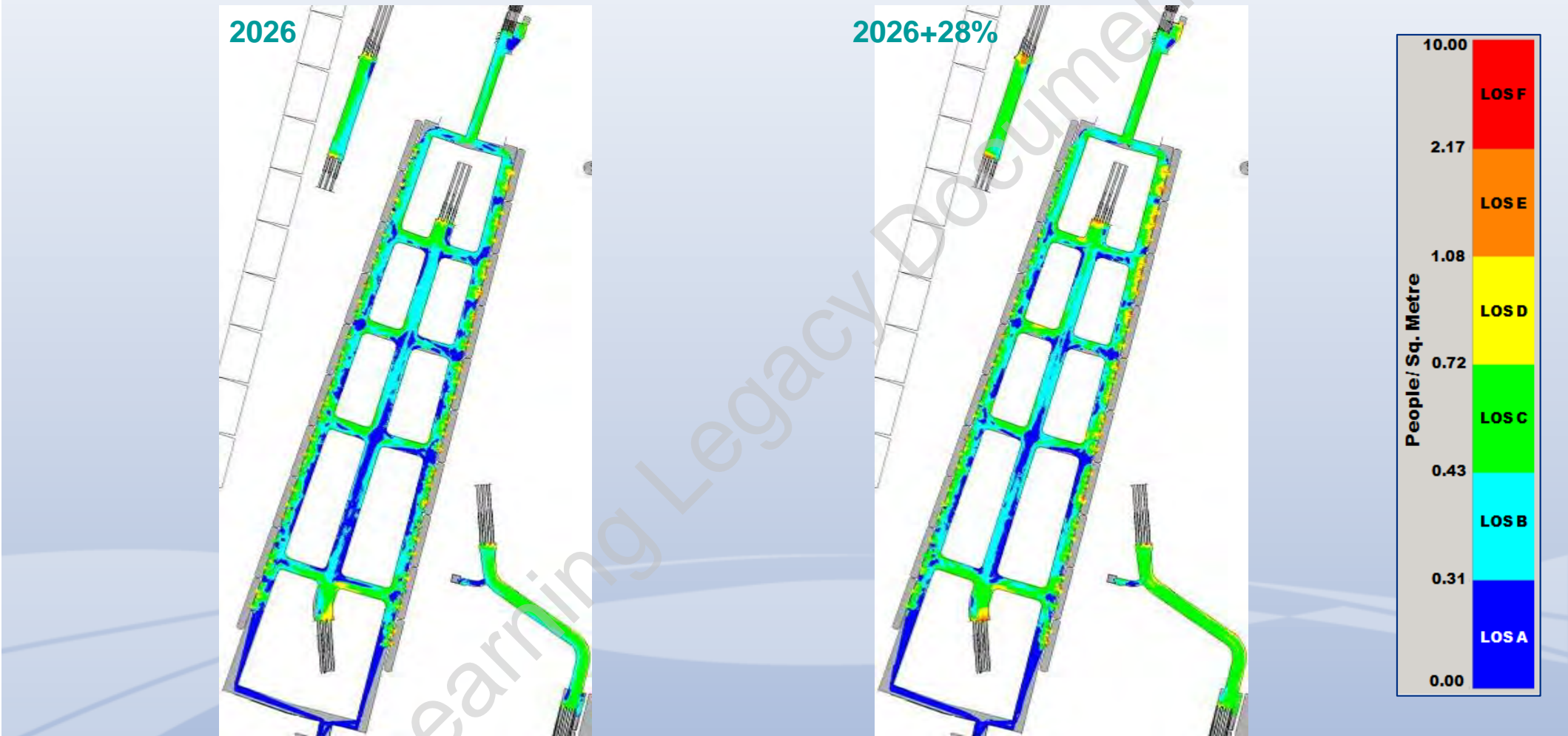

CMD - Walkway LOS (09:00-09:15)

Crossrail Platforms and Passageways AP2 and AP9: Without Cancelled train

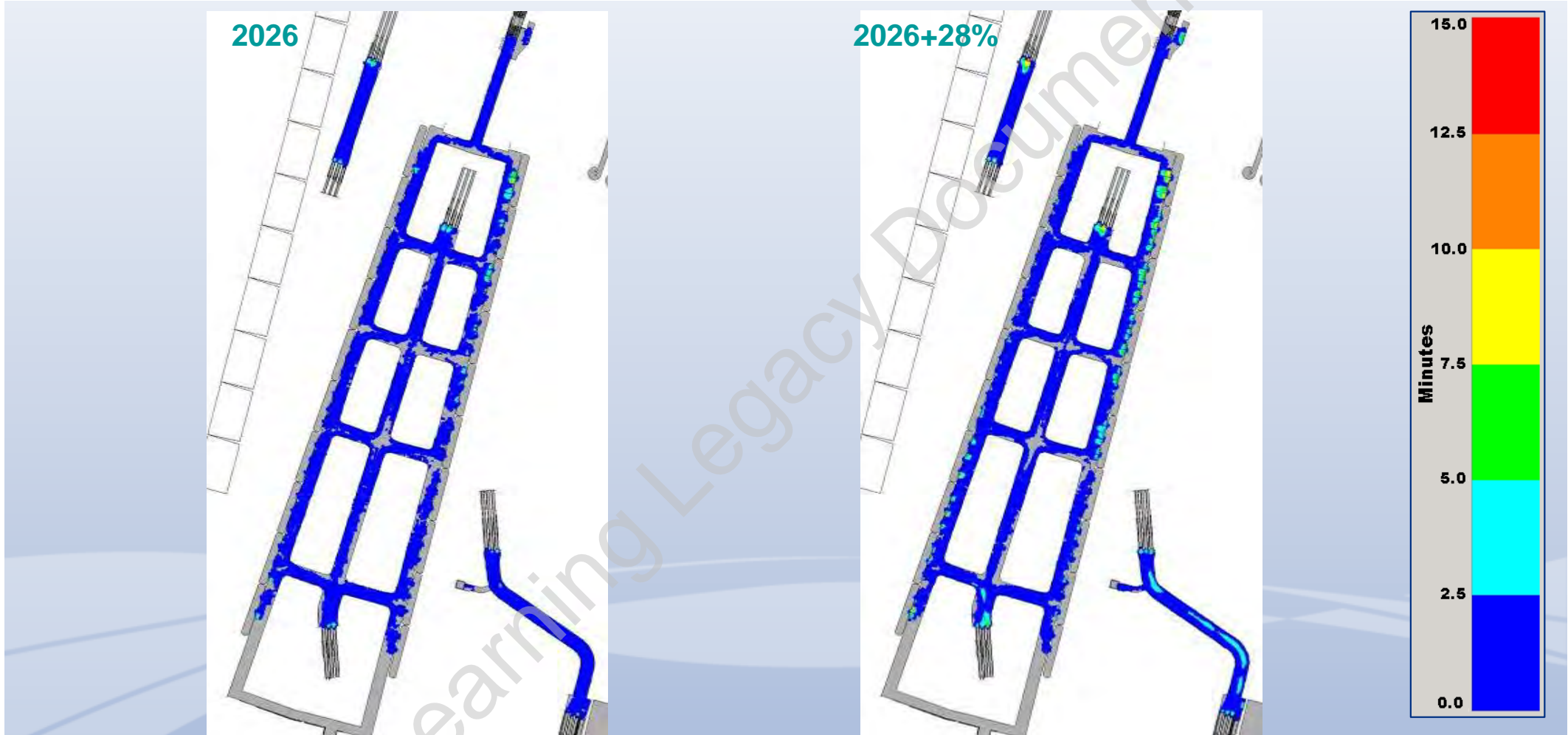

CHD - greater than Walkway LOS C (08:45-09:00)

Crossrail Platforms and Passageways AP2 and AP9: Without Cancelled train

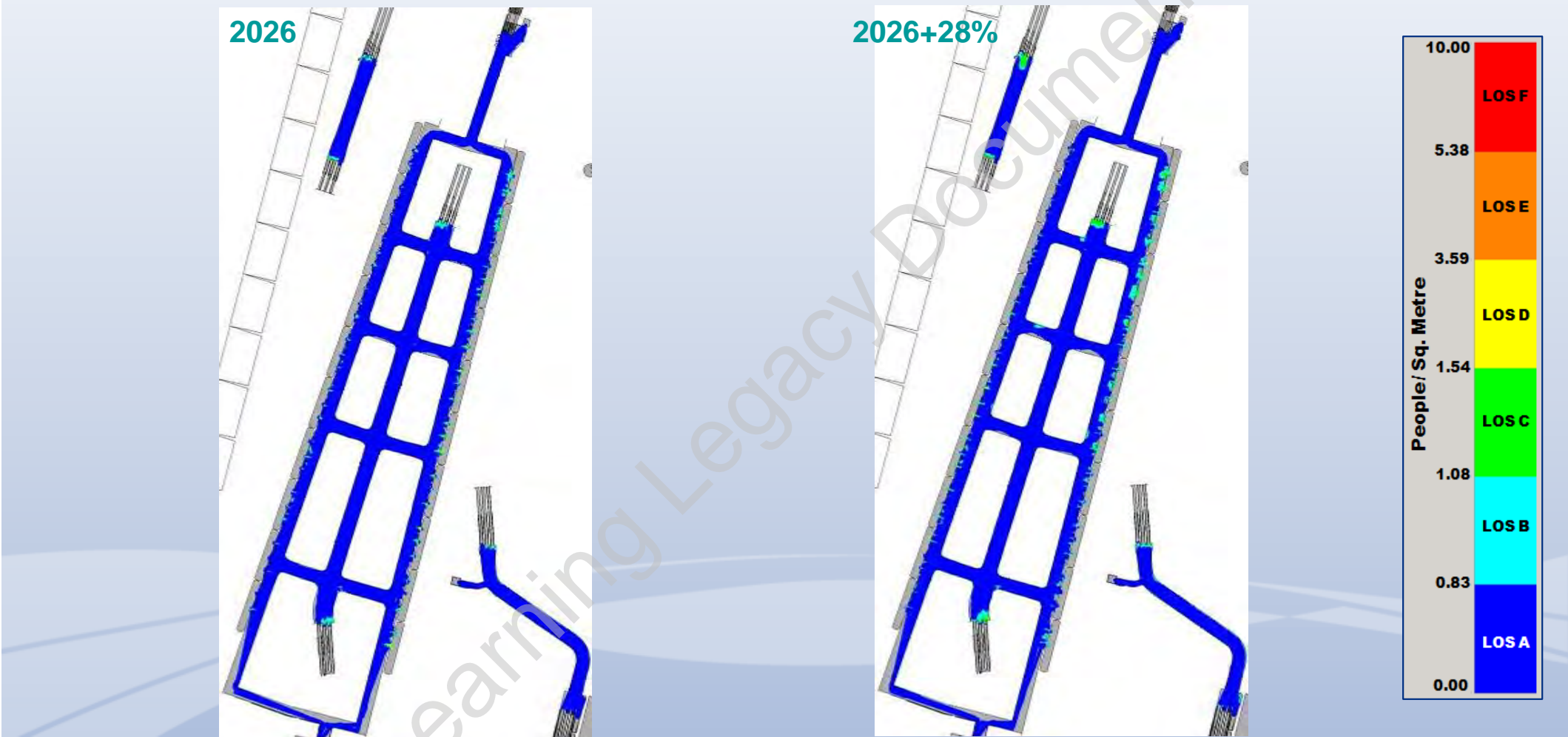

CMD - Queuing LOS (08:30-08:45)

Crossrail Platforms and Passageways AP2 and AP9: Without Cancelled train

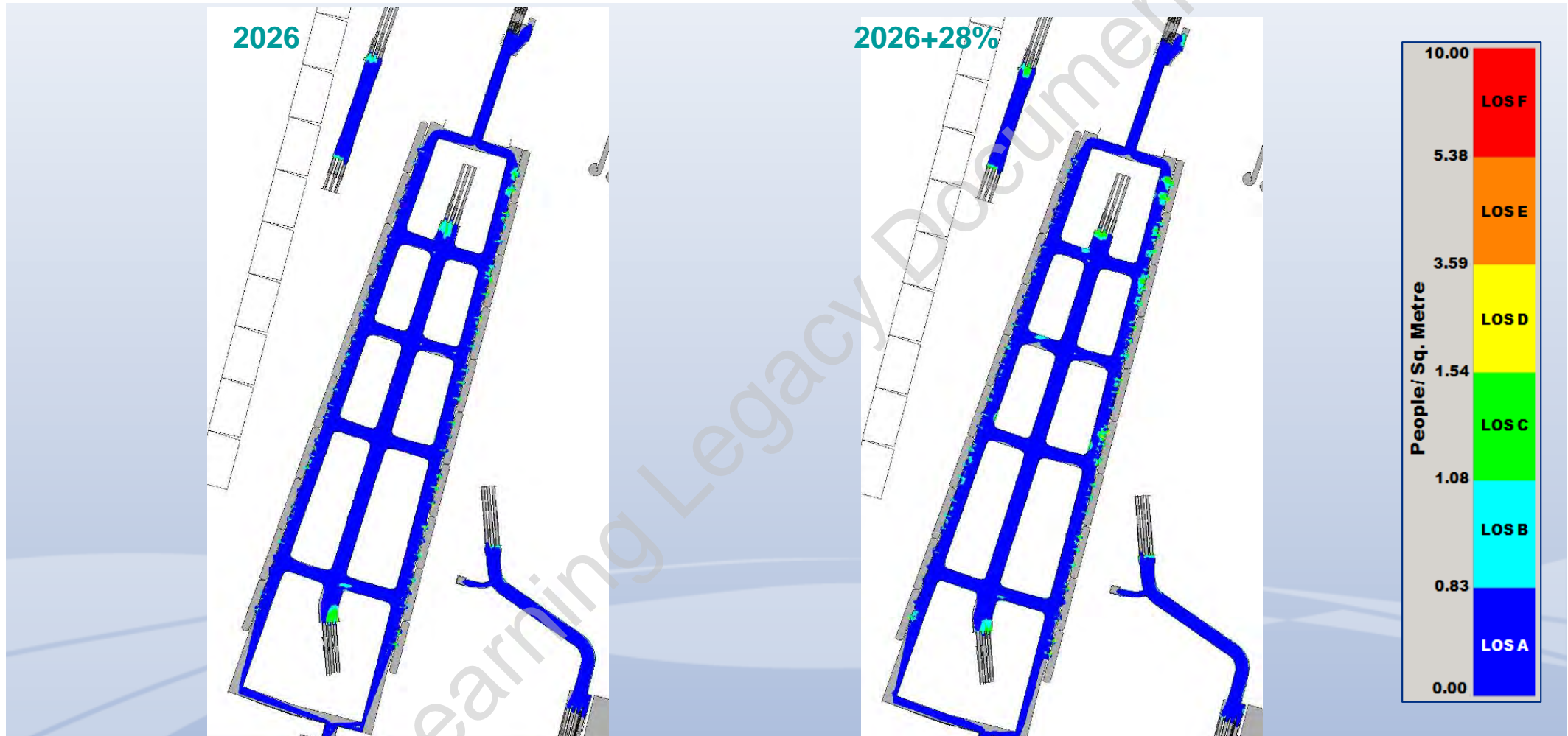

CMD - Queuing LOS (08:45-09:00)

Crossrail Platforms and Passageways AP2 and AP9: Without Cancelled train

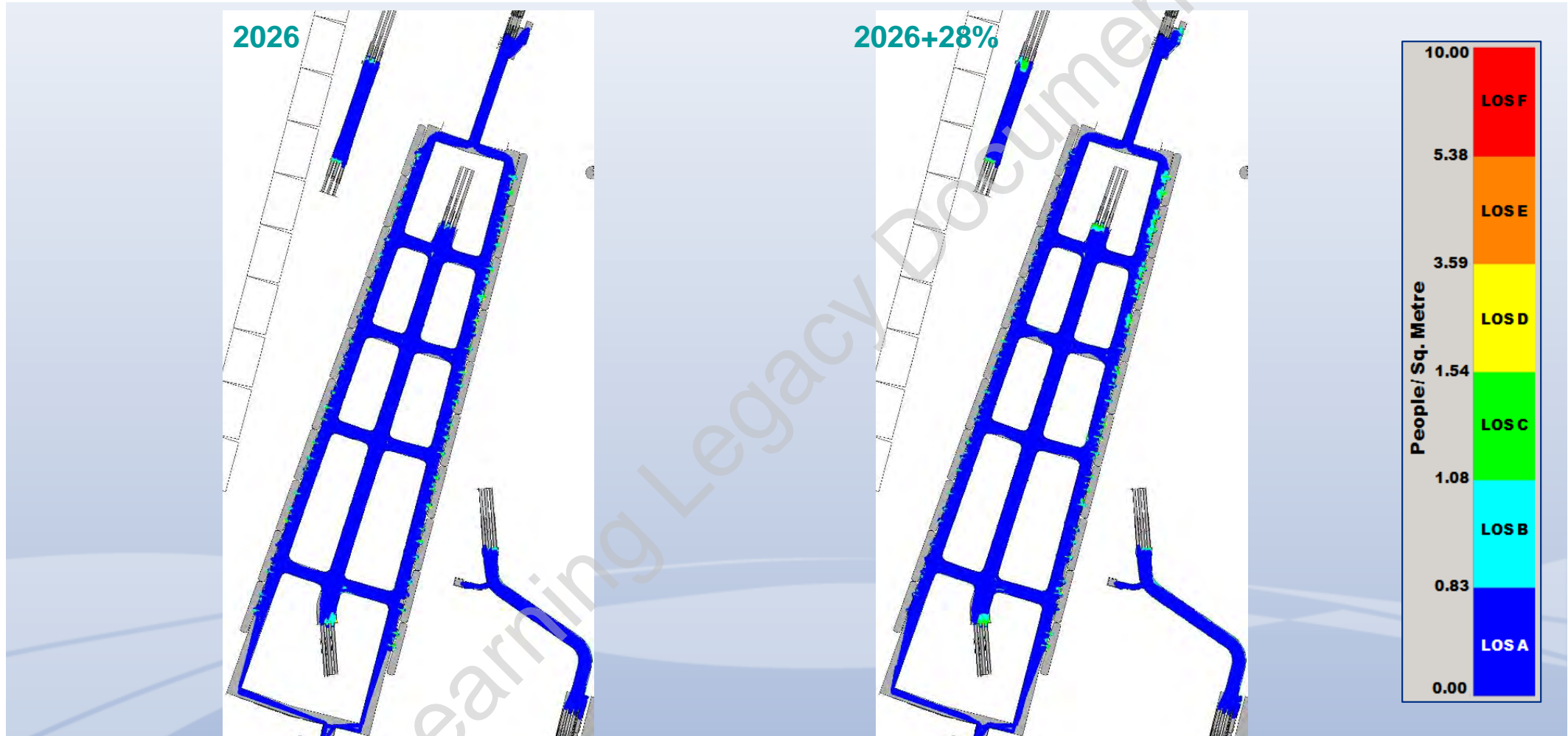

CMD - Queuing LOS (09:00-09:15)

Crossrail Platforms and Passageways AP2 and AP9: Without Cancelled train

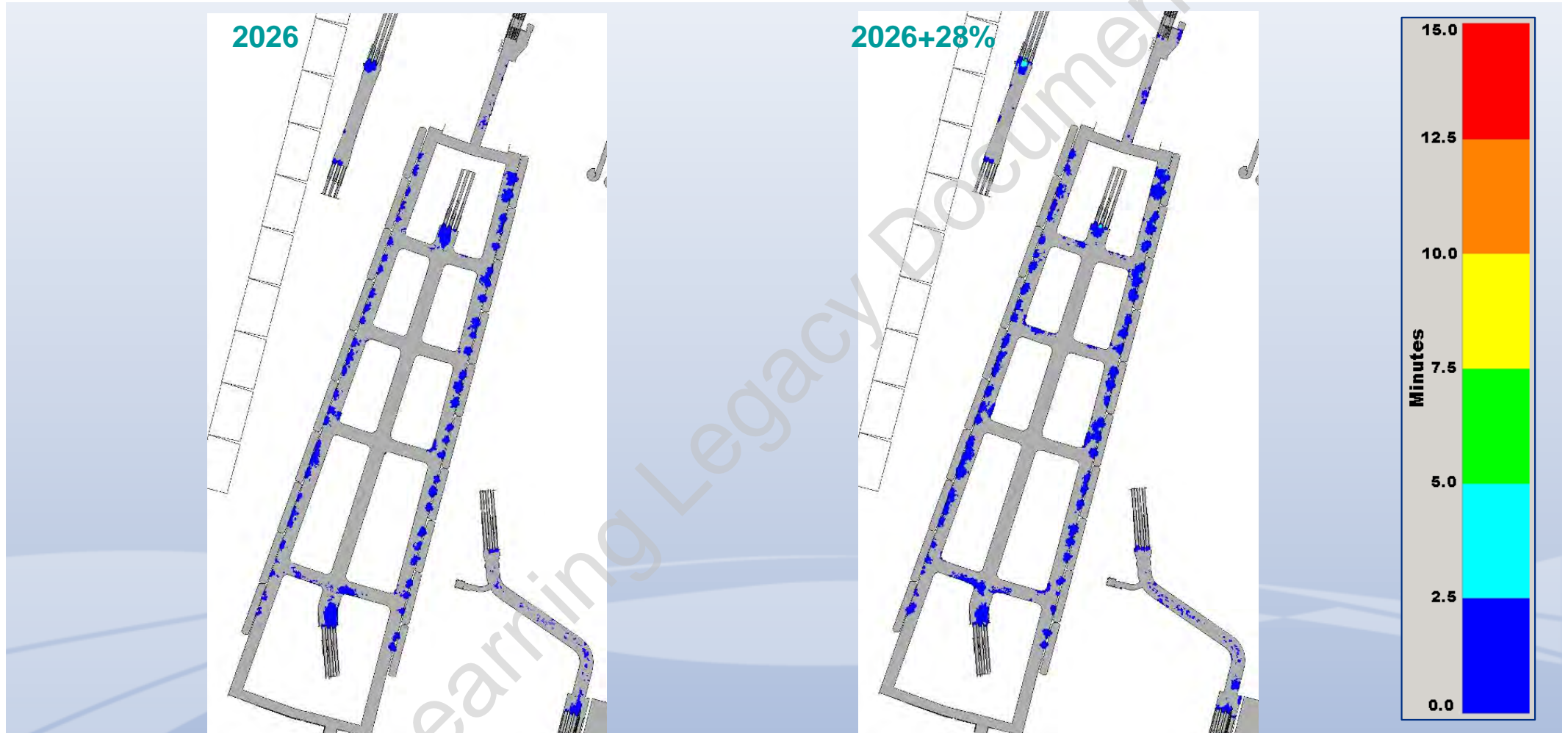

CHD - greater than Queuing LOS C (08:45-09:00)

AM – Scenario

Broadgate Ticket Hall and Liverpool Street Ticket Hall B

Broadgate Ticket Hall and Liverpool Street Ticket Hall B

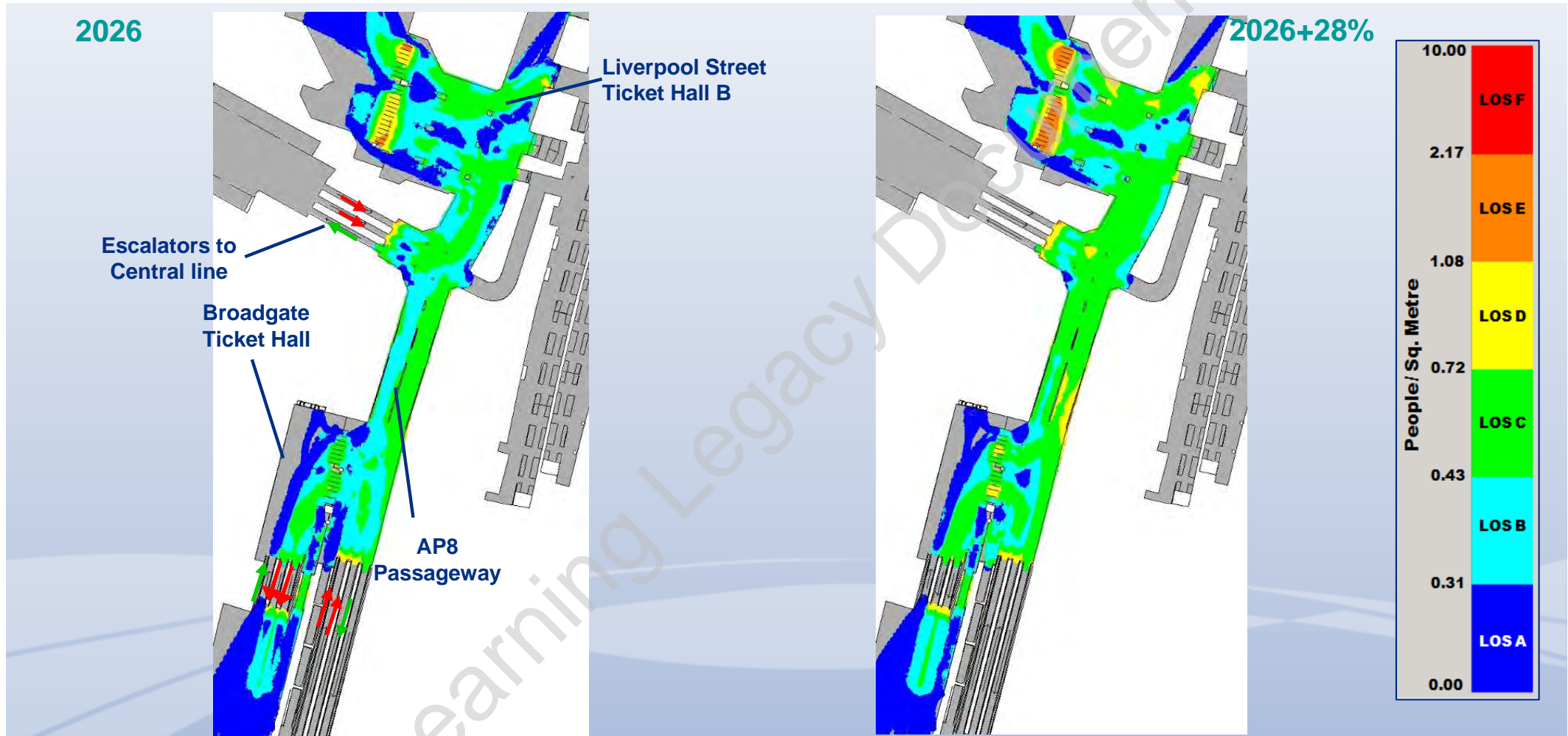

CMD - Walkway LOS (08:45-09:00)

Escalator travel direction ↓ Down ↑ Up

Broadgate Ticket Hall and Liverpool Street Ticket Hall B

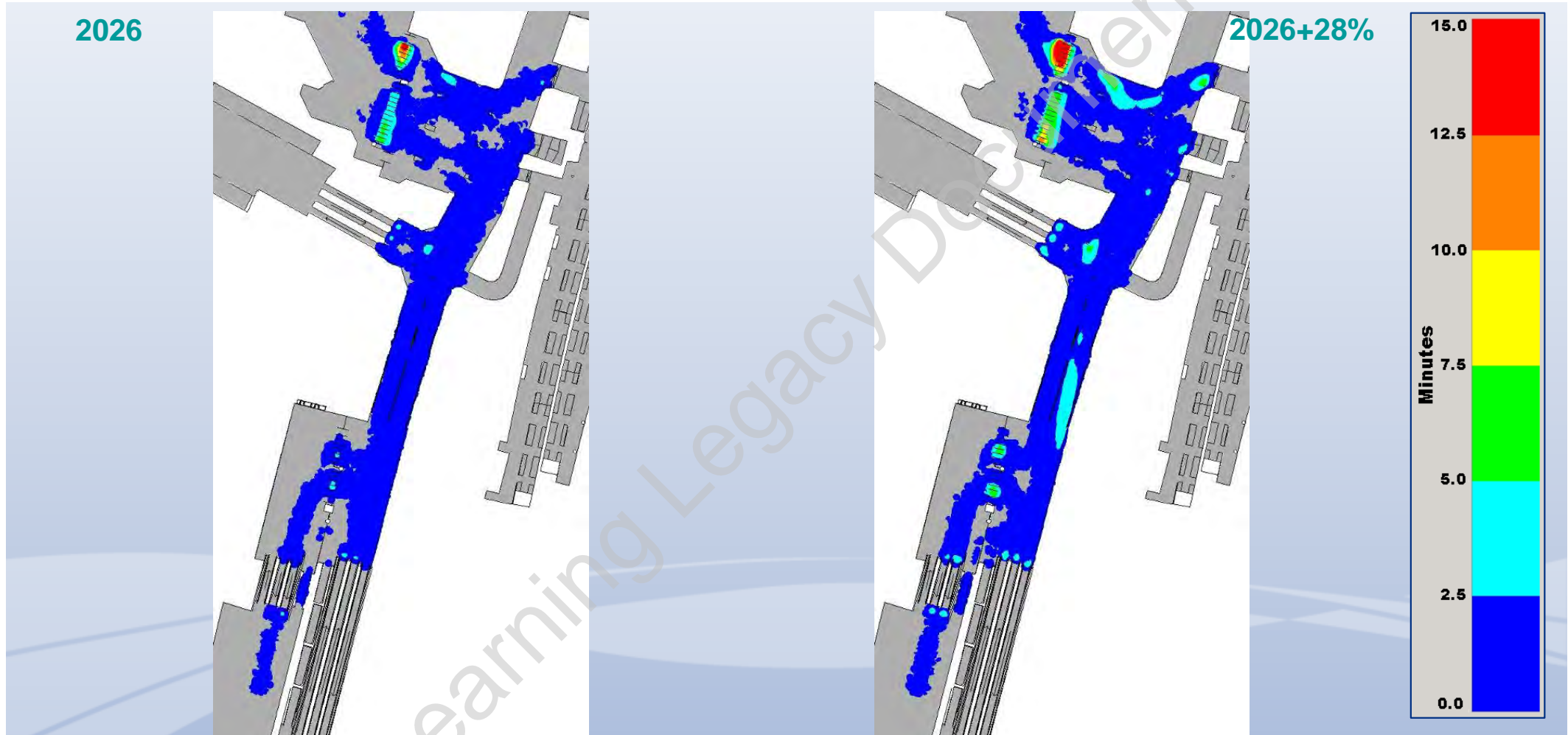

CHD - greater than Walkway LOS C (08:45-09:00)

Broadgate Ticket Hall and Liverpool Street Ticket Hall B

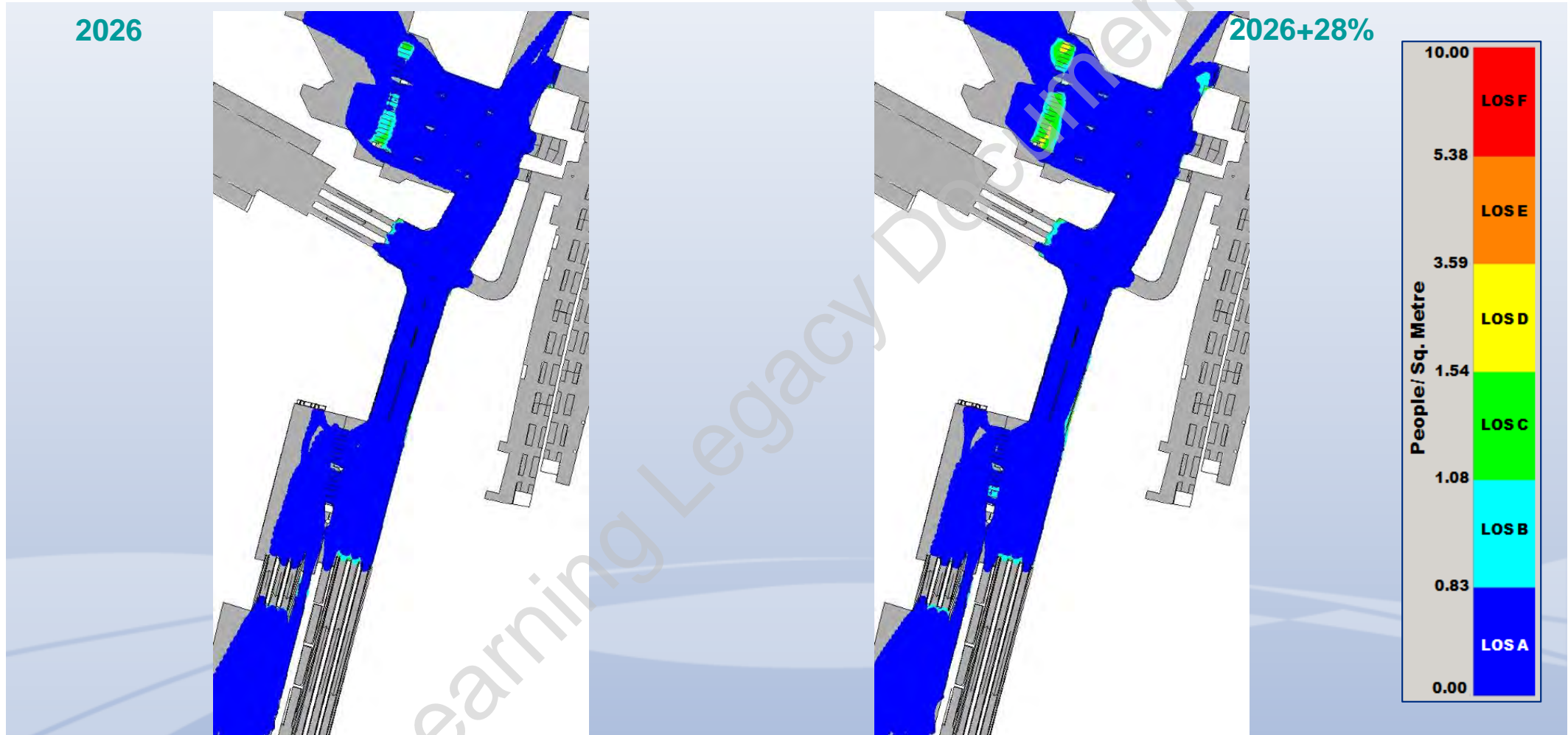

CMD - Queuing LOS (08:45-09:00)

Broadgate Ticket Hall and Liverpool Street Ticket Hall B

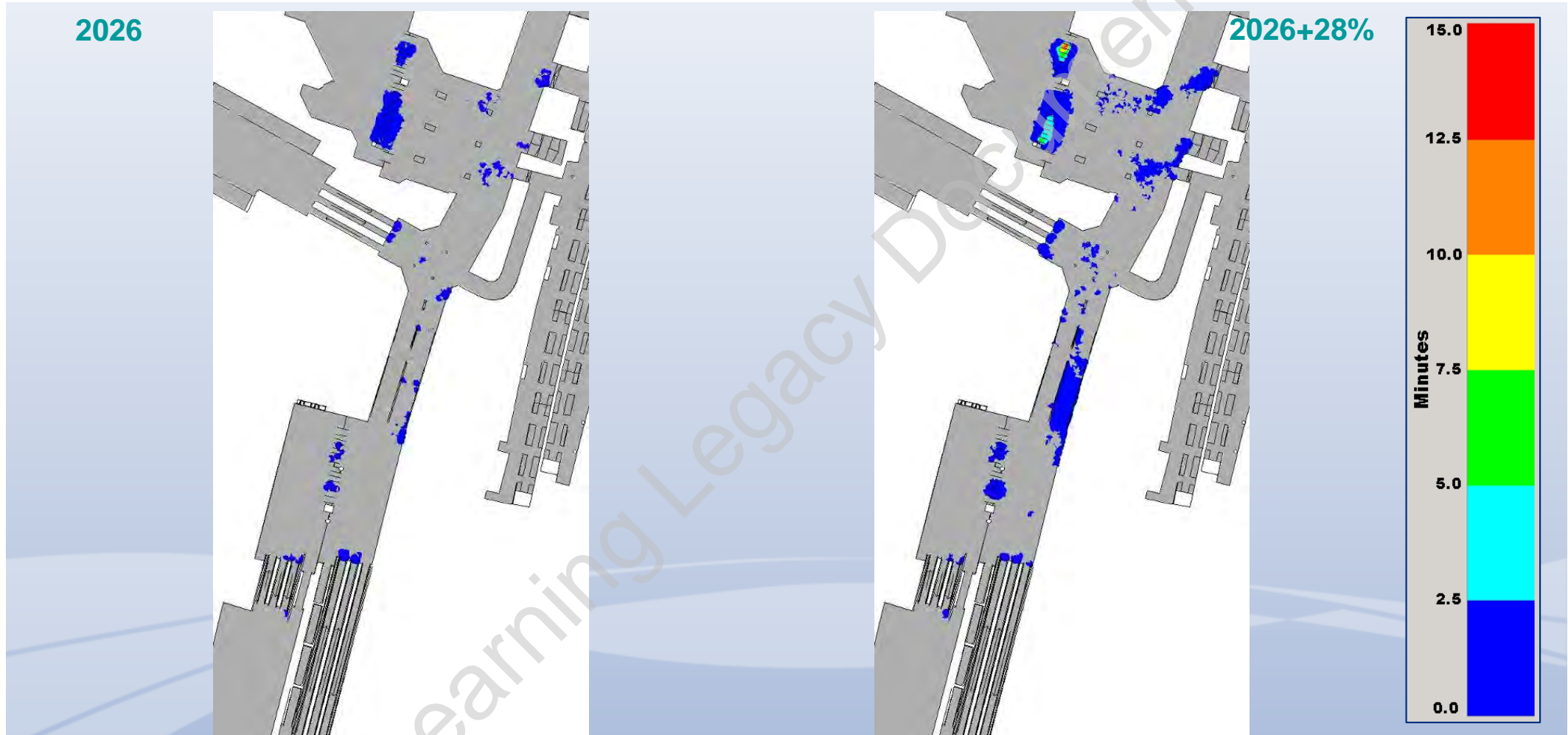

CHD - greater than Queuing LOS C (08:45-09:00)

PM – Scenario

Integrated Moorgate Ticket Hall

Integrated Moorgate Ticket Hall

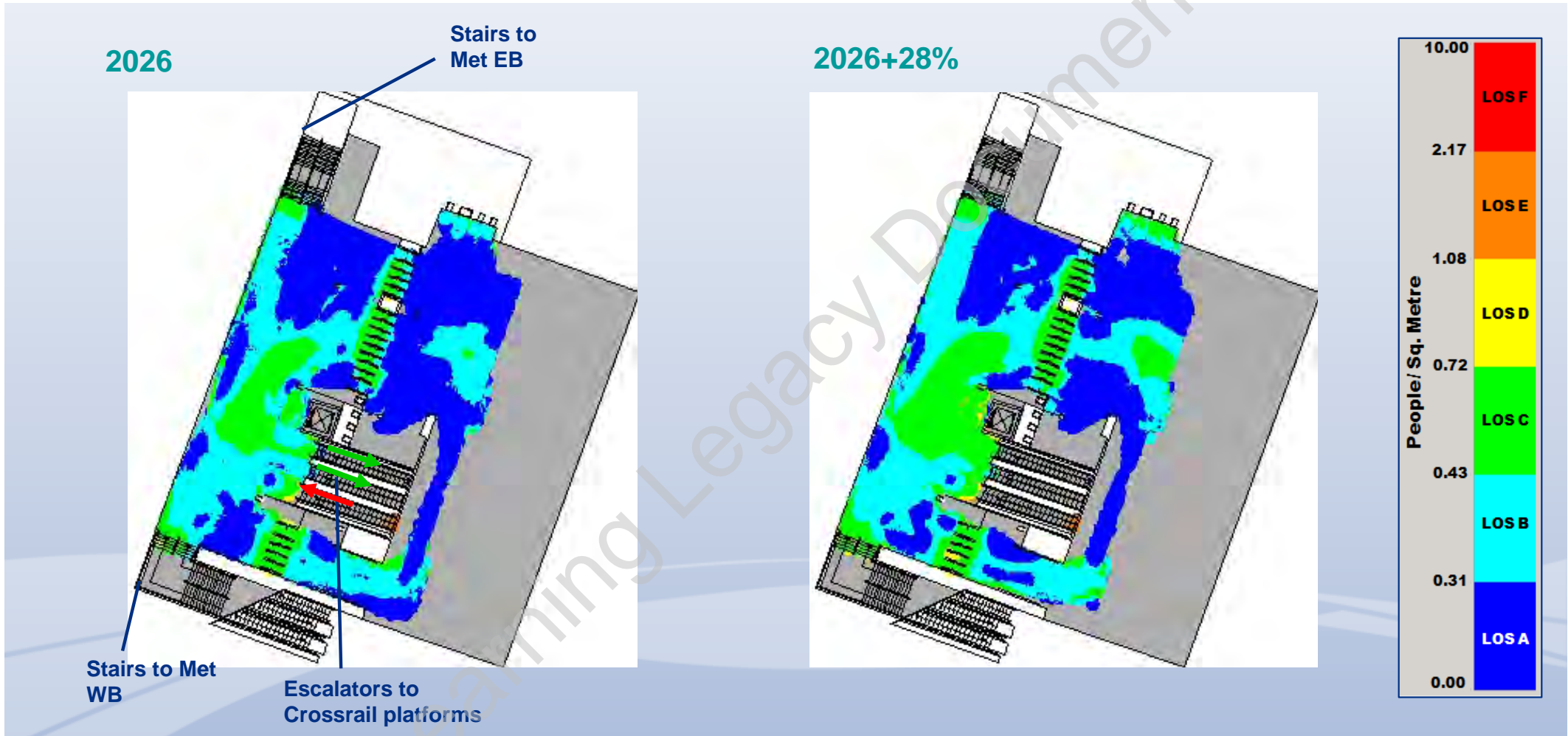

CMD - Walkway LOS (17:45-18:00)

Escalator travel direction ↓ Down ↑ Up

Integrated Moorgate Ticket Hall

2026

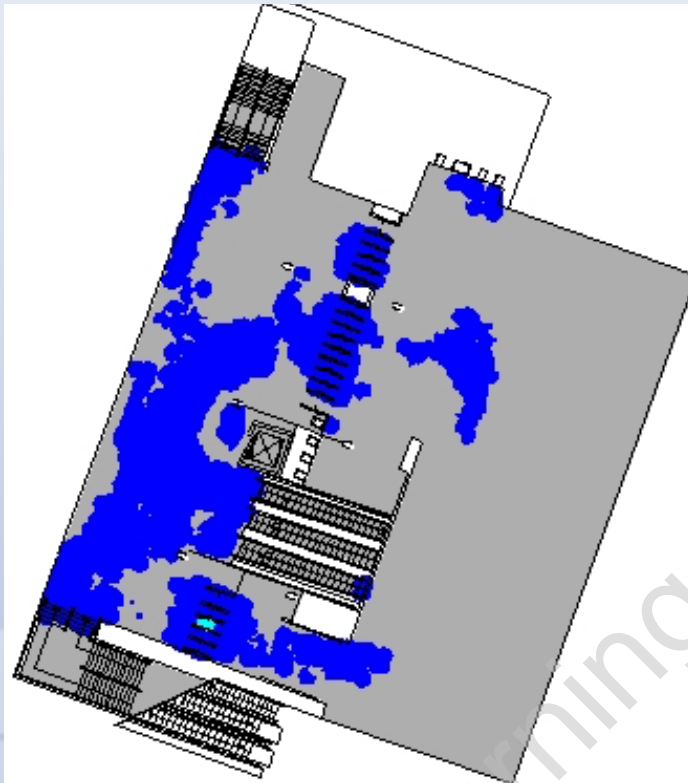

2026+28%

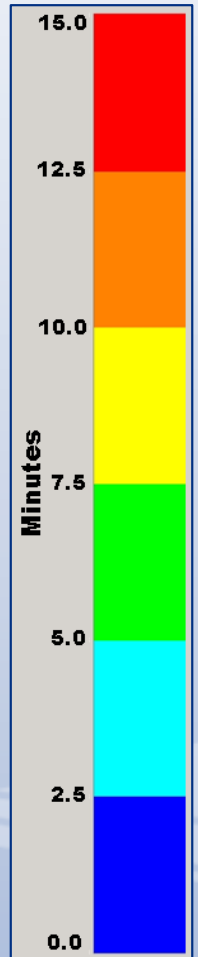
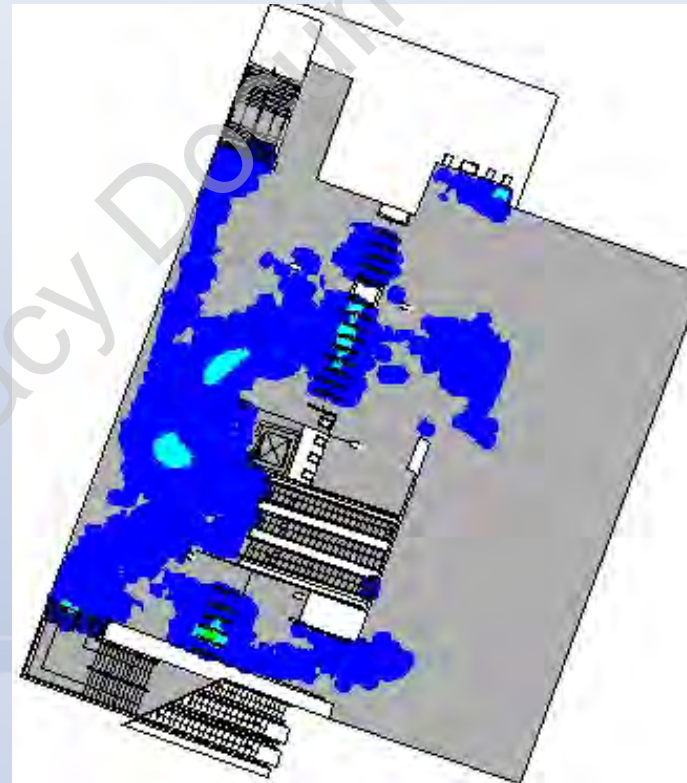

CHD - greater than Walkway LOS C (17:45-18:00)

Integrated Moorgate Ticket Hall

2026

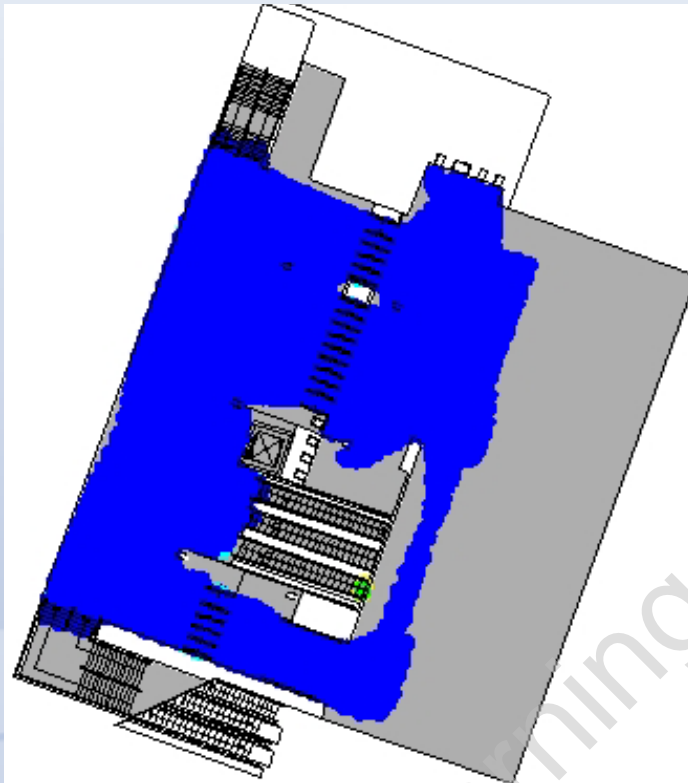

2026+28%

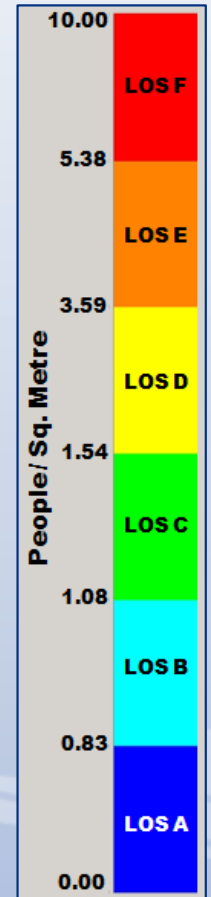
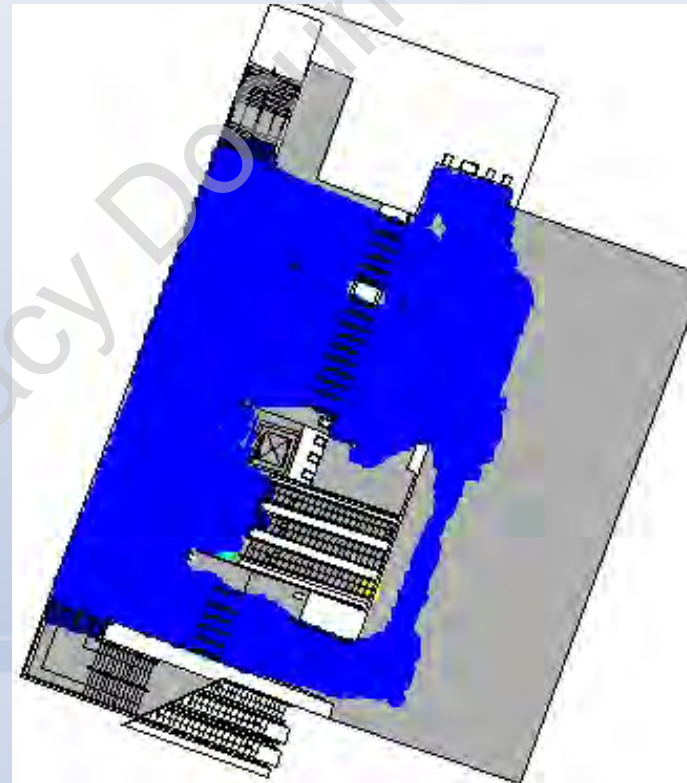

CMD - Queuing LOS (17:45-18:00)

Integrated Moorgate Ticket Hall

2026

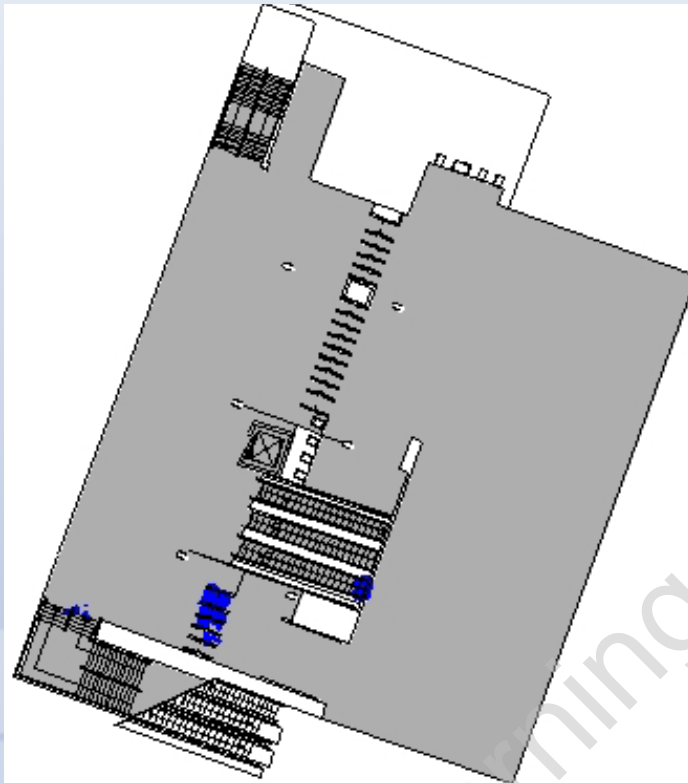

2026+28%

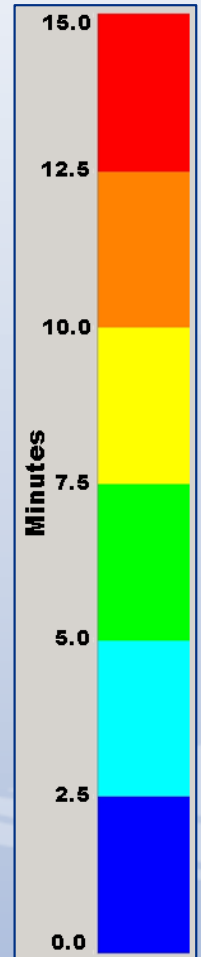
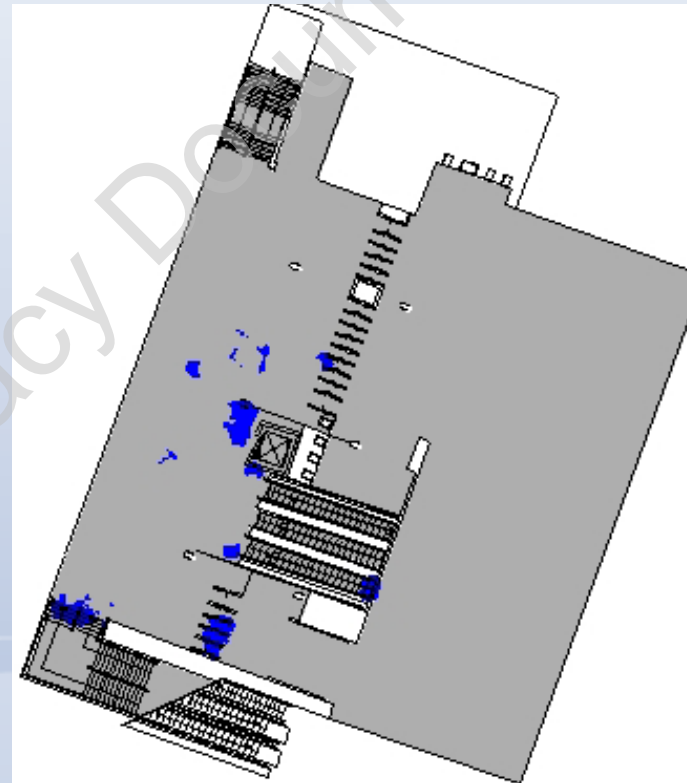

CHD - greater than Queuing LOS C (17:45-18:00)

PM – Scenario

Northern Line Link (NLL), Northern Line Platforms and FCC Platforms

NLL, Northern Line and the FCC Platforms

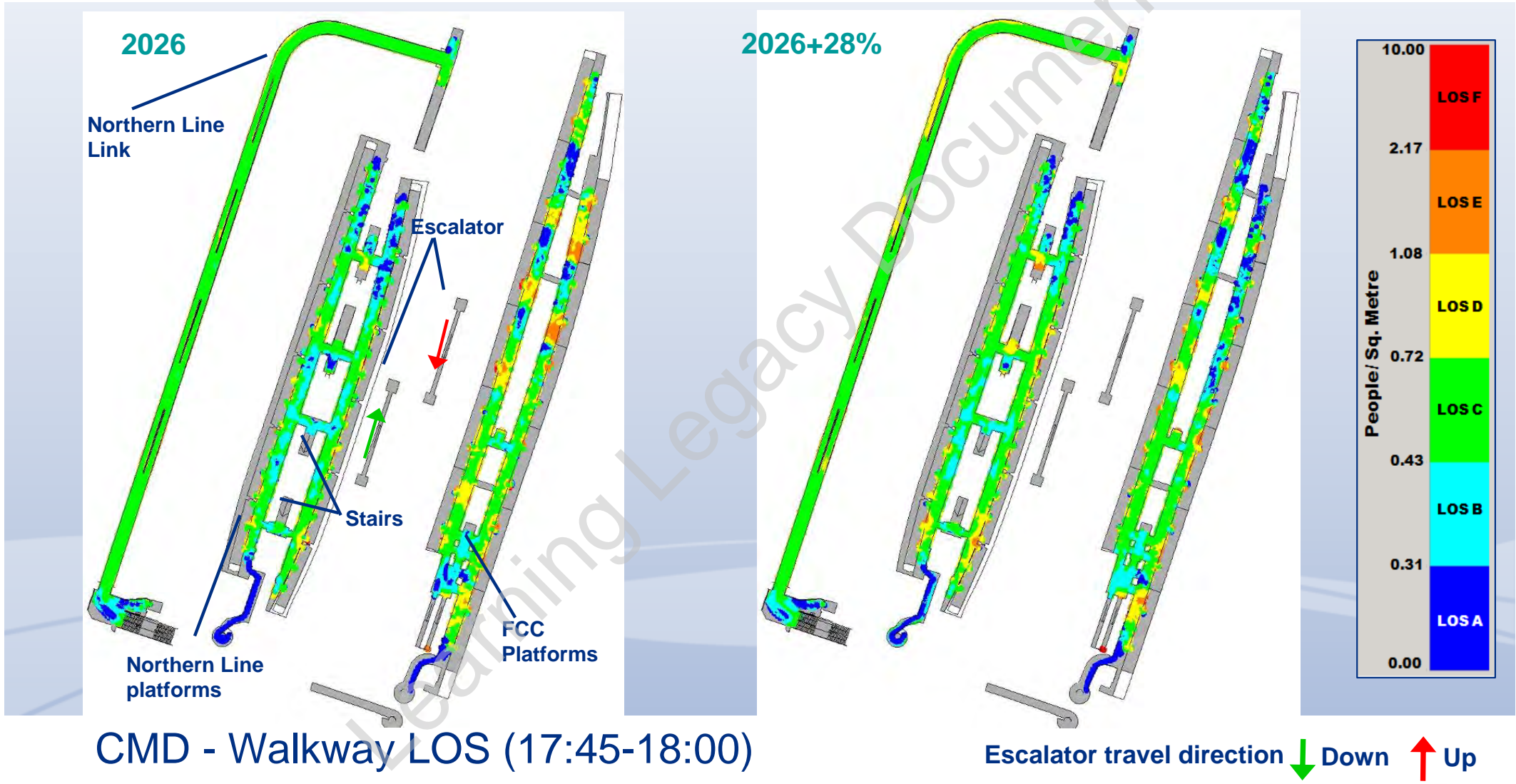

NLL, Northern Line and the FCC Platforms

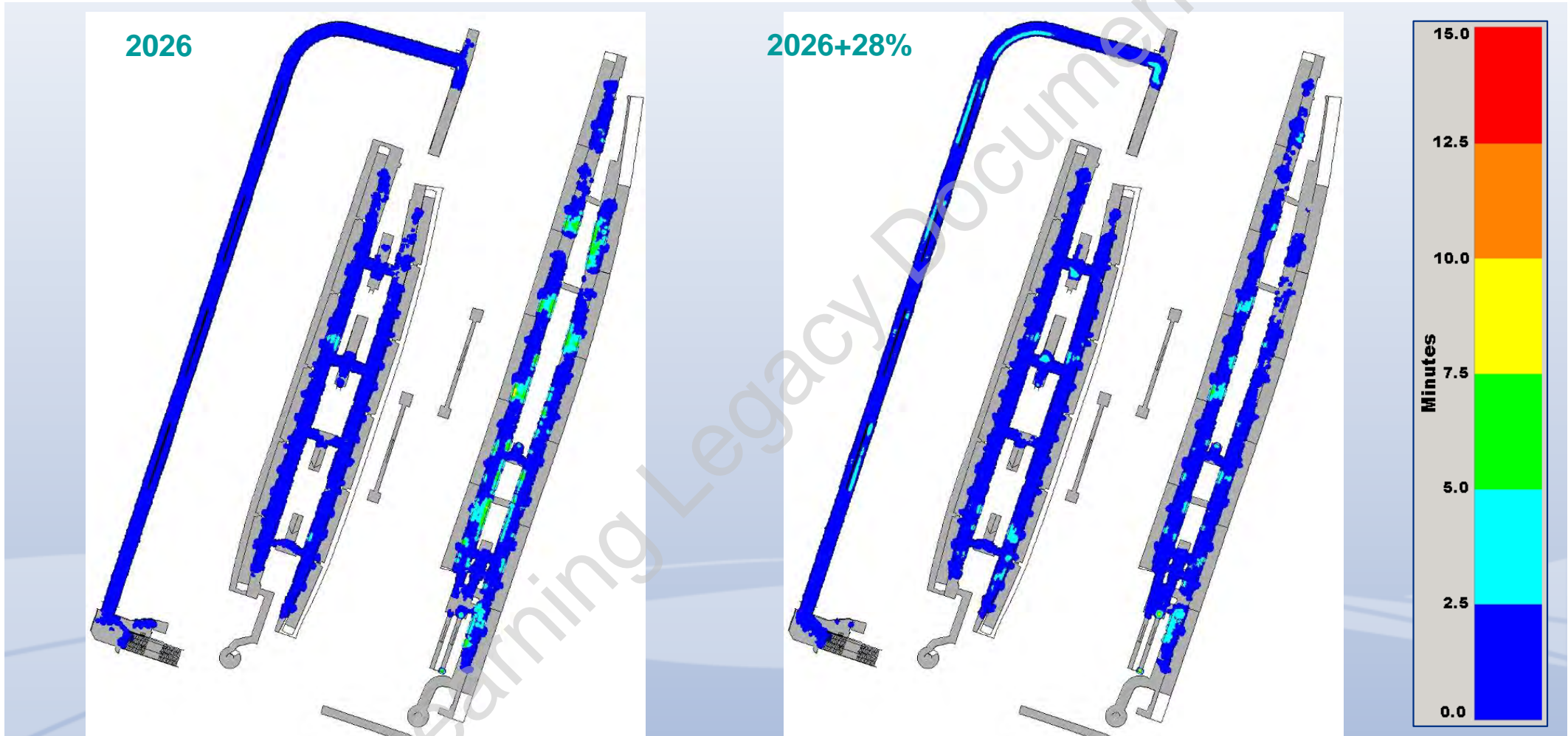

CHD - greater than Walkway LOS C (17:45-18:00)

NLL, Northern Line and the FCC Platforms

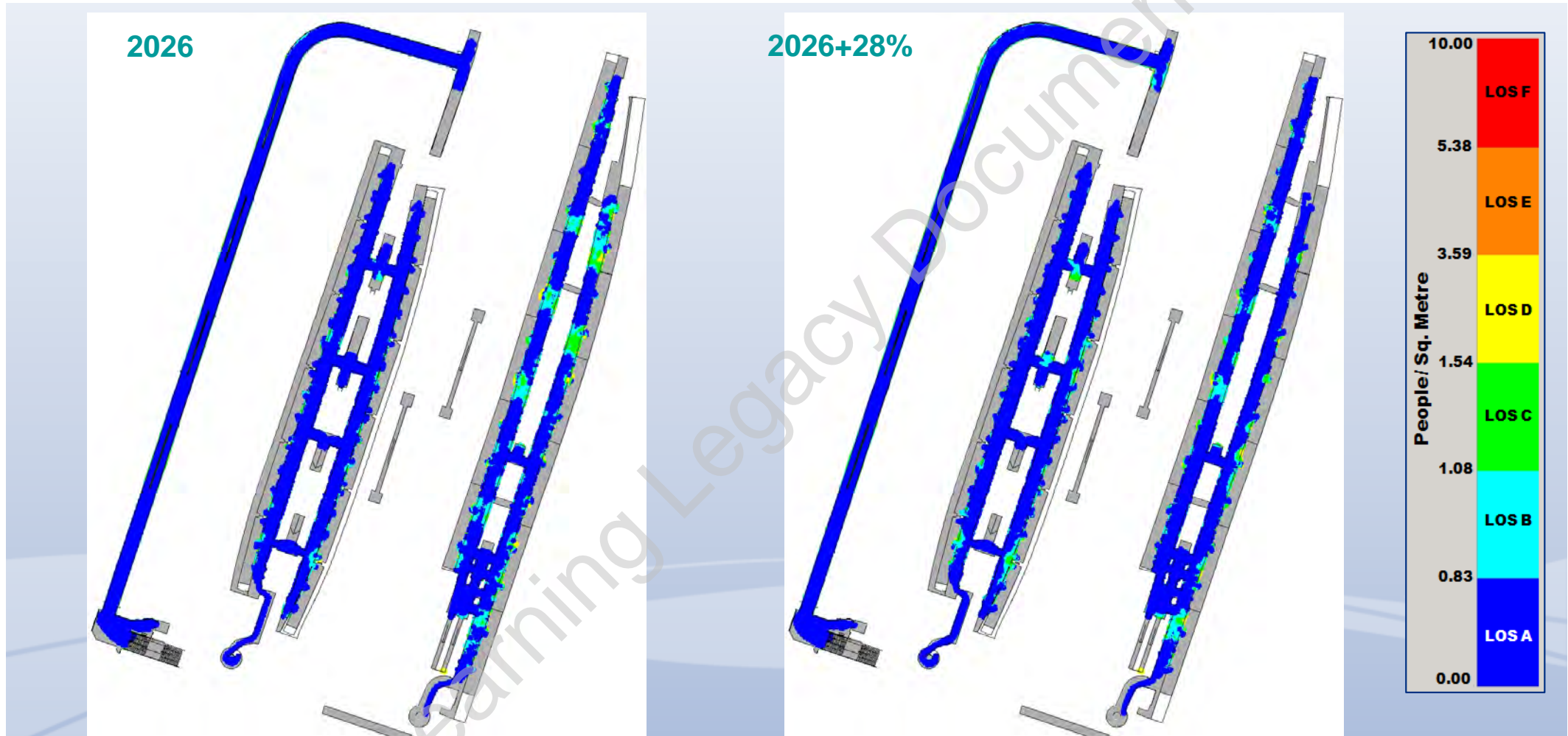

CMD - Queuing LOS (17:45-18:00)

NLL, Northern Line and the FCC Platforms

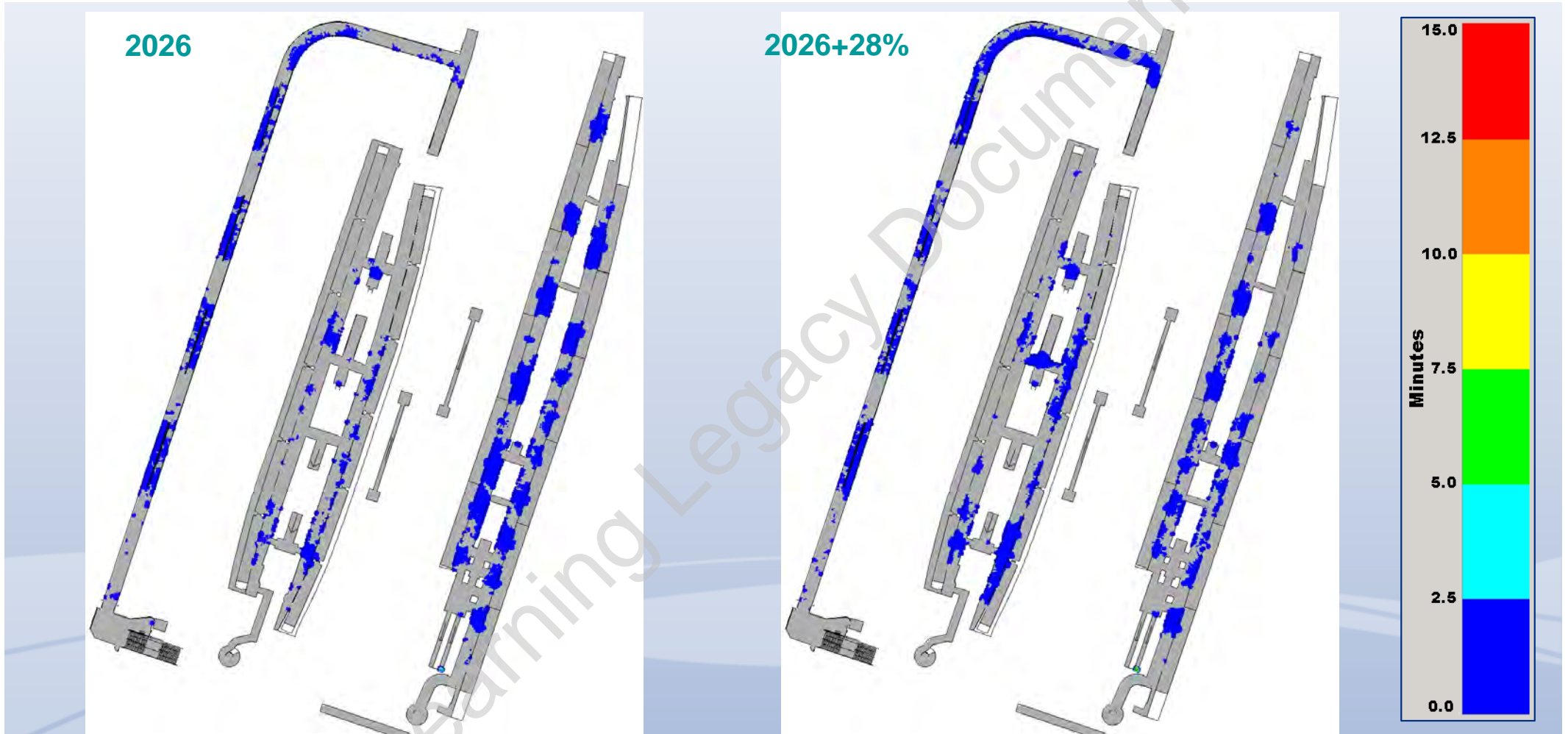

CHD - greater than Queuing LOS C (17:45-18:00)

NLL, Northern Line and the FCC Platforms

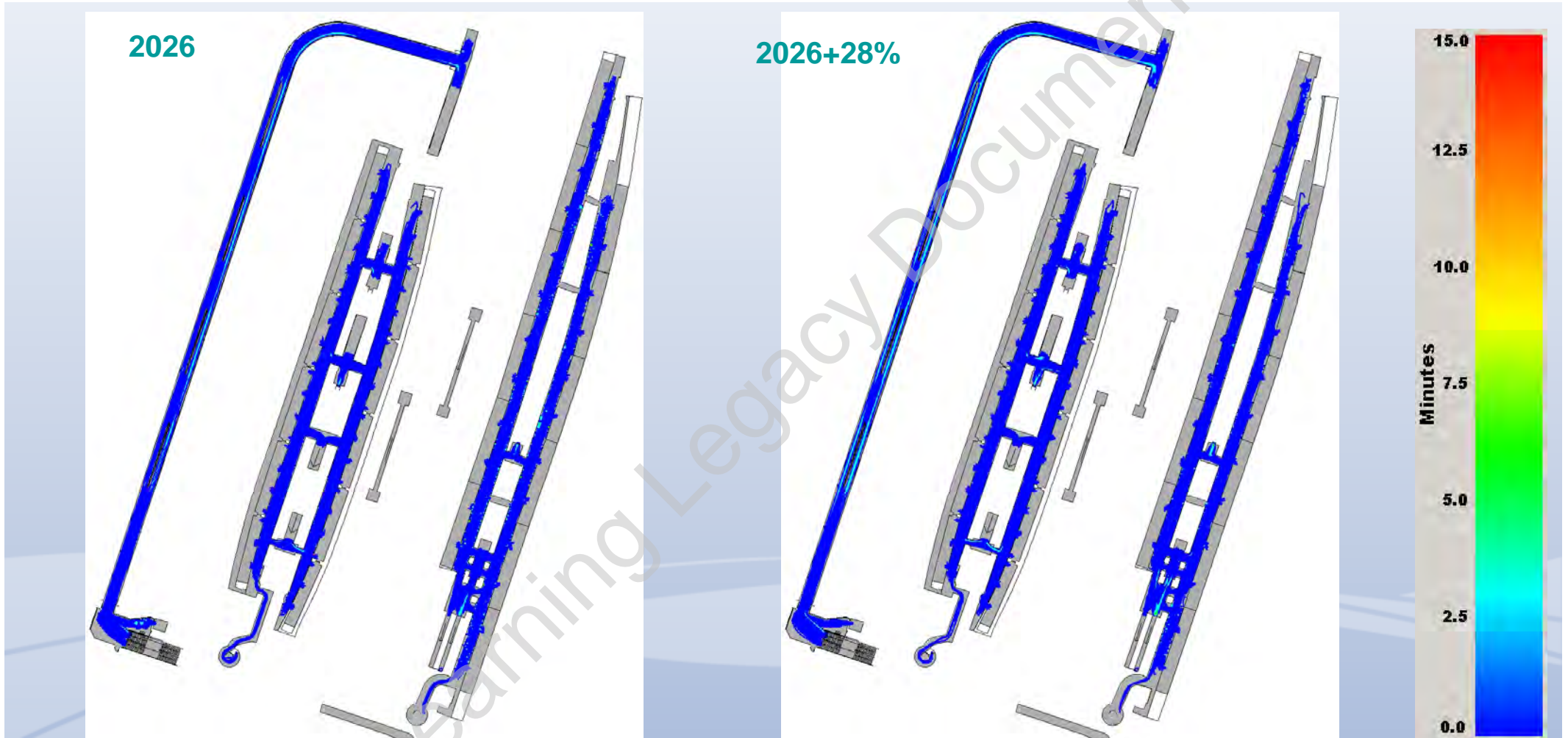

Space Utilisation (17:45-18:00)

Learning Legacy Document

PM – Scenario

Existing Moorgate Ticket Hall

Existing Moorgate Ticket Hall

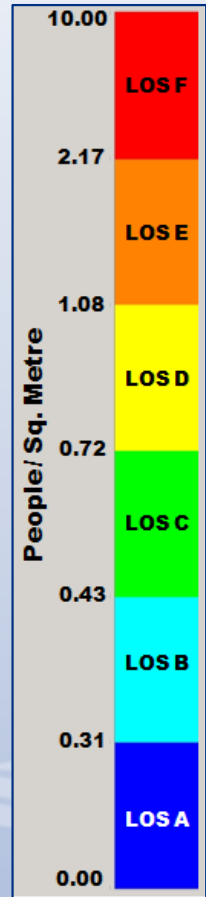
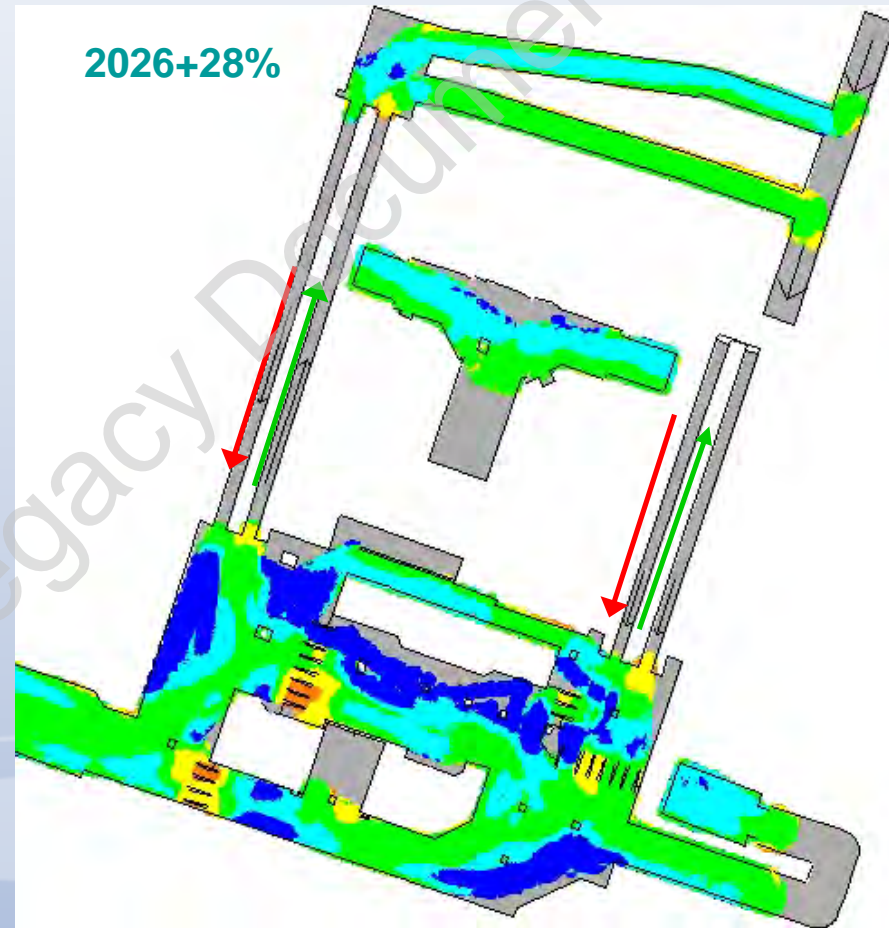
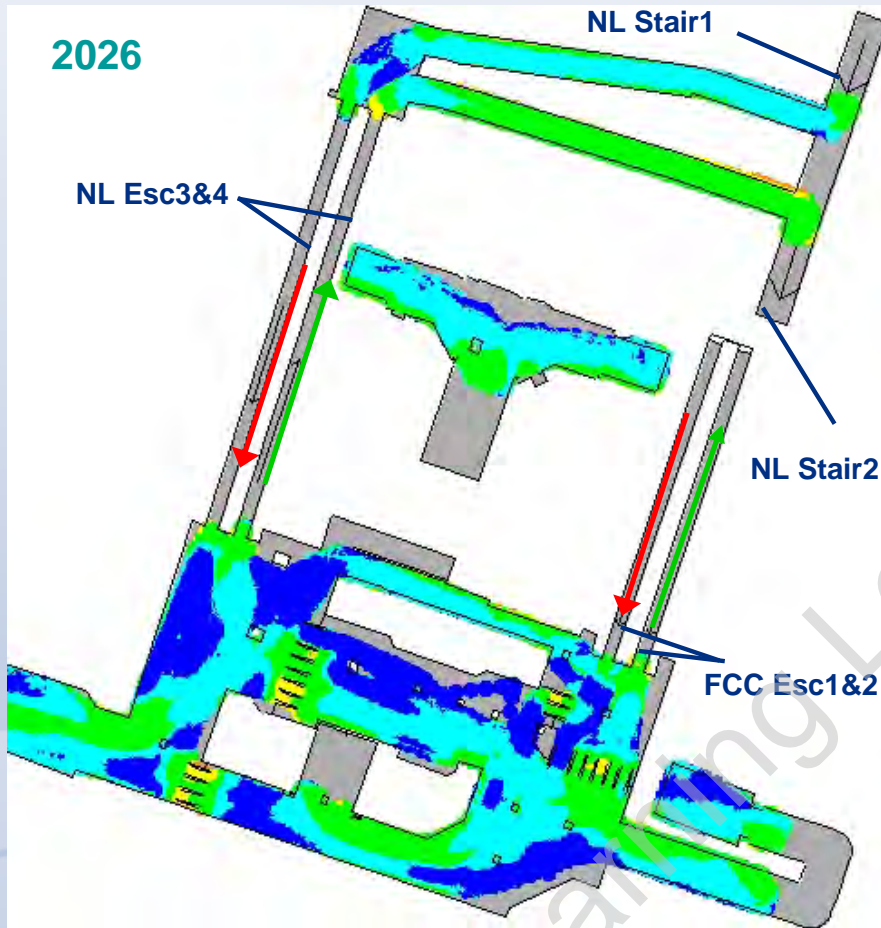

CMD - Walkway LOS (17:45-18:00)

Escalator travel direction ↓ Down ↑ Up

Existing Moorgate Ticket Hall

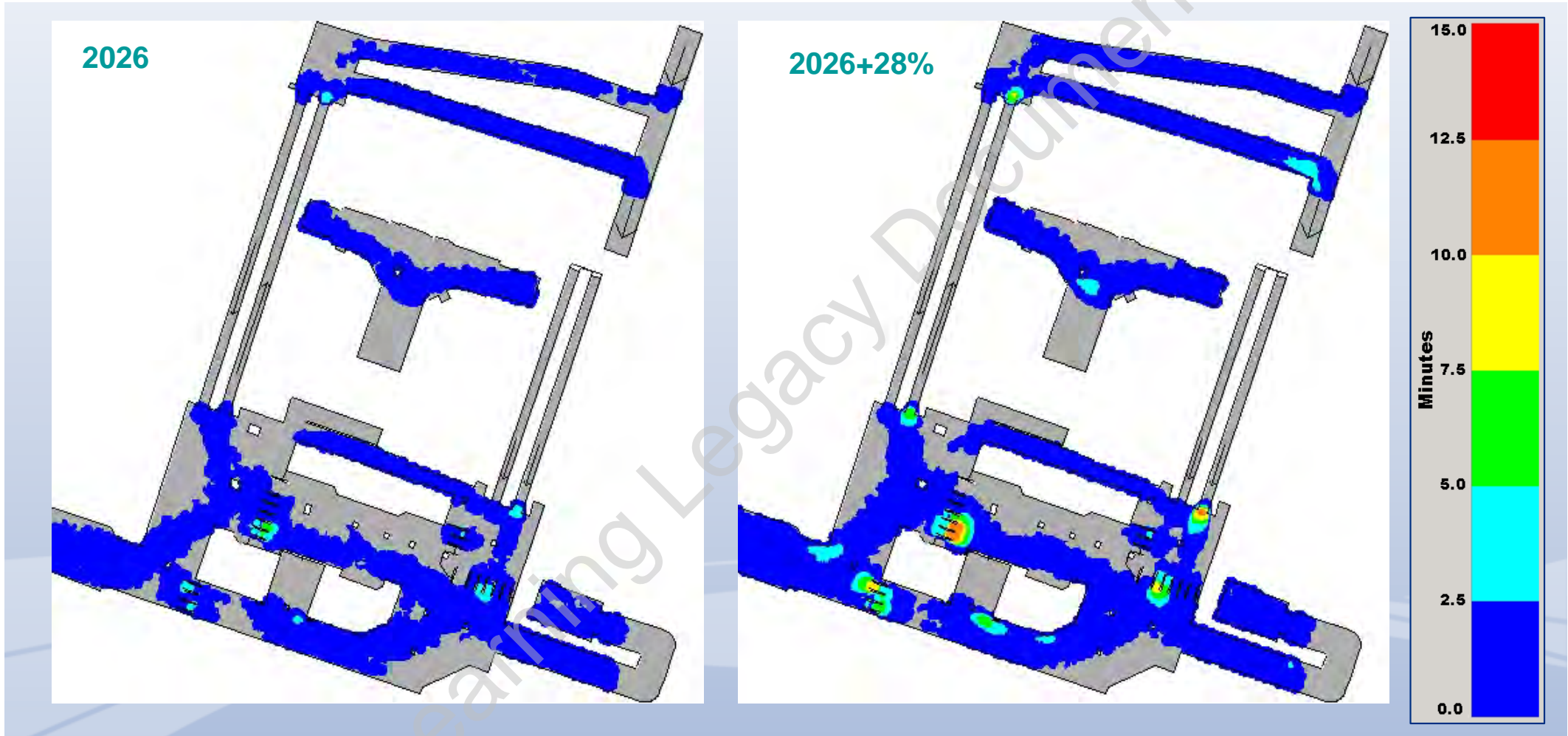

CHD - greater than Walkway LOS C (17:45-18:00)

Existing Moorgate Ticket Hall

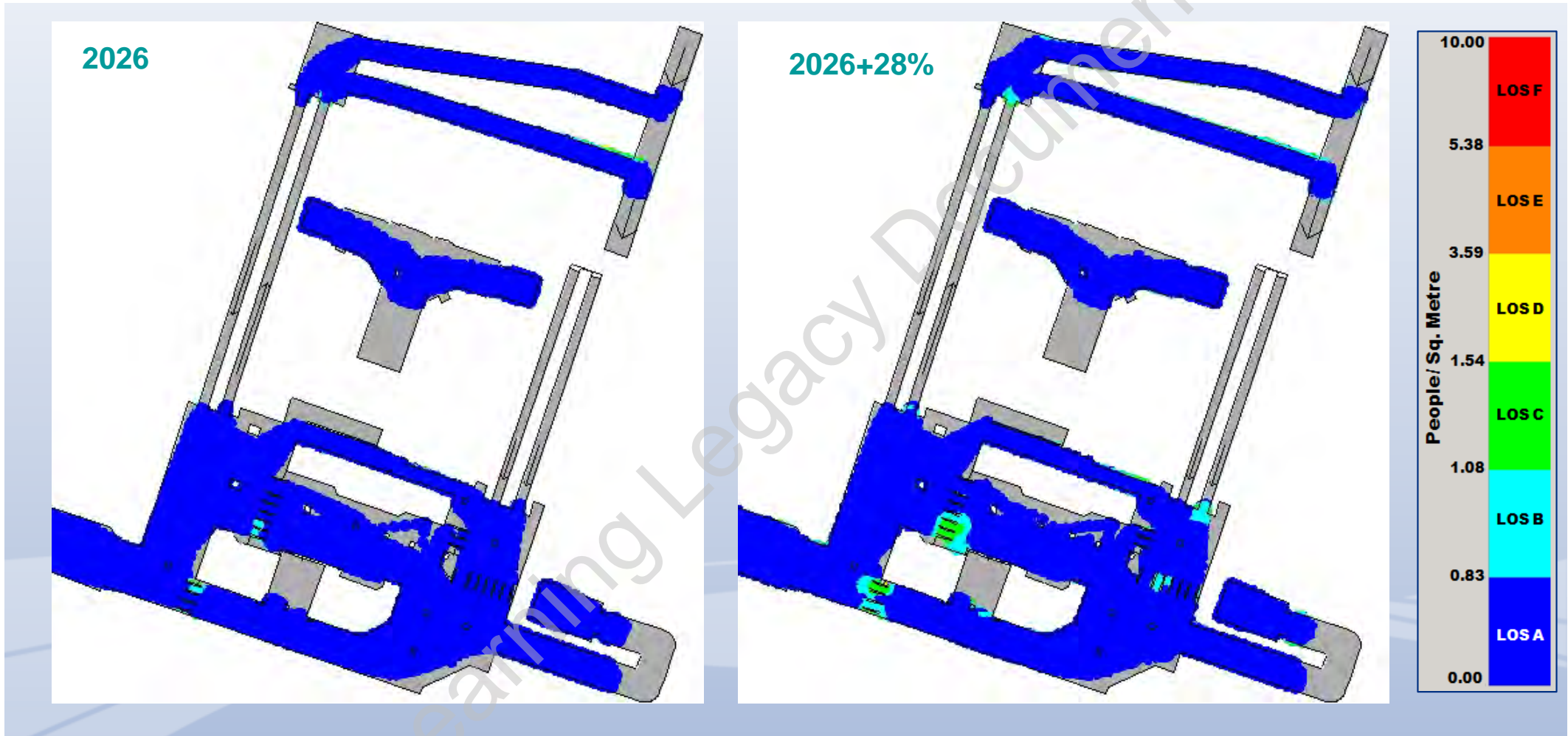

CMD - Queuing LOS (17:45-18:00)

Existing Moorgate Ticket Hall

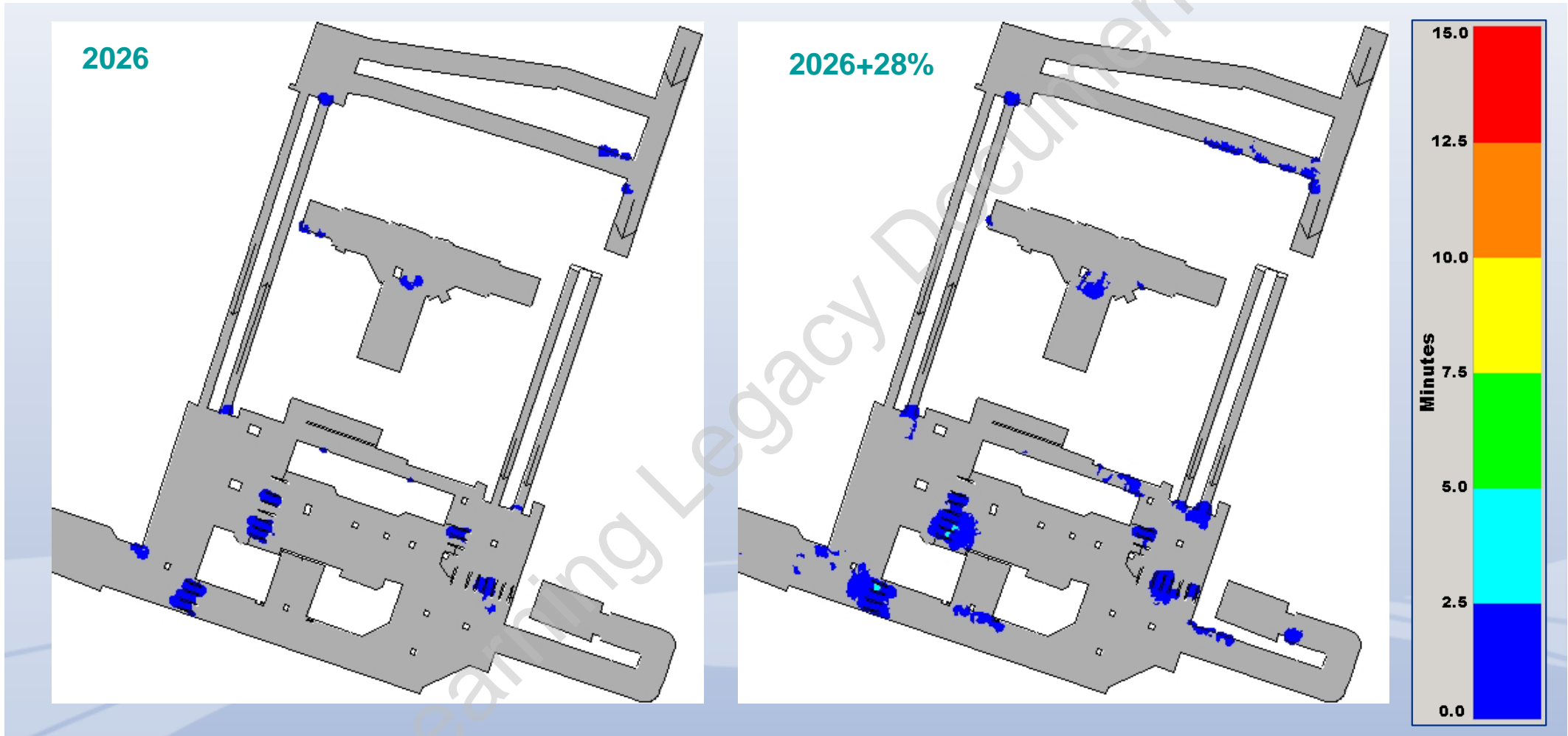

CHD - greater than Queuing LOS C (17:45-18:00)

PM – Scenario

Crossrail Platforms and Passageways AP2 and AP9

Crossrail Platforms and Passageways AP2 and AP9

- In relation to the Crossrail platforms only, Legion modelling output will be shown for the following peak 15 minute periods:
 - 17:30 – 17:45
 - 17:45 – 18:00
 - 18:00 – 18:15
- Modelling output will also be presented for the following train service scenarios:
 - Non-perturbed (i.e. no cancelled train),
 - Perturbed train service (i.e. cancelled eastbound train during the peak 15 minutes).

Crossrail Platforms and Passageways AP2 and AP9



CMD - Walkway LOS (17:30-17:45)

Crossrail Platforms and Passageways AP2 and AP9

2026

No Cancelled train

Cancelled train

2026+28%

No Cancelled train

Cancelled train

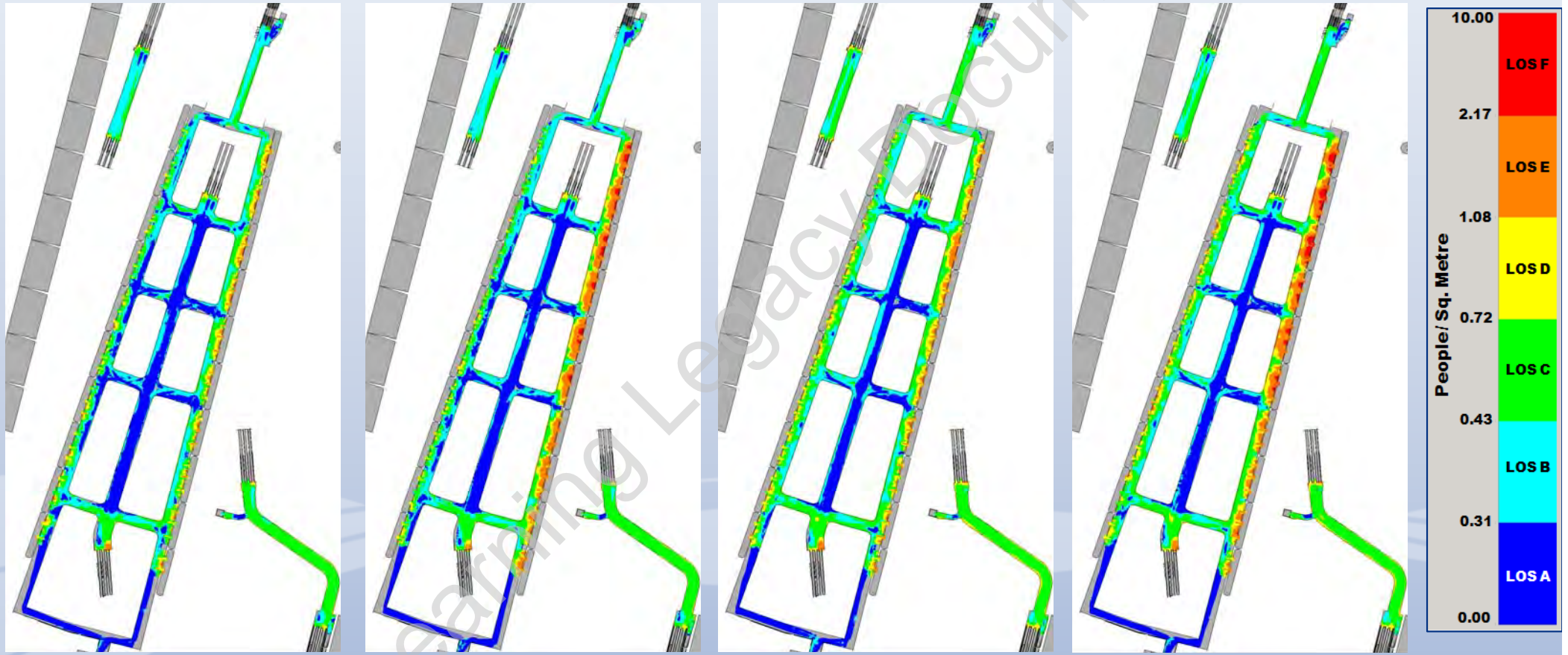

CMD - Walkway LOS (17:45-18:00)

Crossrail Platforms and Passageways AP2 and AP9

2026

2026+28%

No Cancelled train

Cancelled train

No Cancelled train

Cancelled train

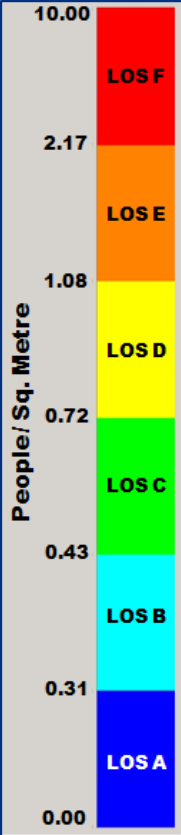
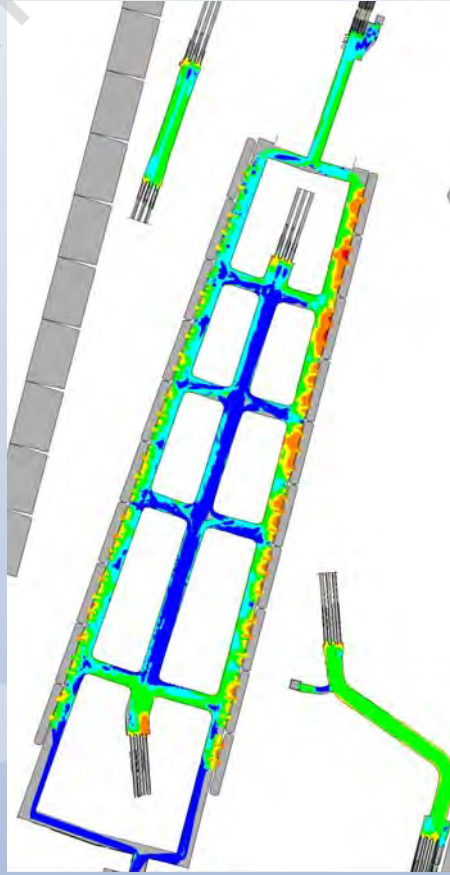
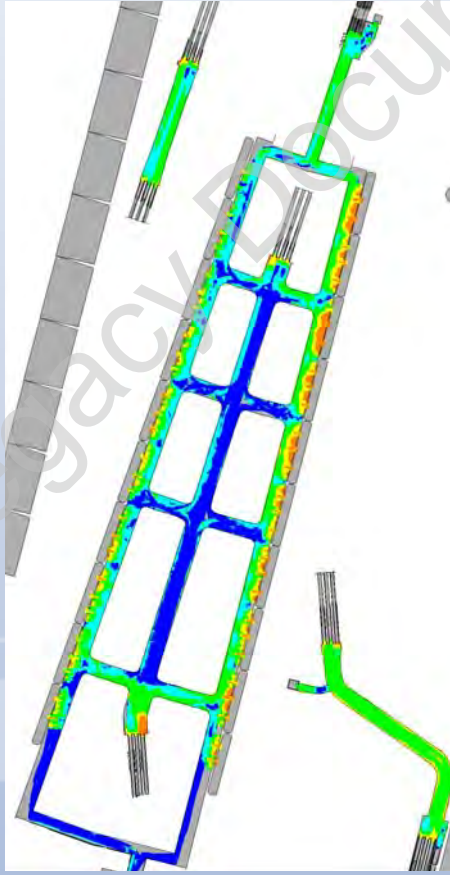
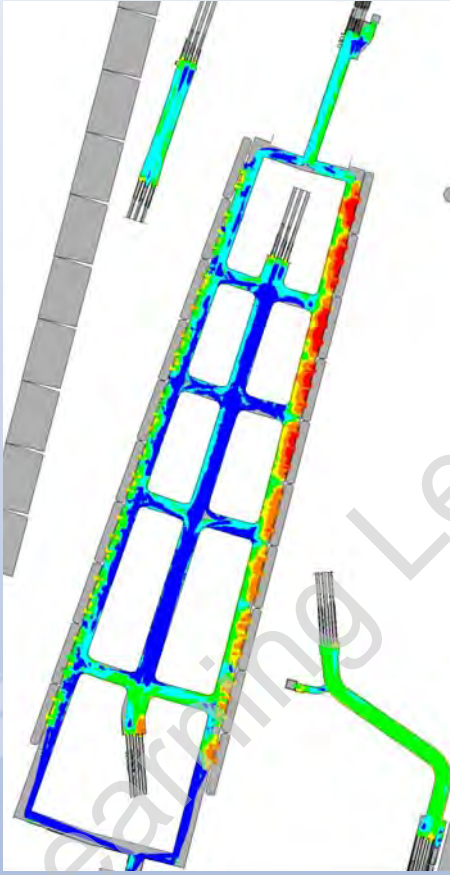
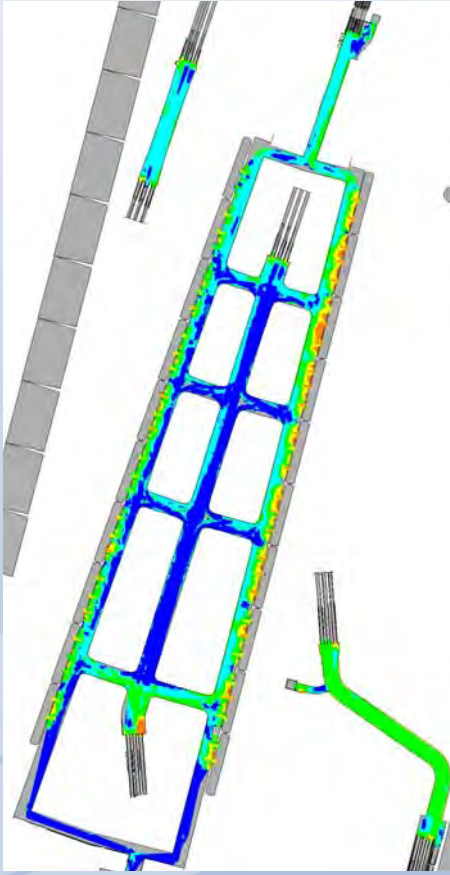

CMD - Walkway LOS (18:00-18:15)

Escalator travel direction ↓ Down ↑

Crossrail Platforms and Passageways AP2 and AP9

2026

2026+28%

No Cancelled train

Cancelled train

No Cancelled train

Cancelled train

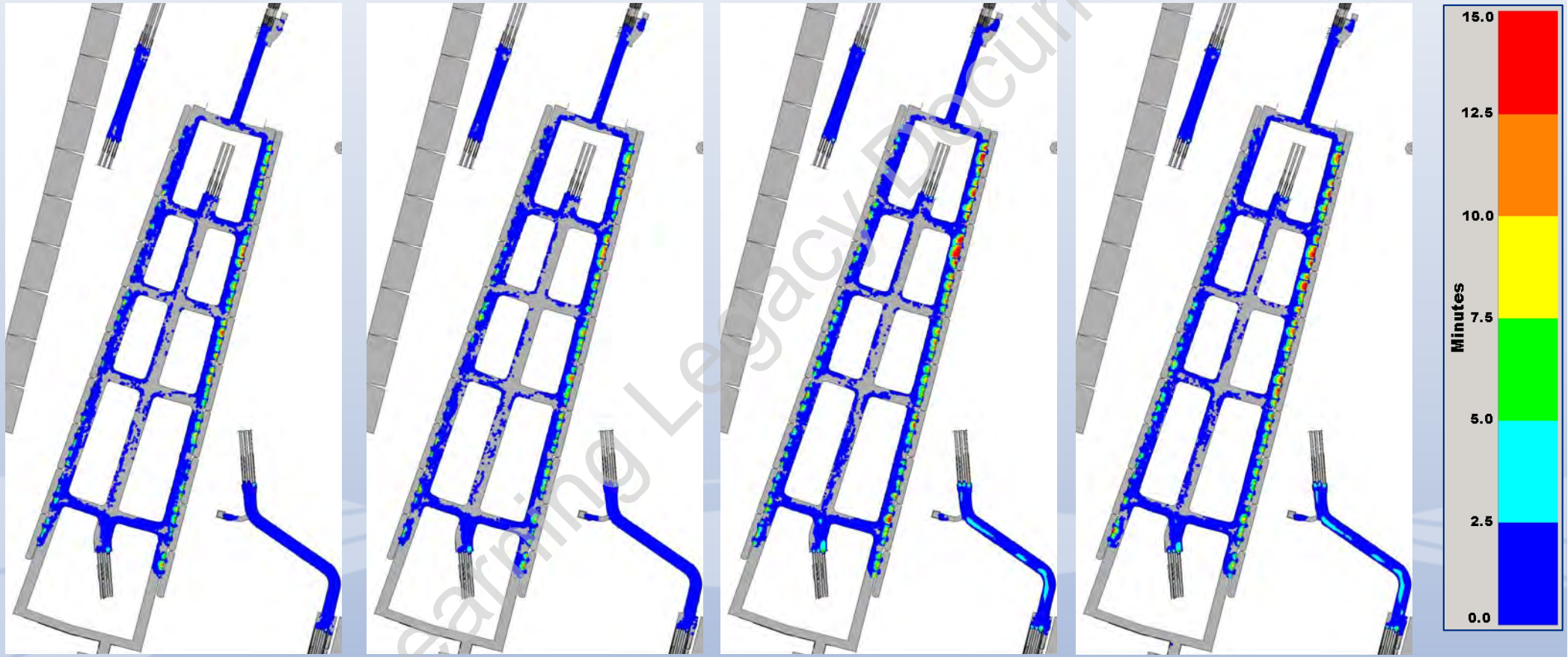

CHD - greater than Walkway LOS C (17:30-17:45)

Crossrail Platforms and Passageways AP2 and AP9

2026

No Cancelled train

Cancelled train

2026+28%

No Cancelled train

Cancelled train

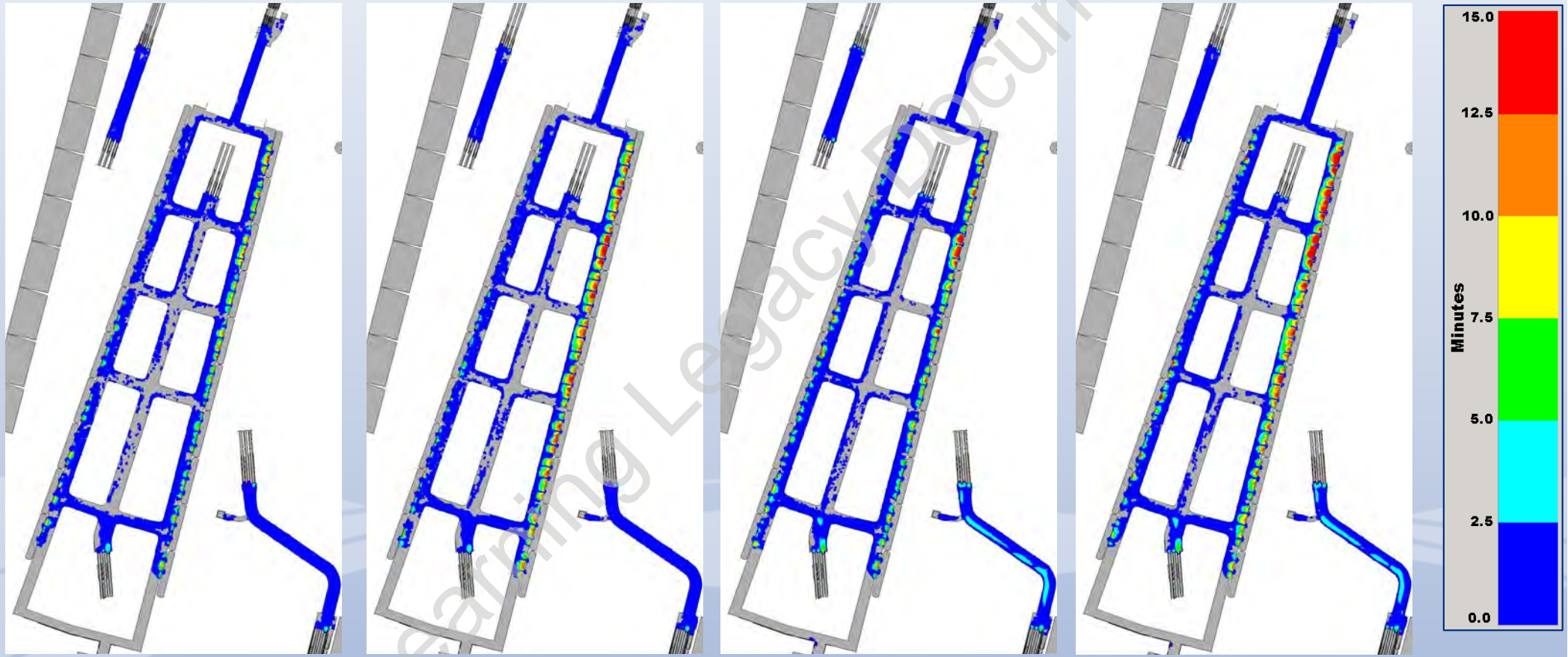

CHD - greater than Walkway LOS C (17:45-18:00)

Crossrail Platforms and Passageways AP2 and AP9

2026

No Cancelled train

Cancelled train

2026+28%

No Cancelled train

Cancelled train

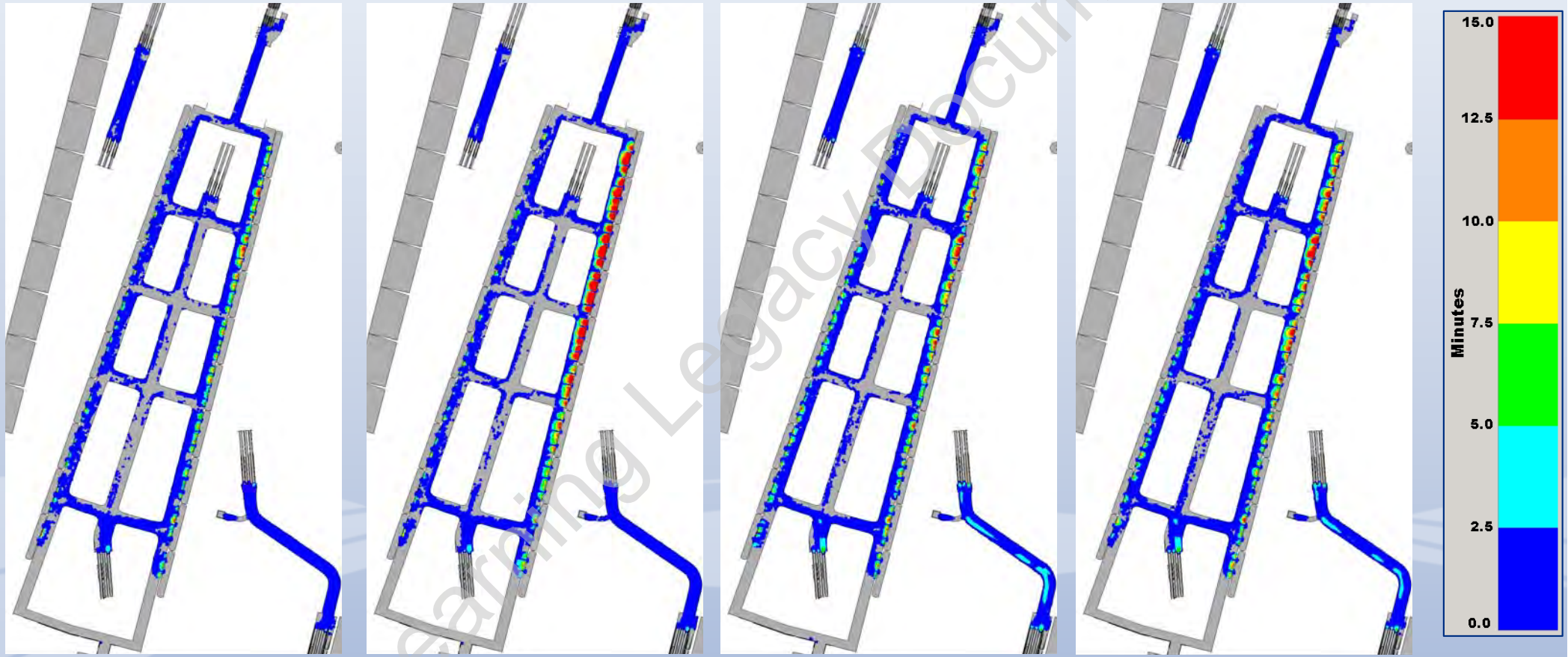

CHD - greater than Walkway LOS C (18:00-18:15)

Crossrail Platforms and Passageways AP2 and AP9

2026

No Cancelled train

Cancelled train

2026+28%

No Cancelled train

Cancelled train

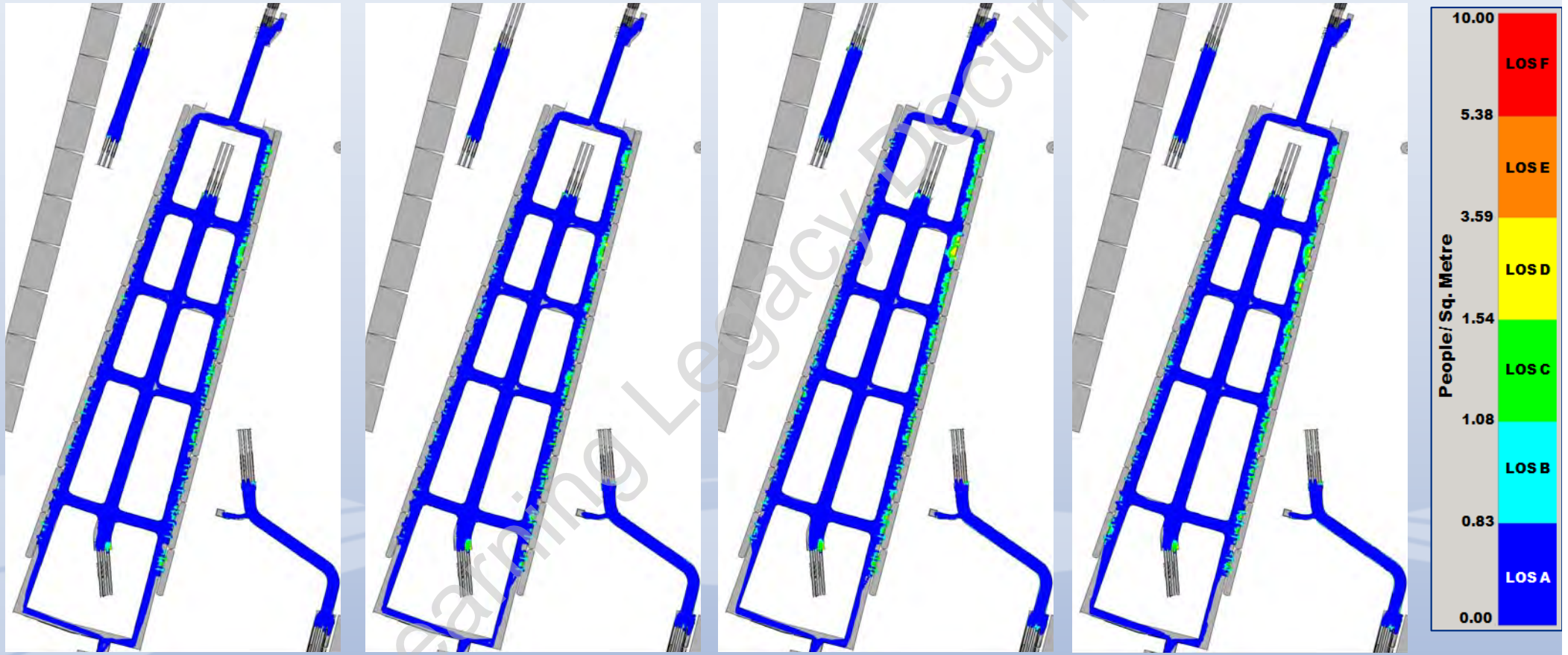

CMD - Queuing LOS (17:30-17:45)

Crossrail Platforms and Passageways AP2 and AP9

2026

No Cancelled train

Cancelled train

2026+28%

No Cancelled train

Cancelled train

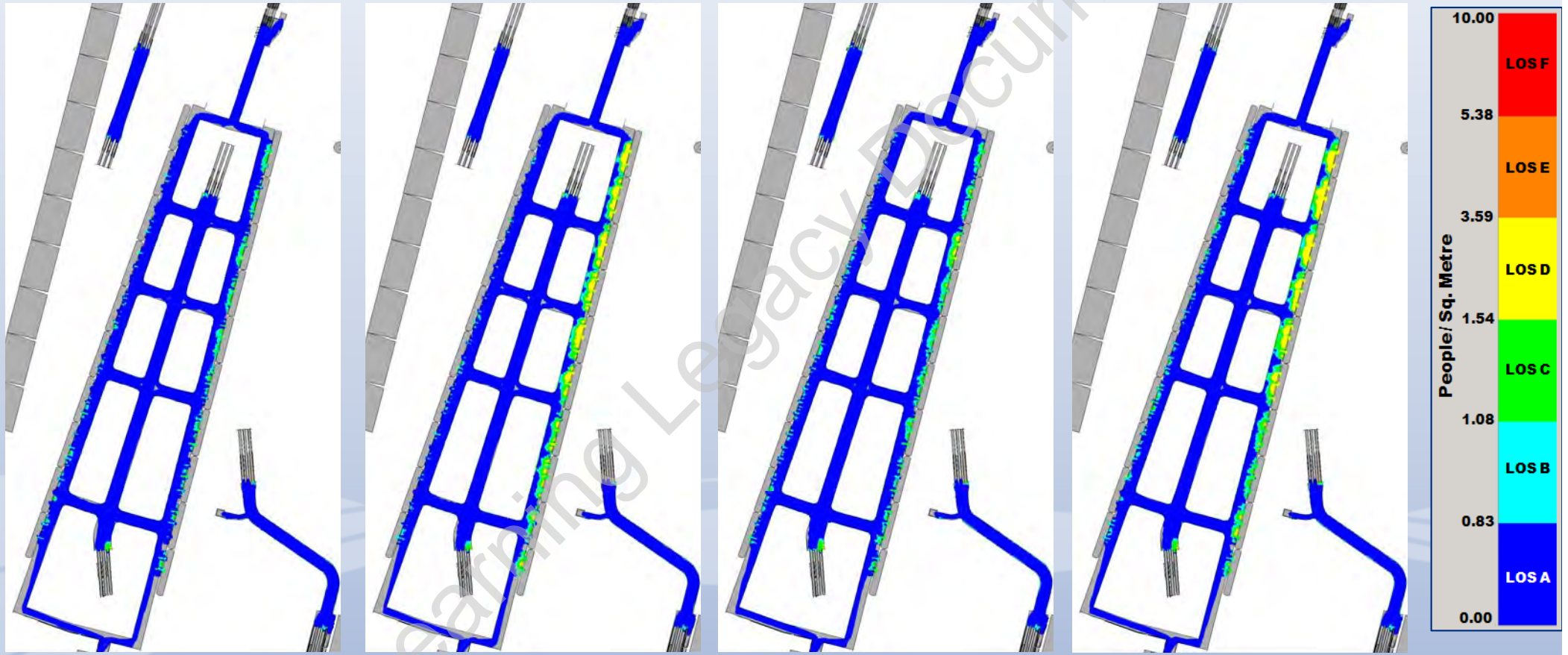

CMD - Queuing LOS (17:45-18:00)

Crossrail Platforms and Passageways AP2 and AP9



CMD - Queuing LOS (18:00-18:15)

Crossrail Platforms and Passageways AP2 and AP9



CHD - greater than Queuing LOS C (17:30-17:45)

Crossrail Platforms and Passageways AP2 and AP9



CHD - greater than Queuing LOS C (17:45-18:00)

Crossrail Platforms and Passageways AP2 and AP9



CHD - greater than Queuing LOS C (18:00-18:15)

PM – Scenario

Broadgate Ticket Hall and Liverpool Street Ticket Hall B

Broadgate Ticket Hall and Liverpool Street Ticket Hall B

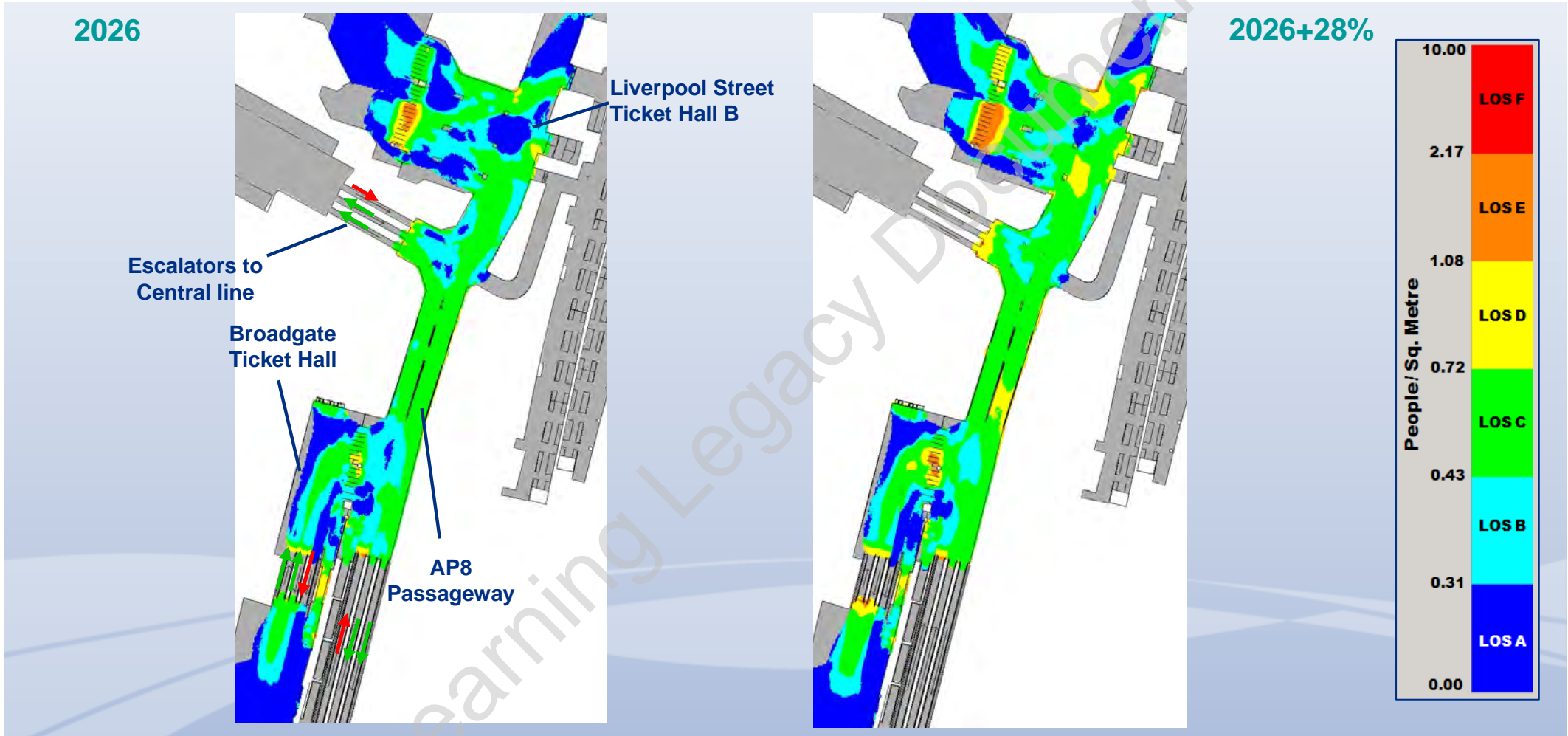

CMD - Walkway LOS (17:45-18:00)

Escalator travel direction ↓ Down ↑

Broadgate Ticket Hall and Liverpool Street Ticket Hall B

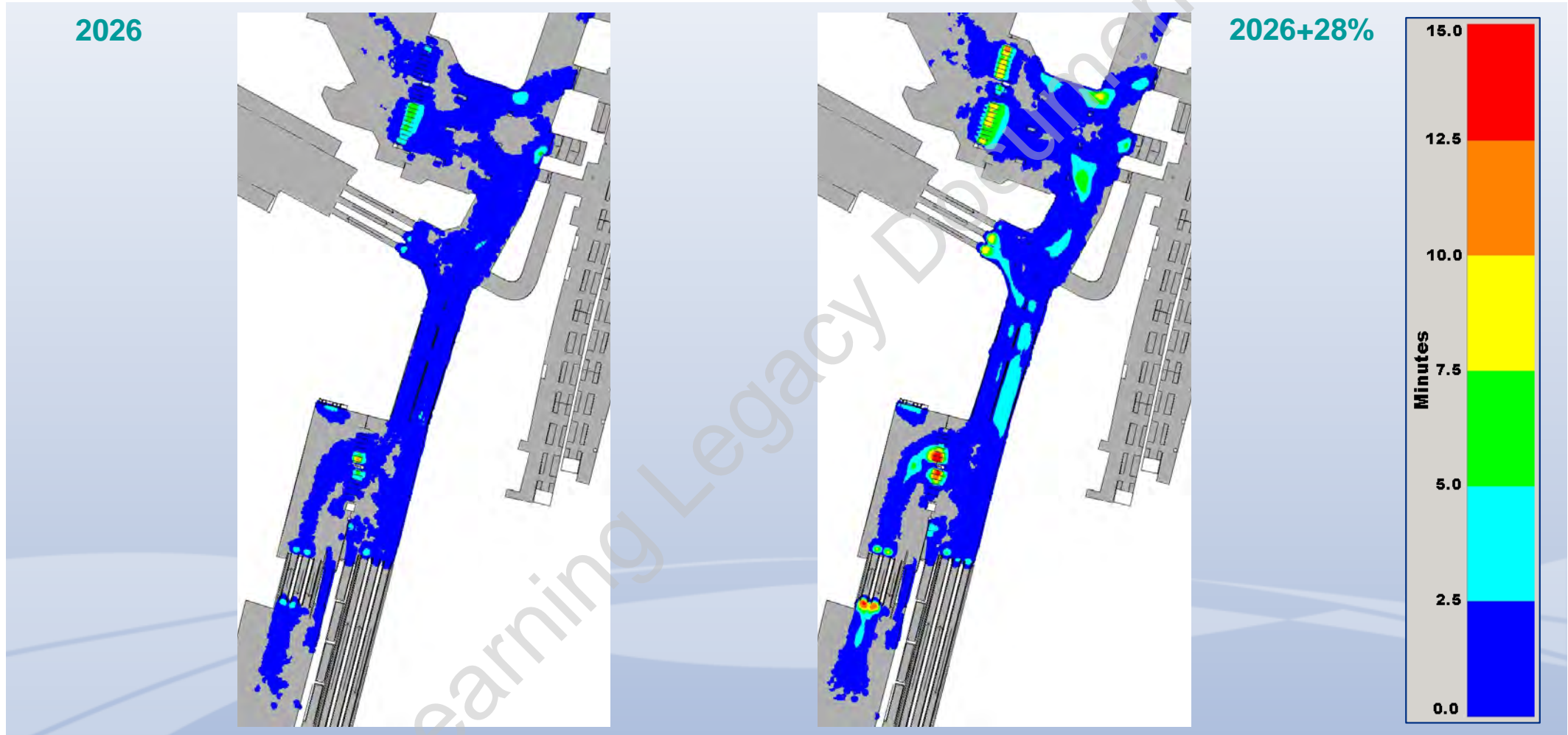

CHD - greater than Walkway LOS C (17:45-18:00)

Broadgate Ticket Hall and Liverpool Street Ticket Hall B

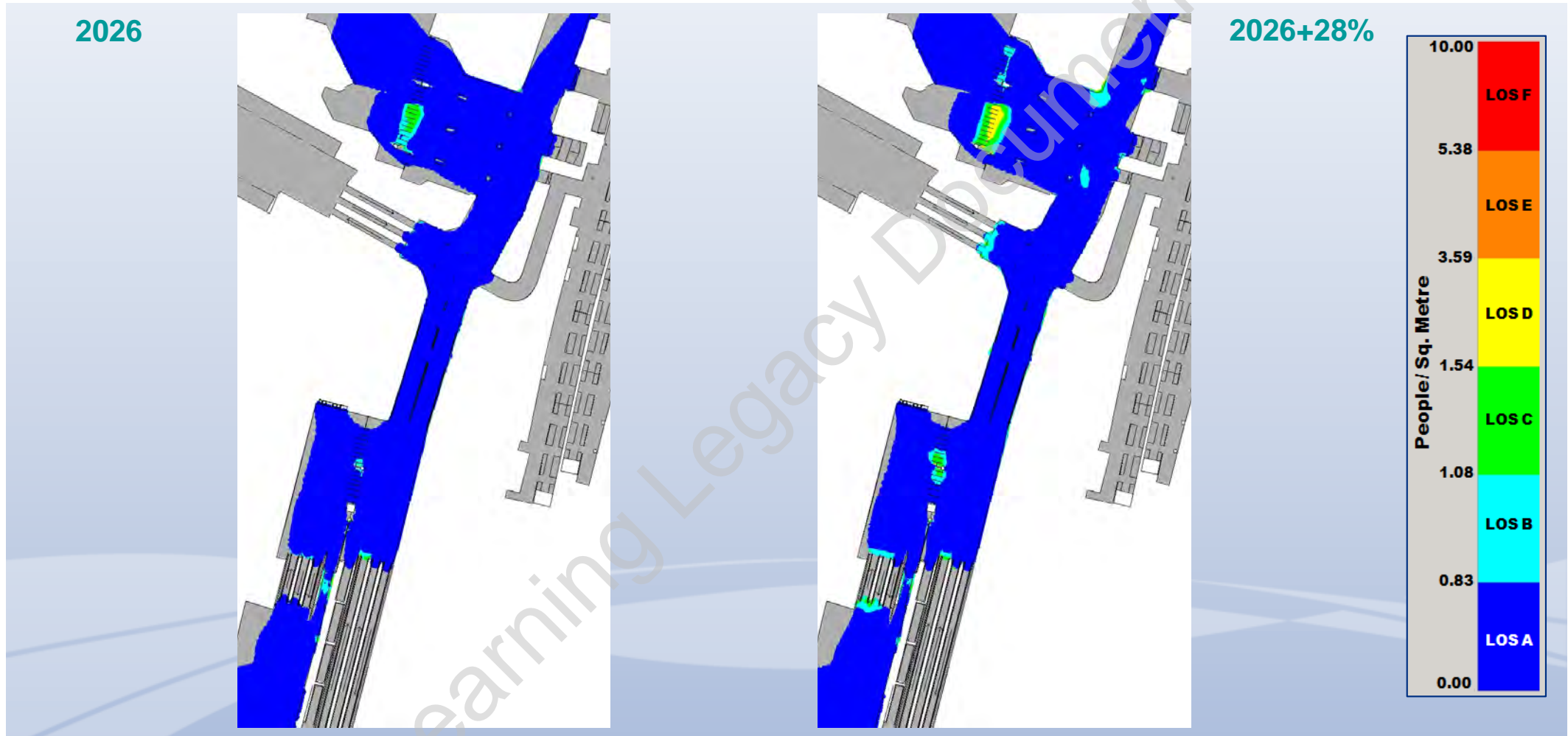

CMD - Queuing LOS (17:45-18:00)

Broadgate Ticket Hall and Liverpool Street Ticket Hall B

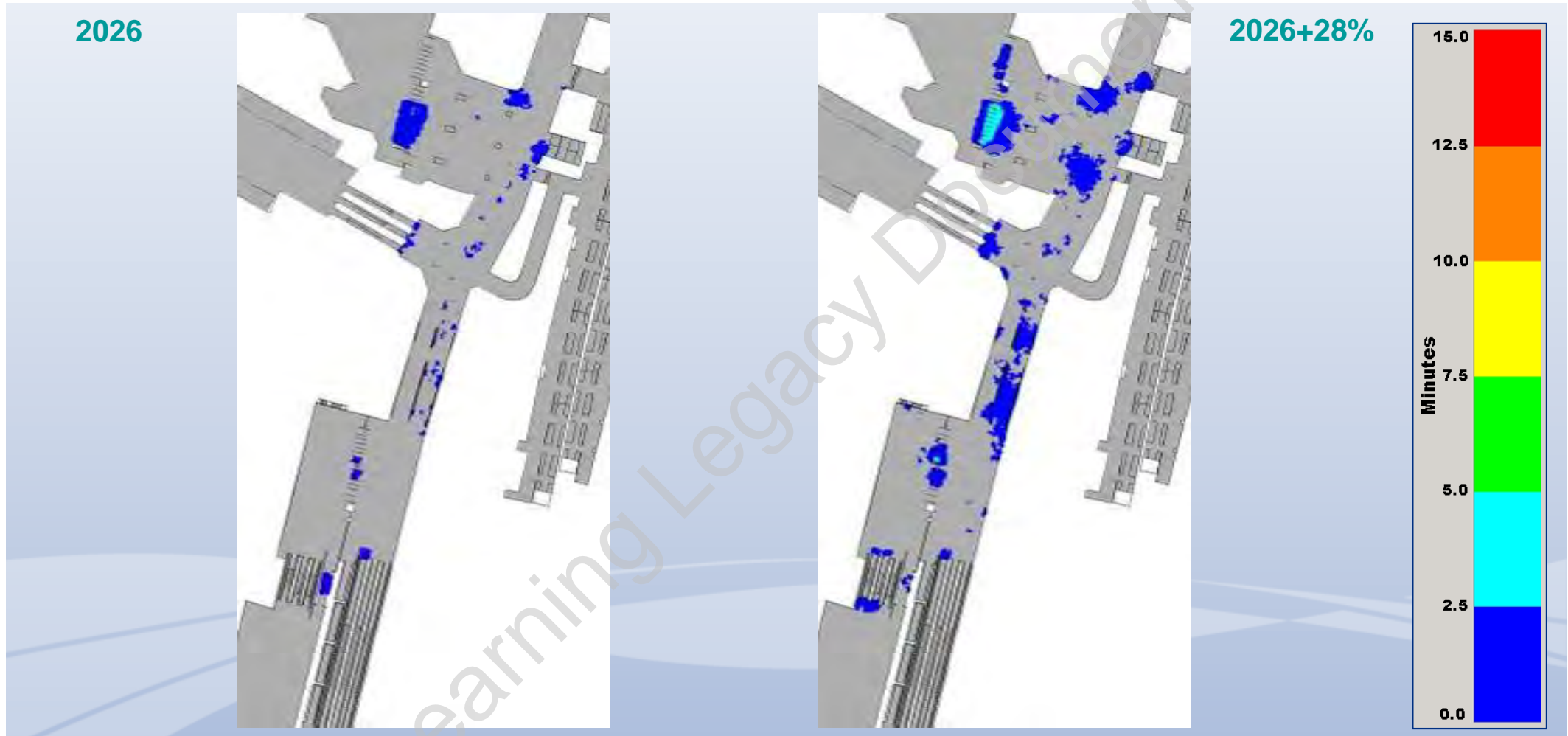

CHD - greater than Queuing LOS C (17:45-18:00)

2026 Demand Year Summary

Without Cancelled Train

| ID | Location | Description | No Cancelled Train | | | | | |
|----|---|---|--------------------|-------------|-------------|--------------|-------------|-------------|
| | | | AM Peak 2026 | | | PM Peak 2026 | | |
| | | | 08:30-08:45 | 08:45-09:00 | 09:00-09:15 | 17:30-17:45 | 17:45-18:00 | 18:00-18:15 |
| 1 | Moorgate Integrated ticket hall | Paid side | | Pass | | | Pass | |
| 2 | | Stairs to Metropolitan Line westbound ** | | Pass | | | Pass | |
| 3 | | Stairs to Metropolitan Line eastbound ** | | Fail* | | | Pass | |
| 4 | Northern Line Link | Passageways AP5 and AP6 | | Pass | | | Pass | |
| 5 | | Stairs and adit linking the NLL (AP6) and existing Northern Line platforms ** | | Fail* | | | Pass | |
| 6 | Existing Northern Line | Platforms | | Fail* | | | Pass | |
| 7 | Existing Northern Moorgate ticket hall | Paid side | | Pass | | | Pass | |
| 8 | Existing FCC | Platforms | | Fail | | | Fail | |
| 9 | Crossrail | Eastbound platform | Pass | Pass | Pass | Pass | Pass | Pass |
| 10 | | Westbound platform | Pass | Pass | Pass | Pass | Pass | Pass |
| 11 | | Central concourse | Pass | Pass | Pass | Pass | Pass | Pass |
| 12 | | Cross passage CP4 (Moorgate end) | Pass | Pass | Pass | Pass | Pass | Pass |
| 13 | | Cross passage CP3 (Moorgate end) | Pass | Pass | Pass | Pass | Pass | Pass |
| 14 | | Cross passage CP4a (Moorgate end) | Pass | Pass | Pass | Pass | Pass | Pass |
| 15 | | Cross passage CP3a (Moorgate end) | Pass | Pass | Pass | Pass | Pass | Pass |
| 16 | | Cross passage CP8 (Broadgate end) | Pass | Pass | Pass | Pass | Pass | Pass |
| 17 | | Cross passage CP7 (Broadgate end) | Pass | Pass | Pass | Pass | Pass | Pass |
| 18 | | Cross passage CP6 (Broadgate end) | Pass | Pass | Pass | Pass | Pass | Pass |
| 19 | | Cross passage CP5 (Broadgate end) | Pass | Pass | Pass | Pass | Pass | Pass |
| 20 | Cross passage CP1 (Northern Line Link) | Pass | Pass | Pass | Pass | Pass | Pass | |
| 21 | Cross passage CP2 (Northern Line Link) | Pass | Pass | Pass | Pass | Pass | Pass | |
| 22 | Passageway AP9 | Passageway between Crossrail platforms and Moorgate combined ticket hall | Pass | Pass | Pass | Pass | Pass | Pass |
| 23 | Passageway AP2 | Passageway between Crossrail platforms and Broadgate ticket hall | Pass | Pass | Pass | Pass | Pass | Pass |
| 24 | Broadgate ticket hall | Unpaid side | | Pass | | | Pass | |
| 25 | | Paid side | | Pass | | | Pass | |
| 26 | Existing Liverpool Street ticket hall B | Paid side | | Pass | | | Pass | |
| 27 | | Head of escalators leading to the Central line platforms | | Pass | | | Pass | |
| 28 | Passageway AP8 | Passageway between Broadgate ticket hall and Liverpool Street ticket hall B | | Pass | | | Pass | |

Key (Green) - Pass. Congestion and/or flow rates are acceptable

(Red) - Failure due to high levels of congestion or flow rates which are significantly above the acceptance criteria

* (Red) - Failure due to levels of congestion or flow rates being marginally above the acceptance criteria

** (Blue) Based on appraisal of average peak minute flow data extracted from dynamic Legion modelling outputs

2026+28% Sensitivity Scenarios Summary

Without Cancelled Train

| ID | Location | Description | No Cancelled Train | | | | | |
|----|---|---|--------------------|-------------|-------------|------------------|-------------|-------------|
| | | | AM Peak 2026+28% | | | PM Peak 2026+28% | | |
| | | | 08:30-08:45 | 08:45-09:00 | 09:00-09:15 | 17:30-17:45 | 17:45-18:00 | 18:00-18:15 |
| 1 | Moorgate Integrated ticket hall | Paid side | | Pass | | | Pass | |
| 2 | | Stairs to Metropolitan Line westbound ** | | Pass | | | Fail* | |
| 3 | | Stairs to Metropolitan Line eastbound ** | | Fail | | | Pass | |
| 4 | Northern Line Link | Passageways AP5 and AP6 | | Pass | | | Pass | |
| 5 | | Stairs and adit linking the NLL (AP6) and existing Northern Line platforms ** | | Fail | | | Fail* | |
| 6 | Existing Northern Line | Platforms | | Fail* | | | Pass | |
| 7 | Existing Northern Moorgate ticket hall | Paid side | | Fail* | | | Pass | |
| 8 | Existing FCC | Platforms | | Fail | | | Fail* | |
| 9 | Crossrail | Eastbound platform | Pass | Pass | Pass | Pass | Pass | Pass |
| 10 | | Westbound platform | Pass | Pass | Pass | Pass | Pass | Pass |
| 11 | | Central concourse | Pass | Pass | Pass | Pass | Pass | Pass |
| 12 | | Cross passage CP4 (Moorgate end) | Pass | Pass | Pass | Pass | Pass | Pass |
| 13 | | Cross passage CP3 (Moorgate end) | Pass | Pass | Pass | Pass | Pass | Pass |
| 14 | | Cross passage CP4a (Moorgate end) | Pass | Pass | Pass | Pass | Pass | Pass |
| 15 | | Cross passage CP3a (Moorgate end) | Pass | Pass | Pass | Pass | Pass | Pass |
| 16 | | Cross passage CP8 (Broadgate end) | Pass | Pass | Pass | Pass | Pass | Pass |
| 17 | | Cross passage CP7 (Broadgate end) | Pass | Pass | Pass | Pass | Pass | Pass |
| 18 | | Cross passage CP6 (Broadgate end) | Pass | Pass | Pass | Pass | Pass | Pass |
| 19 | | Cross passage CP5 (Broadgate end) | Pass | Pass | Pass | Pass | Pass | Pass |
| 20 | | Cross passage CP1 (Northern Line Link) | Pass | Pass | Pass | Pass | Pass | Pass |
| 21 | | Cross passage CP2 (Northern Line Link) | Pass | Pass | Pass | Pass | Pass | Pass |
| 22 | Passageway AP9 | Passageway between Crossrail platforms and Moorgate combined ticket hall | Pass | Pass | Pass | Pass | Pass | Pass |
| 23 | Passageway AP2 | Passageway between Crossrail platforms and Broadgate ticket hall | Pass | Pass | Pass | Pass | Pass | Pass |
| 24 | Broadgate ticket hall | Unpaid side | | Pass | | | Pass | |
| 25 | | Paid side | | Pass | | | Pass | |
| 26 | Existing Liverpool Street ticket hall B | Paid side | | Fail* | | | Fail* | |
| 27 | | Head of escalators leading to the Central line platforms | | Pass | | | Pass | |
| 28 | Passageway AP8 | Passageway between Broadgate ticket hall and Liverpool Street ticket hall B | | Fail* | | | Fail* | |

- Key**
- (Green) - Pass. Congestion and/or flow rates are acceptable
 - (Red) - Failure due to high levels of congestion or flow rates which are significantly above the acceptance criteria
 - * (Red) - Failure due to levels of congestion or flow rates being marginally above the acceptance criteria
 - ** (Blue) Based on appraisal of average peak minute flow data extracted from dynamic Legion modelling outputs

2026 and 2026+28% Sensitivity Scenarios Summary

With Cancelled Train

| ID | Location | Description | Cancelled Train | | | | | |
|----|--|--|-----------------|-------------|-------------|------------------|-------------|-------------|
| | | | PM Peak 2026 | | | PM Peak 2026+28% | | |
| | | | 17:30-17:45 | 17:45-18:00 | 18:00-18:15 | 17:30-17:45 | 17:45-18:00 | 18:00-18:15 |
| 9 | Crossrail | Eastbound platform | Pass | Fail | Fail | Pass | Fail | Fail |
| 10 | | Westbound platform | Pass | Pass | Pass | Pass | Pass | Pass |
| 11 | | Central concourse | Pass | Pass | Pass | Pass | Pass | Pass |
| 12 | | Cross passage CP4 (Moorgate end) | Pass | Pass | Pass | Pass | Pass | Pass |
| 13 | | Cross passage CP3 (Moorgate end) | Pass | Pass | Pass | Pass | Pass | Pass |
| 14 | | Cross passage CP4a (Moorgate end) | Pass | Pass | Pass | Pass | Pass | Pass |
| 15 | | Cross passage CP3a (Moorgate end) | Pass | Pass | Pass | Pass | Pass | Pass |
| 16 | | Cross passage CP8 (Broadgate end) | Pass | Pass | Pass | Pass | Pass | Pass |
| 17 | | Cross passage CP7 (Broadgate end) | Pass | Pass | Pass | Pass | Pass | Pass |
| 18 | | Cross passage CP6 (Broadgate end) | Pass | Pass | Pass | Pass | Pass | Pass |
| 19 | | Cross passage CP5 (Broadgate end) | Pass | Pass | Pass | Pass | Pass | Pass |
| 20 | | Cross passage CP1 (Northern Line Link) | Pass | Pass | Pass | Pass | Pass | Pass |
| 21 | Cross passage CP2 (Northern Line Link) | Pass | Pass | Pass | Pass | Pass | Pass | |
| 22 | Passageway AP9 | Passageway between Crossrail platforms and Moorgate combined ticket hall | Pass | Pass | Pass | Pass | Pass | Pass |
| 23 | Passageway AP2 | Passageway between Crossrail platforms and Broadgate ticket hall | Pass | Pass | Pass | Pass | Pass | Pass |

Key (Green) - Pass. Congestion and/or flow rates are acceptable
 (Red) - Failure due to high levels of congestion or flow rates which are significantly above the acceptance criteria
 * (Red) - Failure due to levels of congestion or flow rates being marginally above the acceptance criteria
 ** (Blue) Based on appraisal of average peak minute flow data extracted from dynamic Legion modelling outputs

Document control Sheet

| Project title: | C138 Liverpool Street Station | | |
|--------------------------|---|--------------|-------------------|
| MM project number: | 266429 | | |
| Document type: | Report | | |
| Directory & file name: | http://pims01/pims/llisapi.dll/Open/1469988665 | | |
| Document Approval | | | |
| Primary author: | Ewa Prawdzik | | |
| Other author(s): | | | |
| Reviewer(s): | Sonja Le Bail | | |
| Formatted by: | Ewa Prawdzik | | |
| Distribution | | | |
| Issue | Date | Distribution | Comments |
| 2.0 | 25/10/2011 | Crossrail | Issue for review. |



Appendix E: Dynamic Passenger Modelling Output – Station Management

Learning Legacy Document



C138: Liverpool Street Station

Management Strategy for E/B Crossrail Boarders

Scope and Purpose

- A suite of sensitivity analyses has been undertaken to evaluate the 2026, 2026+7%, 2026+14% and 2026+21% demand years in relation to the following two operational scenarios (see following slides):
 - Without management of E/B boarders
 - With management of E/B boarders (MS1 and MS2)
- Each sensitivity test assumes a perturbed train service (i.e. cancelled eastbound train during the peak 15 minutes), and 24 Crossrail trains per hour.
- The aim of this analysis is to assess the impact of introducing active management of the platform and adits.

Model Configuration

[Redacted]
[Redacted]

Passenger Routing – Base Model Assumptions

- The figure below shows the base model routing assumption for Crossrail passengers. In this strategy, 85% of the passengers use the first adit (from Moorgate escalators) to access the platform, and 15% use the second adit.

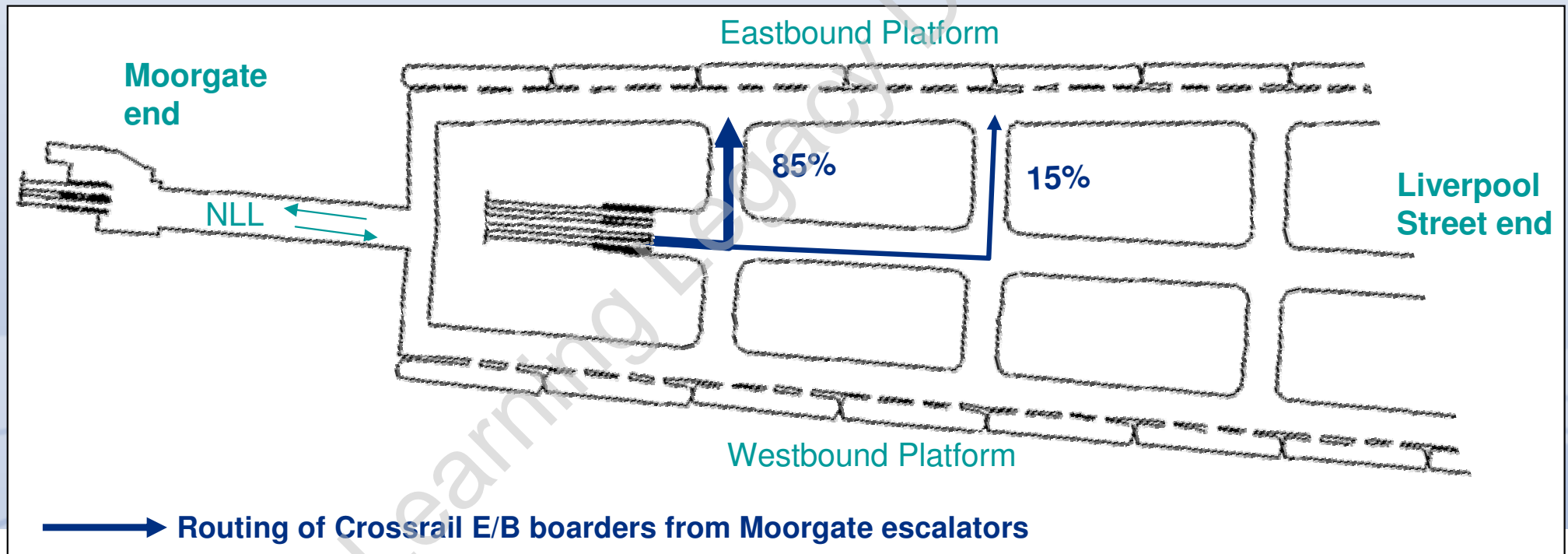

Passenger Routing – Post LU Audit Management Assumptions

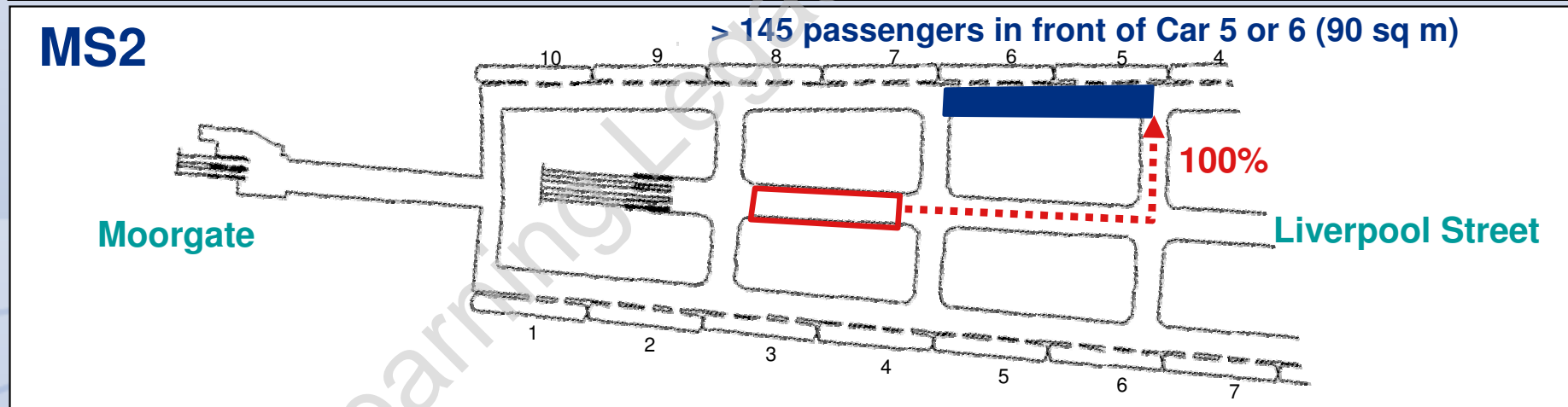
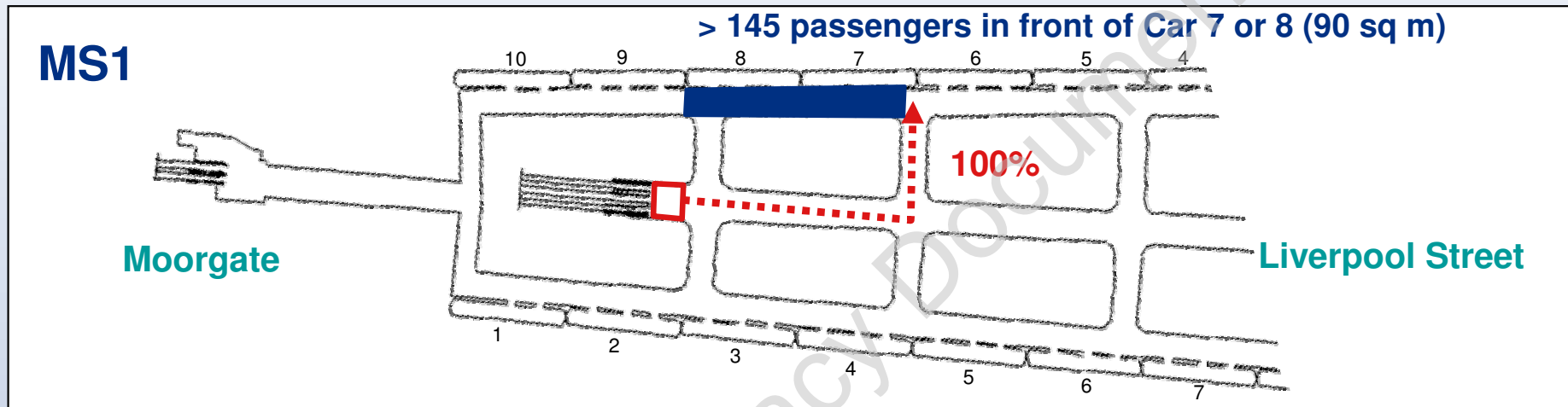

■ Observation area for level of congestion

.....➔ Redirected E/B boarders via 2nd / 3rd adit

Results and Outputs

[Redacted]
[Redacted]

Legion Models

- The final models developed by the FDC, which have been used to undertake this present study are:
 - 2026 PM peak
 - No Management: LIV 2026 1715-1845 PM PRM lift no MS v04.lgm
 - With Management: LIV 2026 1715-1845 PM PRM lift v05.lgm
 - 2026+7% PM peak
 - No Management: LIV 2026+07% 1715-1845 PM PRM lift simple no MS v05.lgm
 - With Management: LIV 2026+07% 1715-1845 PM PRM lift simple v08.lgm
 - 2026+14% PM peak
 - No Management : LIV 2026+14% 1715-1845 PM PRM lift simple no MS v06.lgm
 - With Management : LIV 2026+14% 1715-1845 PM PRM lift simple v07.lgm
 - 2026+21% PM peak
 - With Management : LIV 2026+21% 1715-1845 PM PRM lift simple v08.lgm

Maximum Passenger Load and Density Analysis

| | 2026 | | | | 2026+7% | | | |
|-----------------|--|---|--|---|--|---|--|---|
| | No Management | | Managed | | No Management | | Managed | |
| | Max platform load (boarders + alighters) | Equivalent density for 4.5m (p/m ²) | Max platform load (boarders + alighters) | Equivalent density for 4.5m (p/m ²) | Max platform load (boarders + alighters) | Equivalent density for 4.5m (p/m ²) | Max platform load (boarders + alighters) | Equivalent density for 4.5m (p/m ²) |
| Car 1 | 64 | 0.71 | 78 | 0.87 | 67 | 0.74 | 88 | 0.98 |
| Car 2 | 80 | 0.89 | 114 | 1.27 | 107 | 1.19 | 116 | 1.29 |
| Car 3 | 109 | 1.21 | 133 | 1.48 | 118 | 1.31 | 165 | 1.83 |
| Car 4 | 134 | 1.49 | 161 | 1.79 | 159 | 1.77 | 197 | 2.19 |
| Car 5 | 154 | 1.71 | 171 | 1.90 | 184 | 2.04 | 141 | 1.57 |
| Car 6 | 188 | 2.09 | 165 | 1.83 | 207 | 2.30 | 183 | 2.03 |
| Car 7 | 176 | 1.96 | 141 | 1.57 | 184 | 2.04 | 156 | 1.73 |
| Car 8 | 211 | 2.34 | 155 | 1.72 | 259 | 2.88 | 167 | 1.86 |
| Car 9 | 184 | 2.04 | 154 | 1.71 | 201 | 2.23 | 166 | 1.84 |
| Car 10 | 139 | 1.54 | 128 | 1.42 | 121 | 1.34 | 135 | 1.50 |
| Platform | 1423 | 1.58 | 1380 | 1.53 | 1557 | 1.73 | 1496 | 1.66 |

 = Above 145 passengers next to a carriage, which is equivalent to a density of 1.62p/m².

Duration that Maximum Thresholds Exceeded

2026

No Management

Managed

| | Time above threshold (min) | | | Time above threshold (min) | | |
|--------|----------------------------|----------------|-----------------|----------------------------|----------------|-----------------|
| | 1.62 * p/m2 | 1.54 ^ p/m2 | 1.25 ^^ p/m2 | 1.62 * p/m2 | 1.54 ^ p/m2 | 1.25 ^^ p/m2 |
| Car 1 | 0.0 | 0.0 | 0.0 | 0.0 | 0.0 | 0.0 |
| Car 2 | 0.0 | 0.0 | 0.0 | 0.0 | 0.0 | 0.0 |
| Car 3 | 0.0 | 0.0 | 0.0 | 0.0 | 0.0 | 0.5 |
| Car 4 | 0.0 | 0.0 | 0.4 | 0.1 | 0.3 | 2.9 |
| Car 5 | 0.1 | 0.1 | 2.8 | 1.1 | 2.0 | 6.3 |
| Car 6 | 2.5 | 4.0 | 10.2 | 1.2 | 2.0 | 7.4 |
| Car 7 | 4.6 | 7.0 | 16.4 | 0.0 | 0.1 | 4.4 |
| Car 8 | 8.3 | 9.3 | 19.4 | 1.2 | 2.8 | 6.8 |
| Car 9 | 5.9 | 9.2 | 17.9 | 0.7 | 1.9 | 6.5 |
| Car 10 | 0.0 | 0.0 | 1.5 | 0.0 | 0.0 | 0.5 |

2026+7%

No Management

Managed

| | Time above threshold (min) | | | Time above threshold (min) | | |
|--------|----------------------------|----------------|-----------------|----------------------------|----------------|-----------------|
| | 1.62 * p/m2 | 1.54 ^ p/m2 | 1.25 ^^ p/m2 | 1.62 * p/m2 | 1.54 ^ p/m2 | 1.25 ^^ p/m2 |
| Car 1 | 0.0 | 0.0 | 0.0 | 0.0 | 0.0 | 0.0 |
| Car 2 | 0.0 | 0.0 | 0.0 | 0.0 | 0.0 | 0.1 |
| Car 3 | 0.0 | 0.0 | 0.1 | 0.7 | 1.4 | 6.0 |
| Car 4 | 0.1 | 0.1 | 1.8 | 3.4 | 4.7 | 8.8 |
| Car 5 | 1.3 | 1.9 | 9.8 | 0.0 | 0.0 | 2.8 |
| Car 6 | 10.8 | 13.9 | 21.7 | 3.5 | 6.5 | 18.2 |
| Car 7 | 2.7 | 5.3 | 20.4 | 0.1 | 0.7 | 6.8 |
| Car 8 | 39.6 | 41.2 | 47.0 | 3.8 | 7.7 | 17.8 |
| Car 9 | 14.9 | 18.7 | 28.6 | 4.9 | 5.7 | 18.8 |
| Car 10 | 0.0 | 0.0 | 1.1 | 0.0 | 0.0 | 4.5 |

* = Threshold at which management required

^ = Upper limit of platform density - Crossrail Station Platform Standard (CR-STD-305 v8.0)

^^ = Upper limit of platform density - LU - SPS (1-371-A4)

| | |
|---------|---------|
| Minutes | > 25 |
| | 20 - 25 |
| | 15 - 20 |
| | 10 - 15 |
| | 5 - 10 |
| | 0 - 5 |

Crossrail Platforms and Passageways AP2 and AP9 Modelling Output

- For each sensitivity test, the following Legion output maps are presented for the 2026 and 2026+7% PM peak period:
 - 17:30 – 17:45 (Walkway and Queuing CMD and CHD)
 - 17:45 – 18:00 (Walkway and Queuing CMD and CHD)
 - 18:00 - 18:15 (Walkway and Queuing CMD and CHD)
- The modelling output will also be shown for the following two operational scenarios:
 - Without management of E/B boarders
 - With management of E/B boarders (MS1 and MS2)

Assessment Criteria

- Based on the passenger modelling output, the operational performance of the station has been assessed against the criteria defined within the Crossrail Pedestrian Modelling Guidelines (CR/QMS/OPS/GN/0010). Accordingly, the guidelines refer to the LU - Station Planning Standard (1-371-A4), and / or the overarching Crossrail Station Planning Standard – Platforms (CR-STD-305, version 8.0). It requires that passenger density during the peak 15 minute period satisfies the following criteria:
 - Walkway Level of Service (LOS) C or better in the circulation areas.
 - Queuing Level of Service (LOS) C or better in queuing areas for ticket hall facilities, and waiting / accumulation areas for platforms.
 - Queuing Level of Service (LOS) B or better in open concourse areas.
- The Crossrail modelling guidelines state that a platform assessment should be predominantly based on the Queuing LOS, but where the predominant platform activity is movement Walkway LOS should be used (e.g. around an adit).

Crossrail Platforms and Passageways AP2 and AP9 2026 and 2026+7% Output

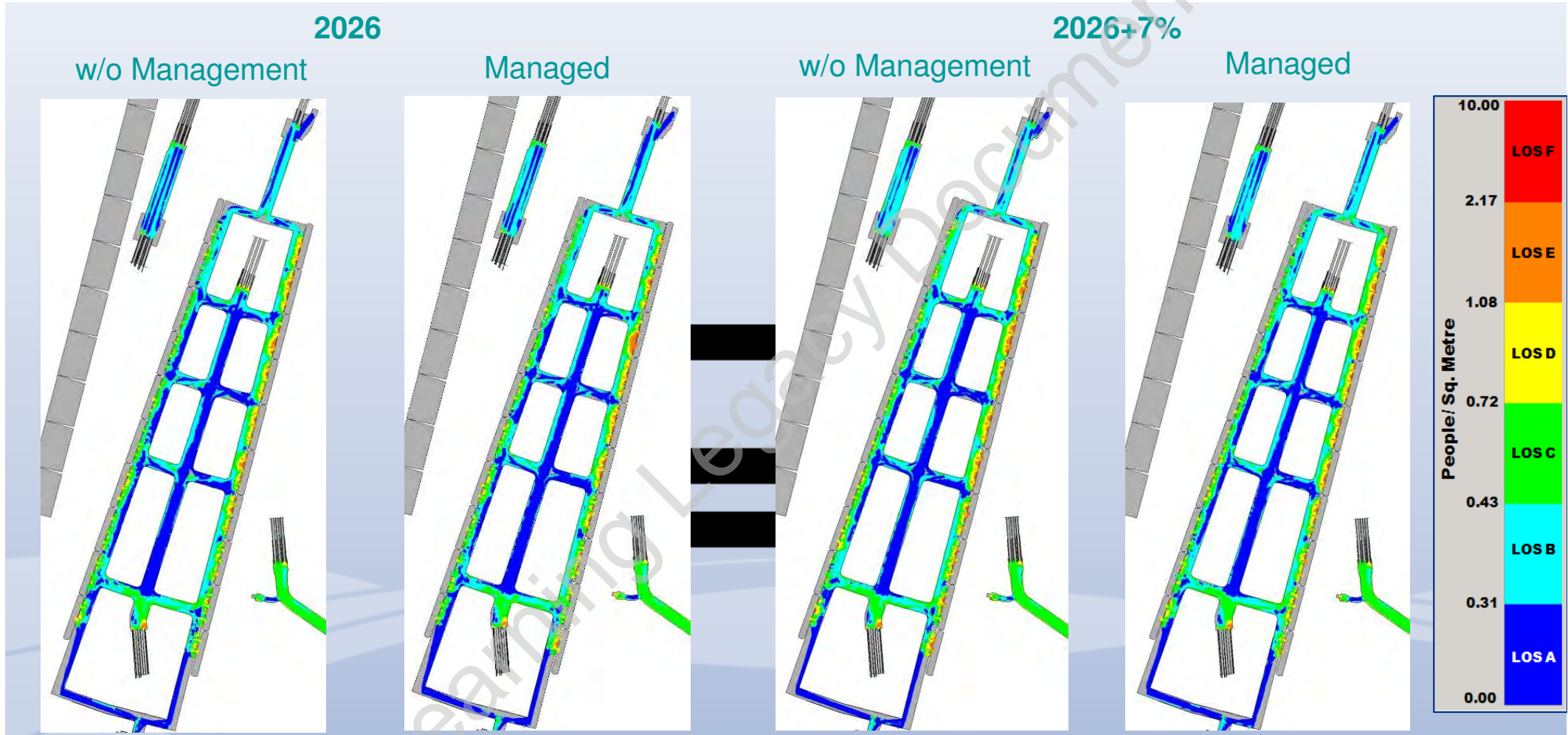

CMD - Walkway LOS (17:30 -17:45)

Crossrail Platforms and Passageways AP2 and AP9 2026 and 2026+7% Output

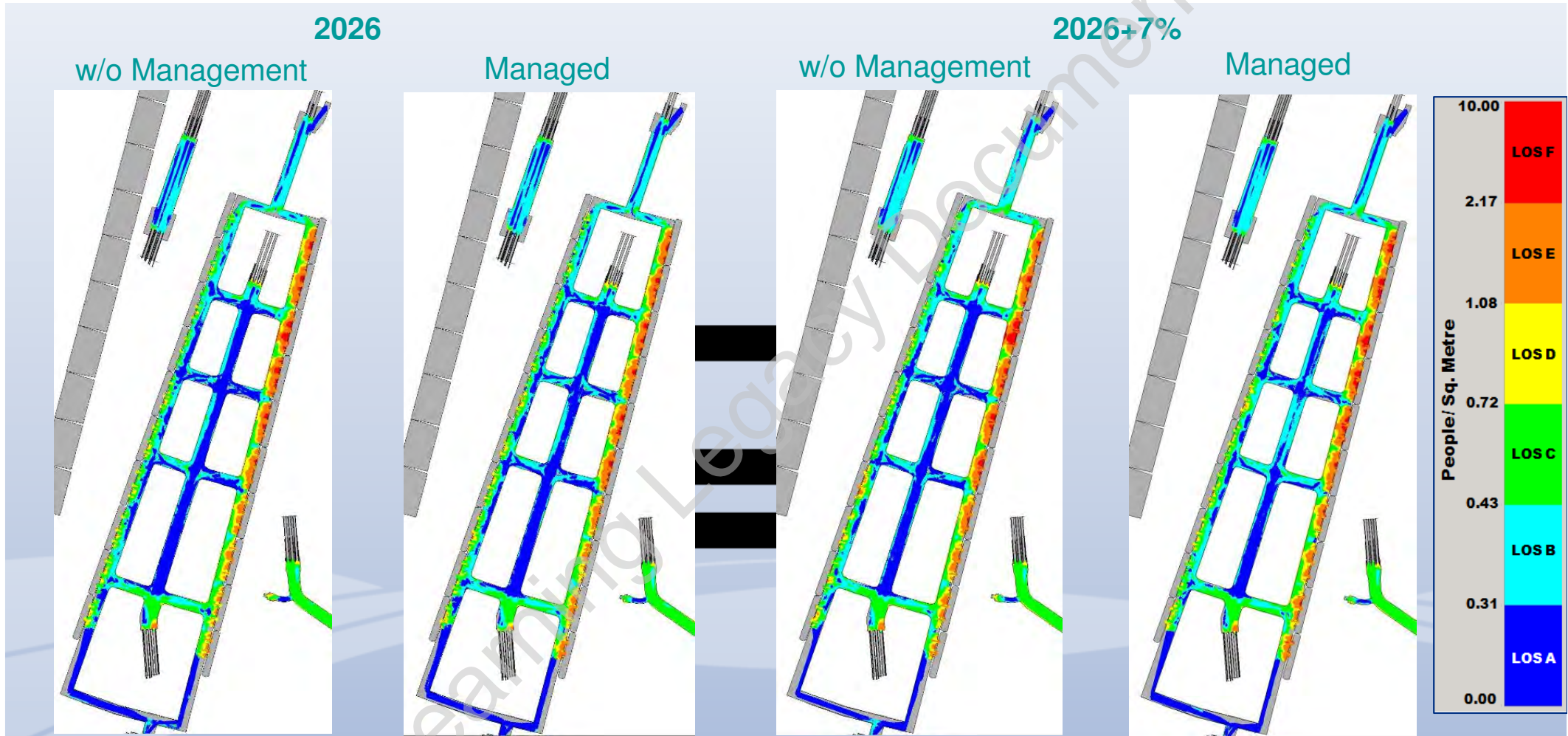

CMD - Walkway LOS (17:45-18:00)

Crossrail Platforms and Passageways AP2 and AP9 2026 and 2026+7% Output

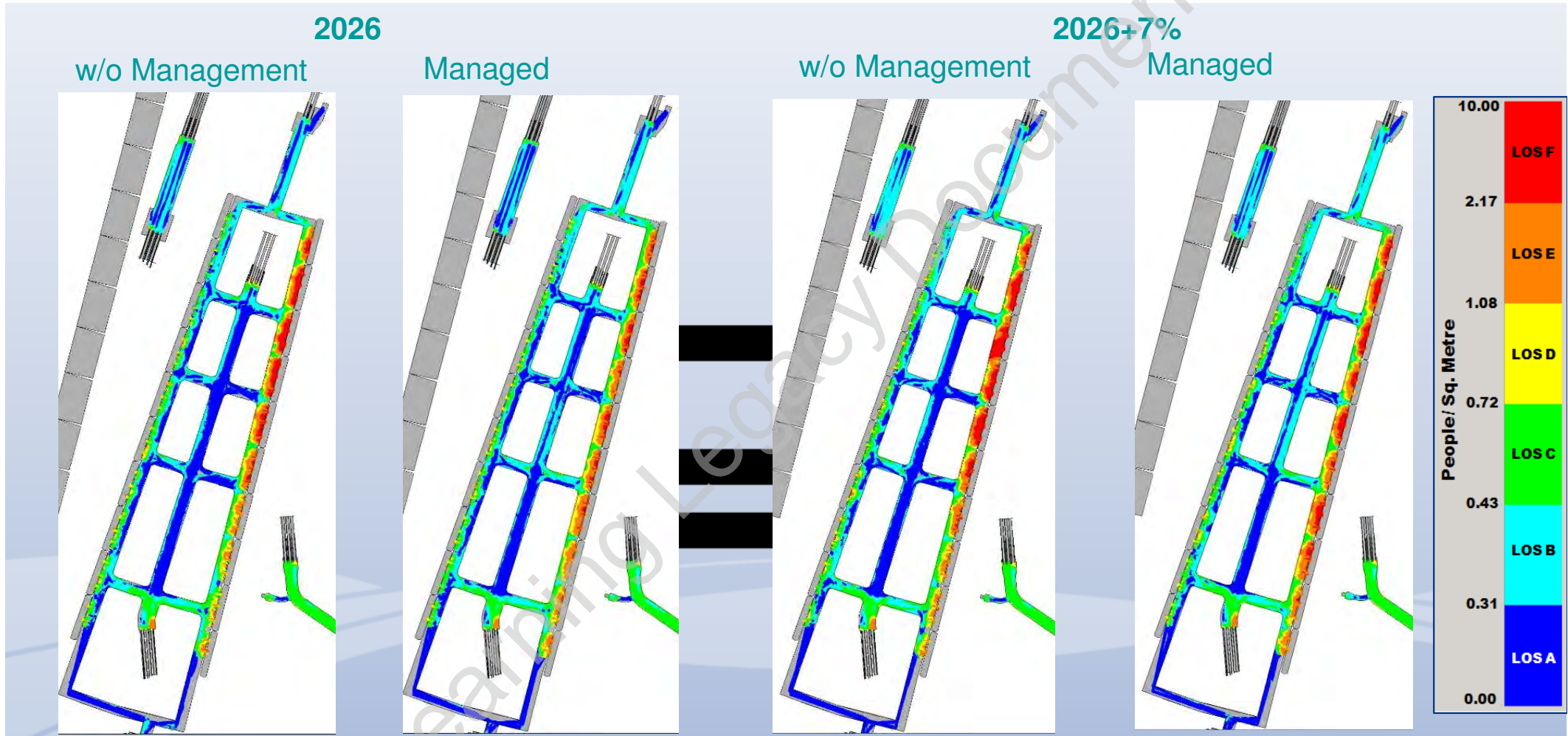

CMD - Walkway LOS (18:00 -18:15)

Crossrail Platforms and Passageways AP2 and AP9 2026 and 2026+7% Output

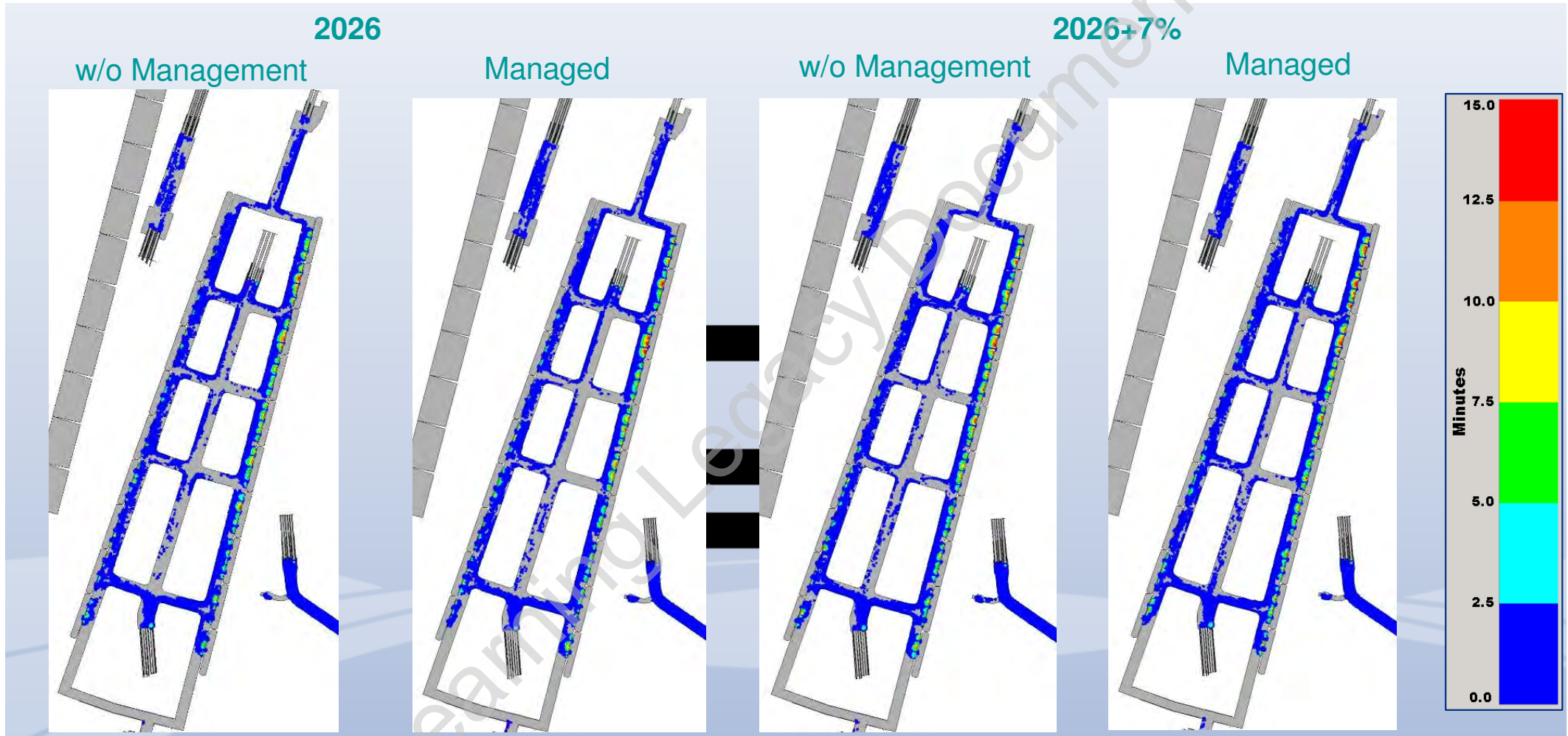

CHD - greater than Walkway LOS C (17:30 -17:45)

Crossrail Platforms and Passageways AP2 and AP9 2026 and 2026+7% Output

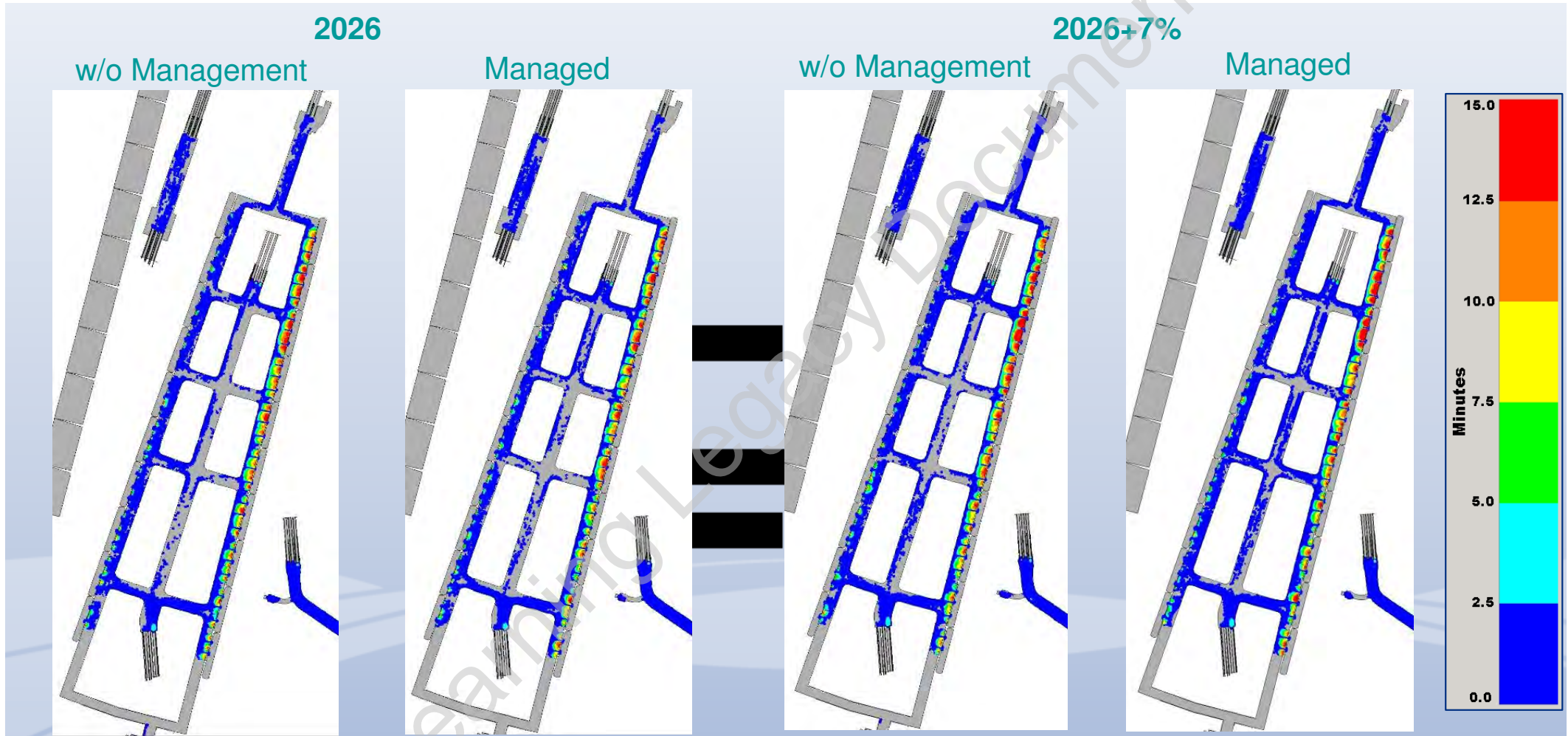

CHD - greater than Walkway LOS C (17:45-18:00)

Crossrail Platforms and Passageways AP2 and AP9 2026 and 2026+7% Output

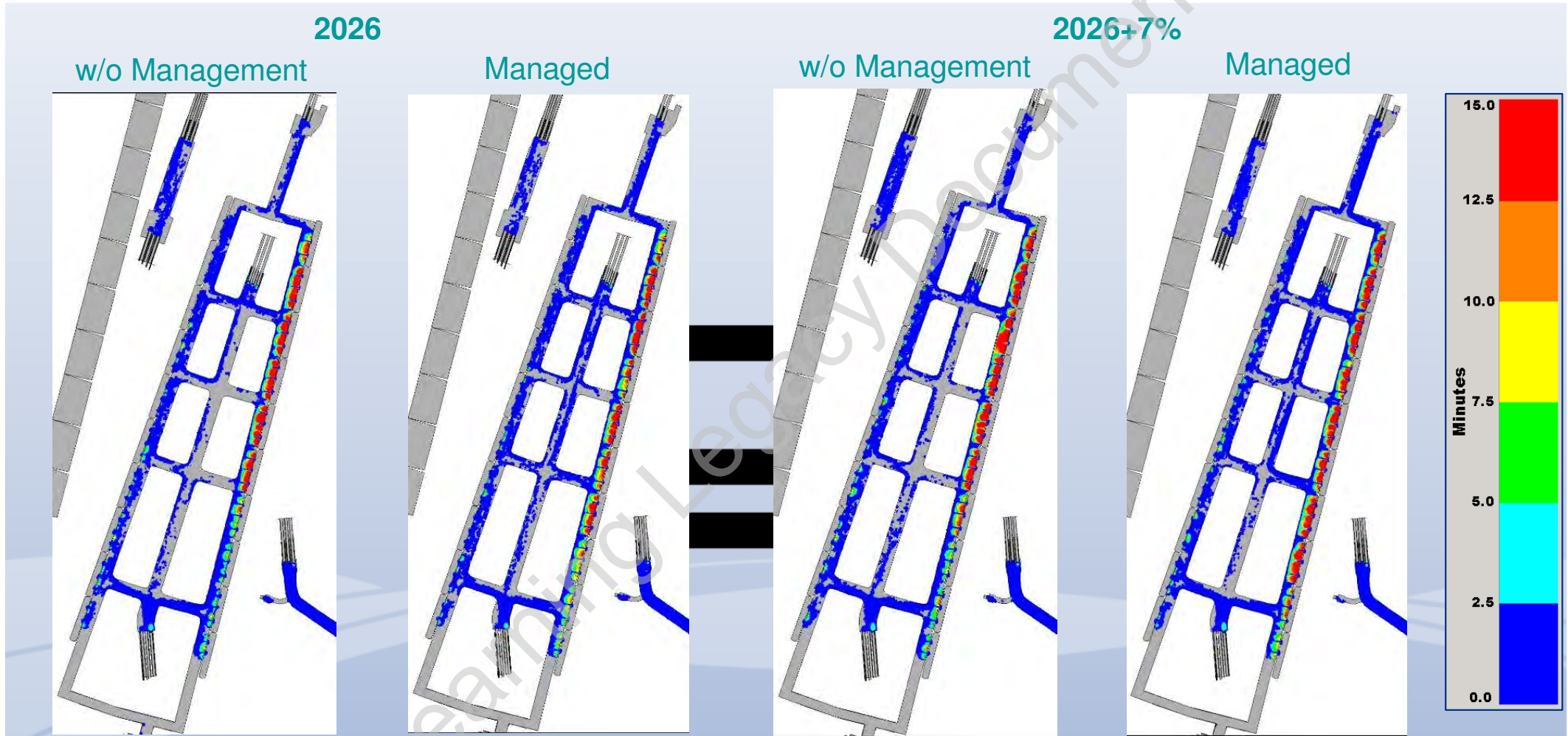

CHD - greater than Walkway LOS C (18:00 -18:15)

Crossrail Platforms and Passageways AP2 and AP9 2026 and 2026+7% Output

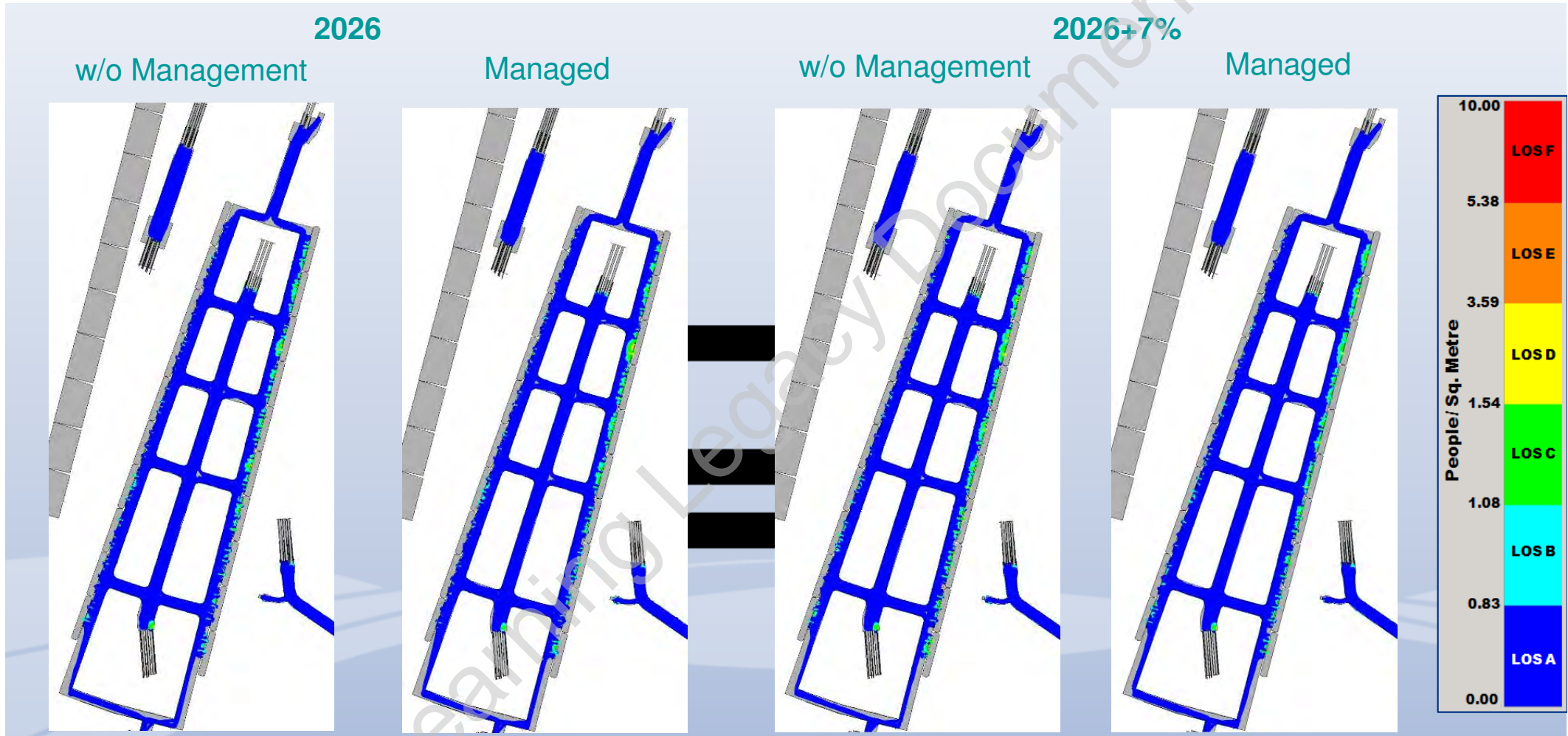

CMD - Queuing LOS (17:30 -17:45)

Crossrail Platforms and Passageways AP2 and AP9 2026 and 2026+7% Output

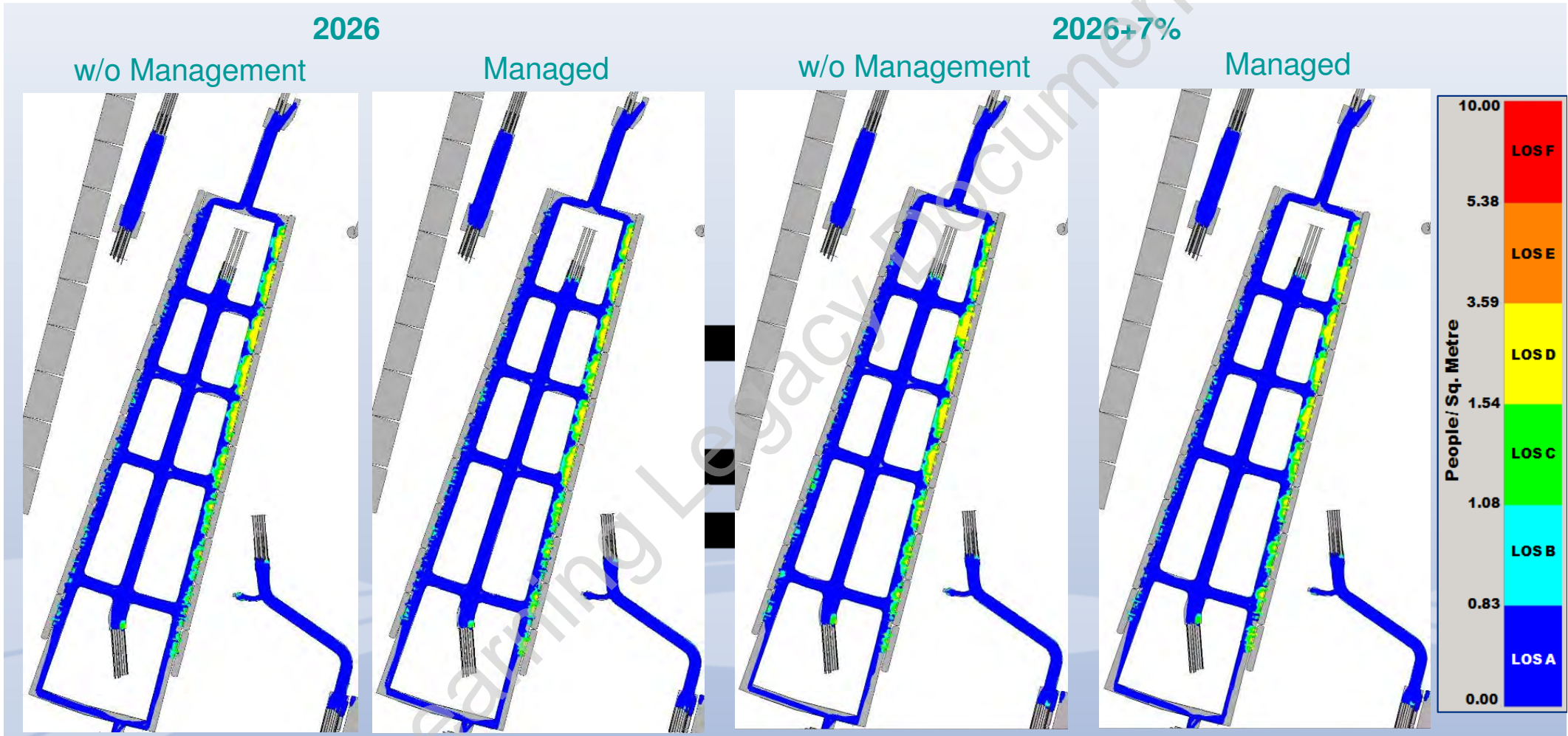

CMD - Queuing LOS (17:45-18:00)

Crossrail Platforms and Passageways AP2 and AP9 2026 and 2026+7% Output

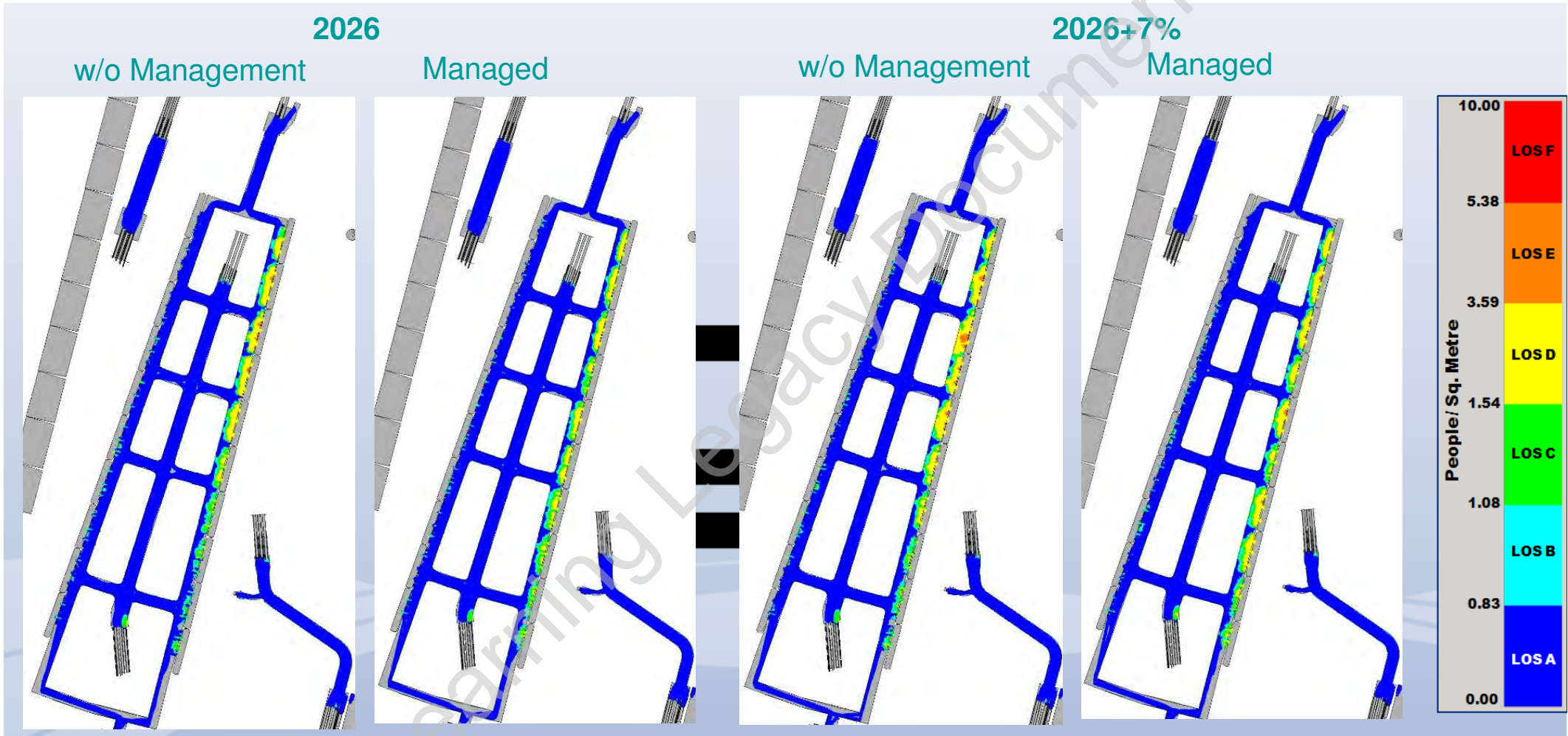

CMD - Queuing LOS (18:00-18:15)

Crossrail Platforms and Passageways AP2 and AP9 2026 and 2026+7% Output

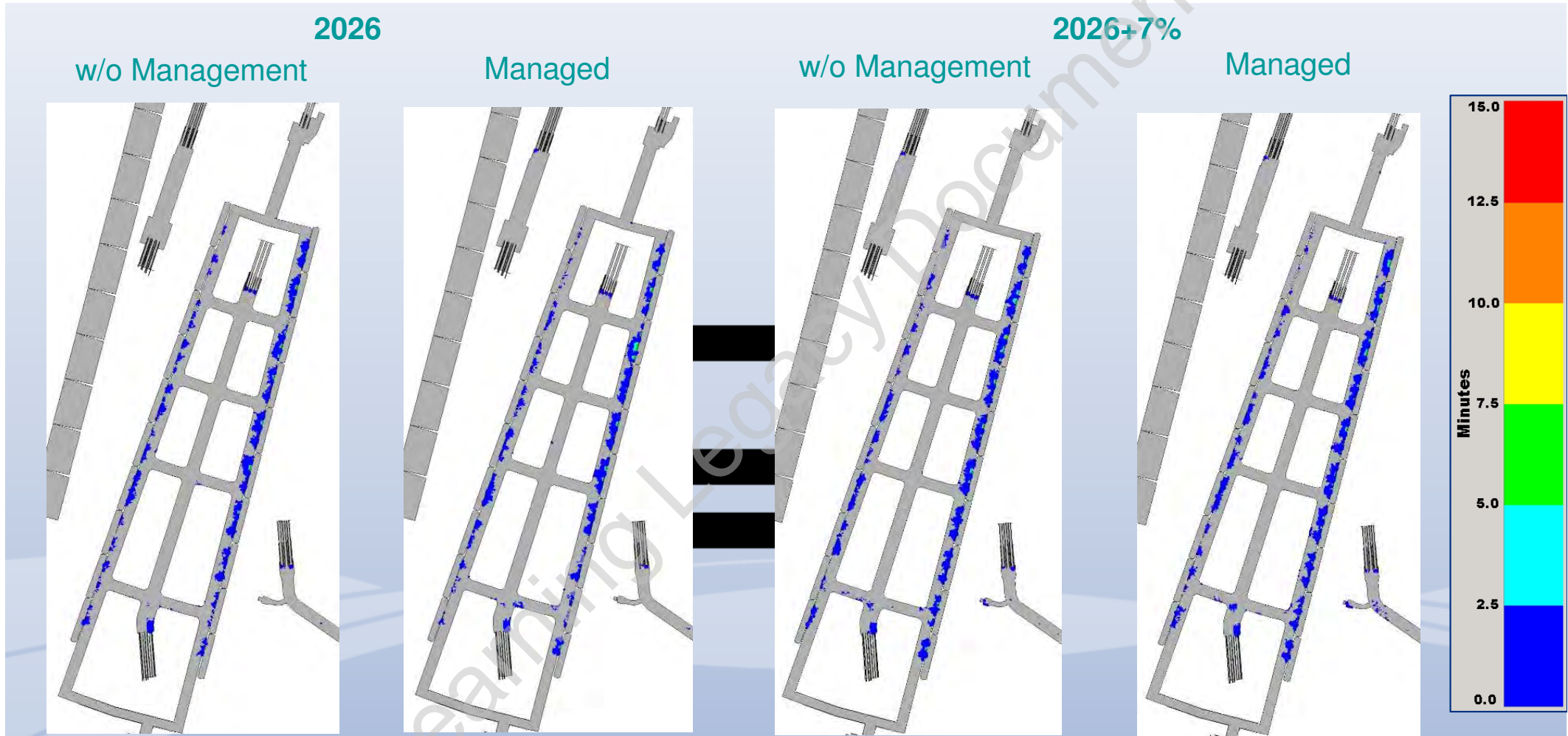

CHD - greater than Queuing LOS C (17:30 -17:45)

Crossrail Platforms and Passageways AP2 and AP9 2026 and 2026+7% Output

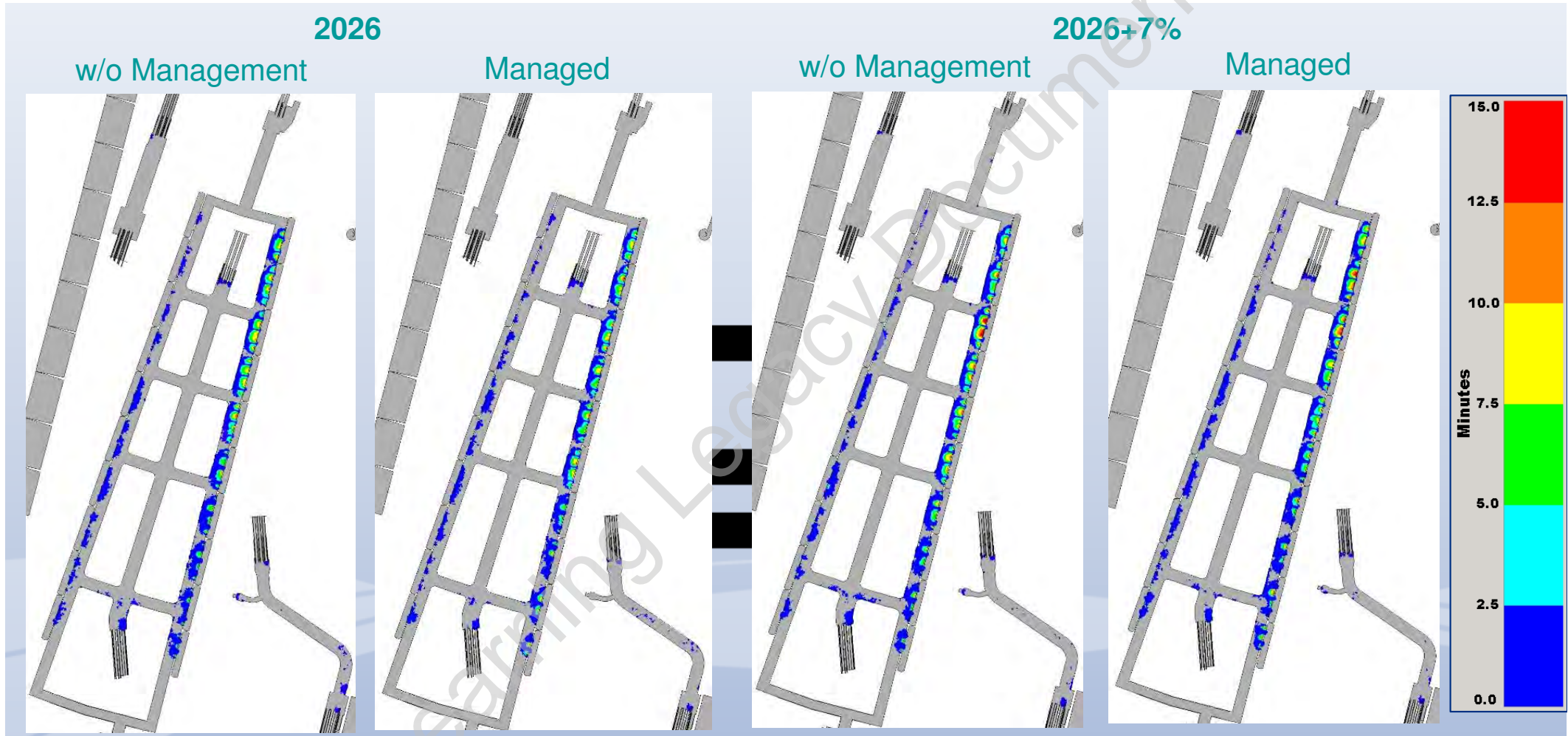

CHD - greater than Queuing LOS C (17:45-18:00)

Crossrail Platforms and Passageways AP2 and AP9 2026 and 2026+7% Output

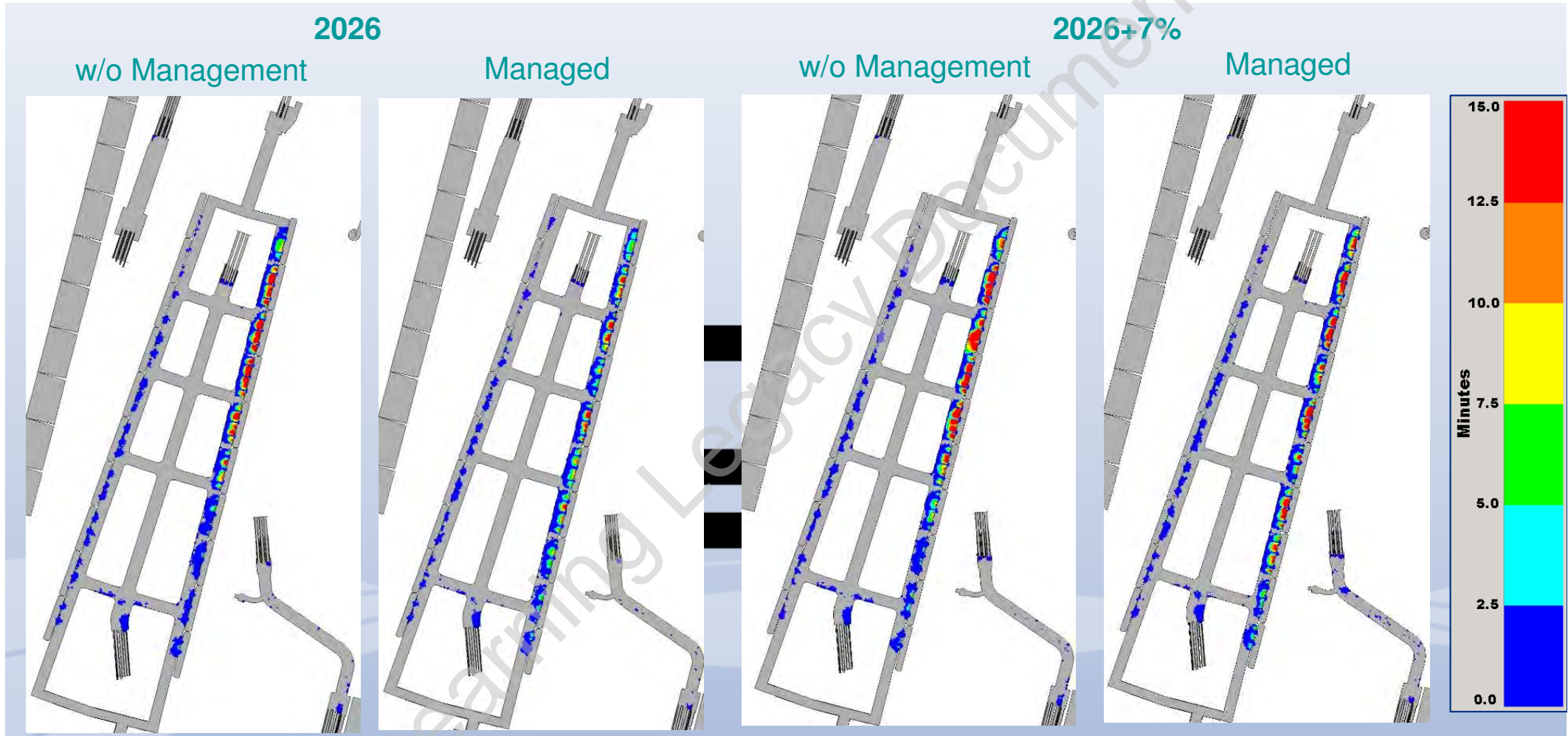

CHD - greater than Queuing LOS C (18:00-18:15)

Crossrail Platforms and Passageways AP2 and AP9

2026+14% Output

- The following slides are a snapshot at the approximate time the 2026+14% models with and without Management fail due to overcrowding which prevented the model from being able to complete.



Crossrail Platforms and Passageways AP2 and AP9 2026+14% without Management



Snapshot at 18:00 - passenger circulation breakdowns and simulation fails.

Crossrail Platforms and Passageways AP2 and AP9 2026+14% with Management



Snapshot at 18:00 - passenger circulation breakdowns and simulation fails.

Crossrail Platforms and Passageways AP2 and AP9

2026+21%

- The following slide is a snapshot of when the 2026+21% model with Management fails due to overcrowding.
- The model for 2026+21% without management has not been run since the 2026+14% with management scenario failed.



Crossrail Platforms and Passageways AP2 and AP9 2026+21% with Management



Snapshot at 17:56 - passenger circulation breakdowns and simulation fails.

Summary of Simulation Outputs for Breakpoint Tests

- The following table summaries:
 - When boarders are first 'left behind' (i.e. unable to board a train).
 - The time at which management of passengers is first required based on the overcrowding threshold of 145 people per carriage (i.e. 1.62 p/m²).
 - Whether the simulation was able to complete, and if not, when did it fail due to overcrowding.

| | 2026 | 2026+7% | 2026+14% | 2026+21% |
|---|----------|----------|---------------|---------------|
| Time at which boarders are left on platform | 17:57:30 | 17:37:00 | 17:37:00 | 17:32:00 |
| Start of Management scenario | 17:58:40 | 17:56:40 | 17:52:00 | 17:44:00 |
| Simulation status at 19:00 | Complete | Complete | Fail at 18:00 | Fail at 17:56 |

Crossrail Platforms and Passageways AP2 and AP9 Management Activation Timeline

- The following graph illustrates when staff management is required, when the cancelled train occurs, and whether the model fails.

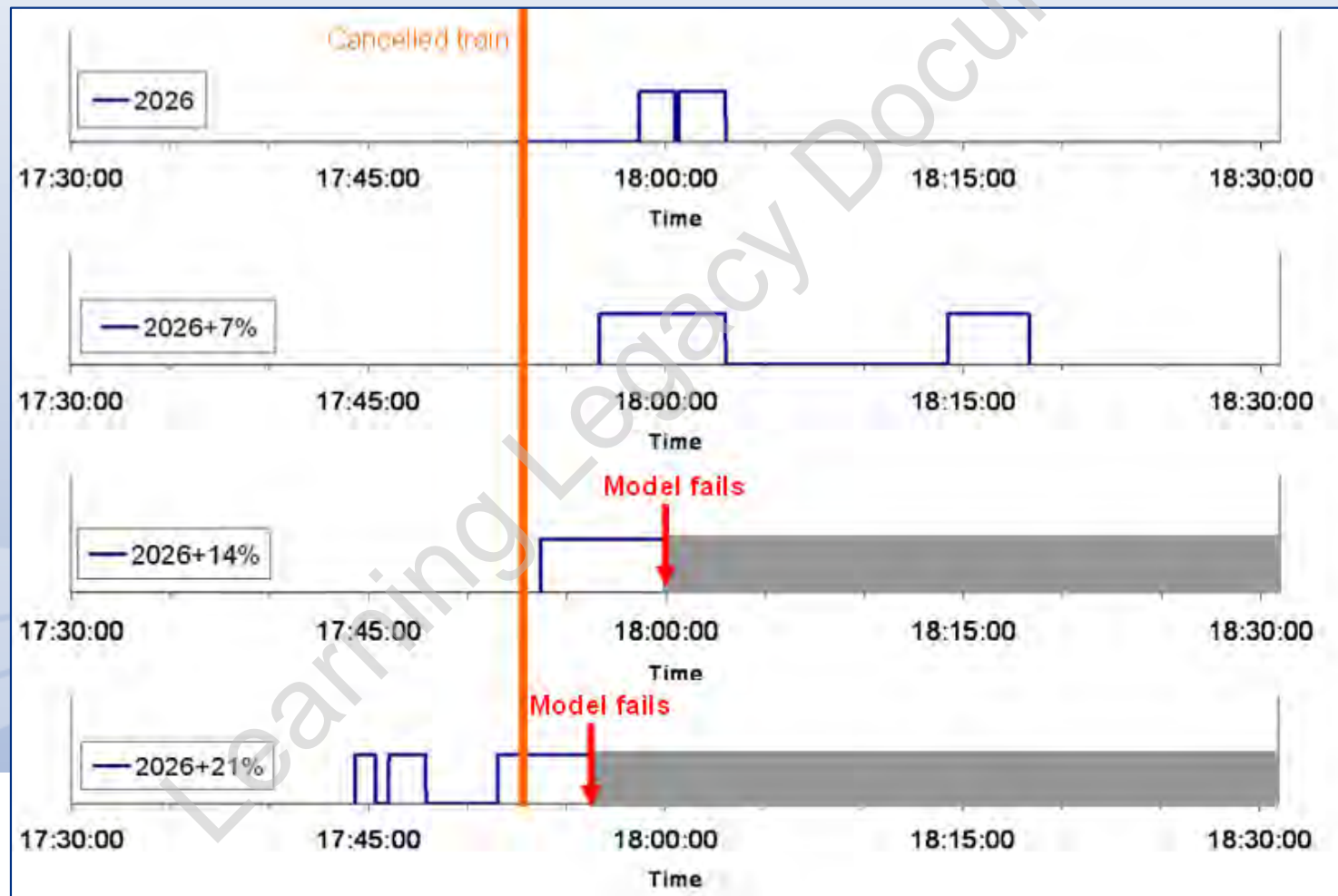

- Summary of modelling findings:
 - 1) The threshold of overcrowding (145 passengers waiting for any one carriage, equivalent to 1.62 p/sqm) was exceeded for all four demand scenarios (2026 – 2026+21%).
 - 2) Management scenario 1 always triggers management scenario 2.
 - 3) Before the cancelled train (17:52:00), from the 2026+7% demand scenario onwards boarders are left on the platform.
 - 4) Irrespective of management scenarios 1 & 2, based on 2026+14% and 2026+21% demand the models fail due to overcrowding around within CP5 (i.e. 3rd adit from Moorgate end of the station).
 - 5) In 2026+21%, management kicks in before the cancelled train.

Document control Sheet

| | | | |
|--------------------------|---|--------------|-------------------|
| Project title: | C138 Liverpool Street Station | | |
| MM project number: | 266429 | | |
| Document type: | Report | | |
| Directory & file name: | http://pims01/pims/llisapi.dll/Open/1471173537 | | |
| Document Approval | | | |
| Primary author: | Sonja Le Bail | | |
| Other author(s): | | | |
| Reviewer(s): | Christian Castle | | |
| Formatted by: | Sonja Le Bail | | |
| Distribution | | | |
| Issue | Date | Distribution | Comments |
| 1.0 | 07/03/2011 | Crossrail | Issue for review. |



Appendix F: Dynamic Passenger Modelling Output – Totems

Learning Legacy Document



C138: Liverpool Street Station

Dynamic Passenger Modelling Output – Totems

Scope and Purpose

- The purpose of this study has been to assess the impact of the proposed totems on the circulation of passengers within the Crossrail central concourse.
- Dynamic Legion passenger modelling of Liverpool Street station has been undertaken to assess the movement of passengers within the central concourse during the busiest period of the AM (08:00-09:30) and PM peaks (17:15-18:45).
- The model simulates a normal operational condition of the station, with a non-perturbed train service (i.e. no cancelled train), during the 2026 and 2026+28% demand years.

Model Configuration

[Redacted]
[Redacted]

Station design with Column Lighting

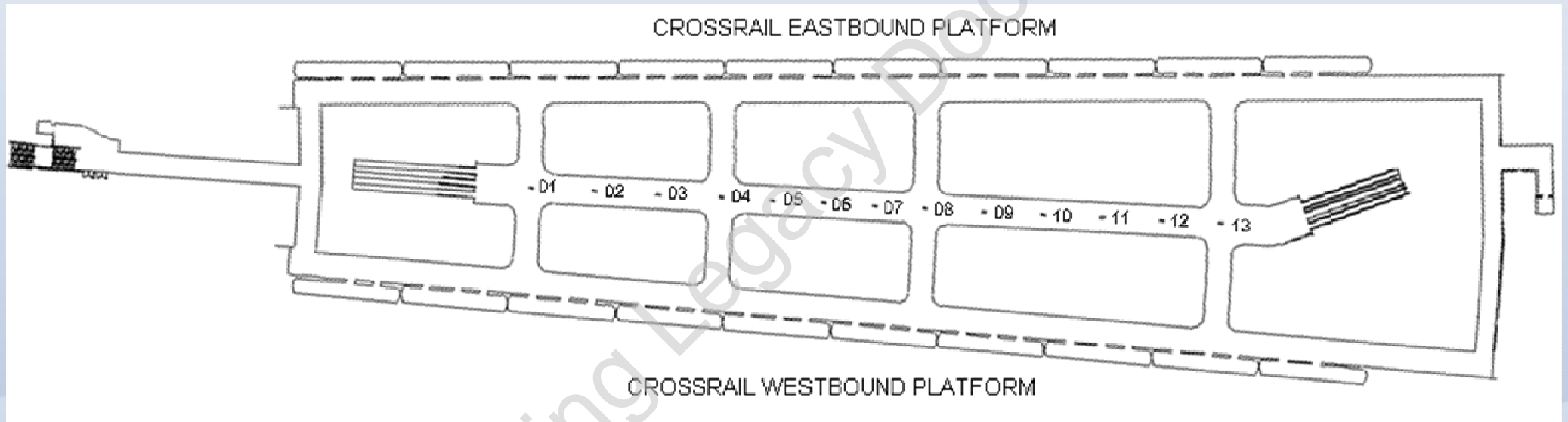

Results and Outputs

[Redacted]
[Redacted]

Learning Legacy Document

Base Models and Revised Models

- The Legion base models were:
 - 2026 AM peak: LIV 2026 0800-0930 AM PRM lift v08c.lgm
 - 2026 PM peak: LIV 2026 1715-1845 PM PRM lift no MS no canc'd v14c.lgm
 - 2026+28% AM peak: LIV 2026+28% 0800-0930 AM PRM lift v10c.lgm
 - 2026+28% PM peak: LIV 2026+28% 1715-1845 PM PRM lift no MS no canc'd v13c.lgm
- The final models developed by the FDC, which have been used to undertake this present study are:
 - 2026 AM peak: LIV 2026 0800-0930 AM PRM lift v08c poles.lgm
 - 2026 PM peak: LIV 2026 1715-1845 PM PRM lift no MS no canc'd v14c poles.lgm
 - 2026+28% AM peak: LIV 2026+28% 0800-0930 AM PRM lift v10c poles.lgm
 - 2026+28% PM peak: LIV 2026+28% 1715-1845 PM PRM lift no MS no canc'd v13c poles.lgm

Results

- The modelling has been undertaken using Legion Studio (EP 5), in accordance with the Crossrail Pedestrian Modelling Guidelines (CR/QMS/OPS/GN/0010).
- The following output maps have been generated for the peak 15 minutes of the AM and PM periods:
 - Cumulative Mean Density (CMD), Fruin Walkway Level of Service. These maps illustrate the density experienced by each passenger, for every time step, averaged by location
 - Space Utilisation

Assessment Criteria

- Based on the passenger modelling output, the operational performance of the station has been assessed against the criteria defined within the Crossrail Pedestrian Modelling Guidelines (CR/QMS/OPS/GN/0010). Accordingly, the guidelines refer to the LU - Station Planning Standard (1-371-A4), and / or the overarching Crossrail Station Planning Standard – Platforms (CR-STD-305, version 8.0). It requires that passenger density during the peak 15 minute period satisfies the following criteria:
 - Walkway Level of Service (LOS) C or better in the circulation areas.
 - Queuing Level of Service (LOS) C or better in queuing areas for ticket hall facilities, and waiting / accumulation areas for platforms.
 - Queuing Level of Service (LOS) B or better in open concourse areas.
- The Crossrail modelling guidelines state that a platform assessment should be predominantly based on the Queuing LOS, but where the predominant platform activity is movement Walkway LOS should be used (e.g. around an adit).

AM Peak Period



Crossrail Platforms 2026 and 2026+28% Output

AM 2026

No Totems

With Totems

AM 2026+28%

No Totems

With Totems

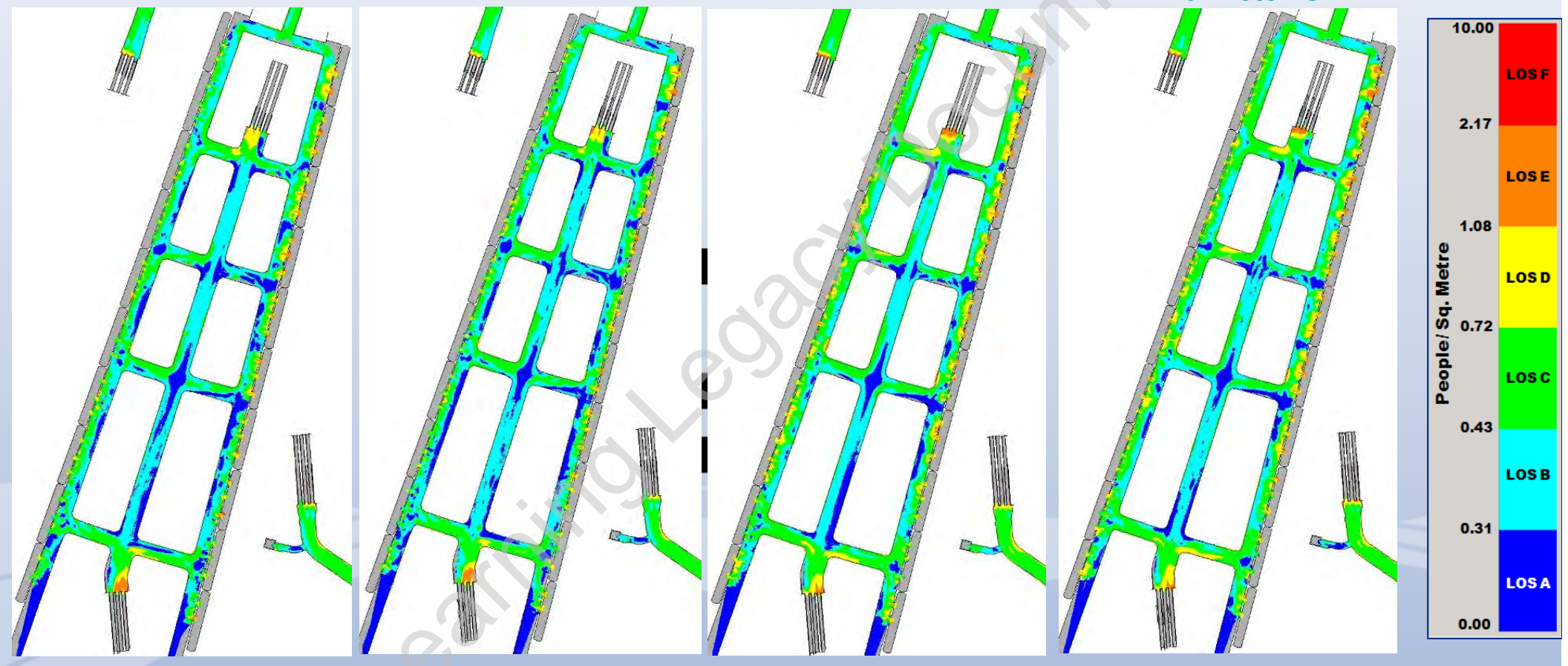

CMD - Walkway LOS (08:45-09:00)

Crossrail Platforms 2026 and 2026+28% Output

AM 2026

No Totems

With Totems

AM 2026+28%

No Totems

With Totems

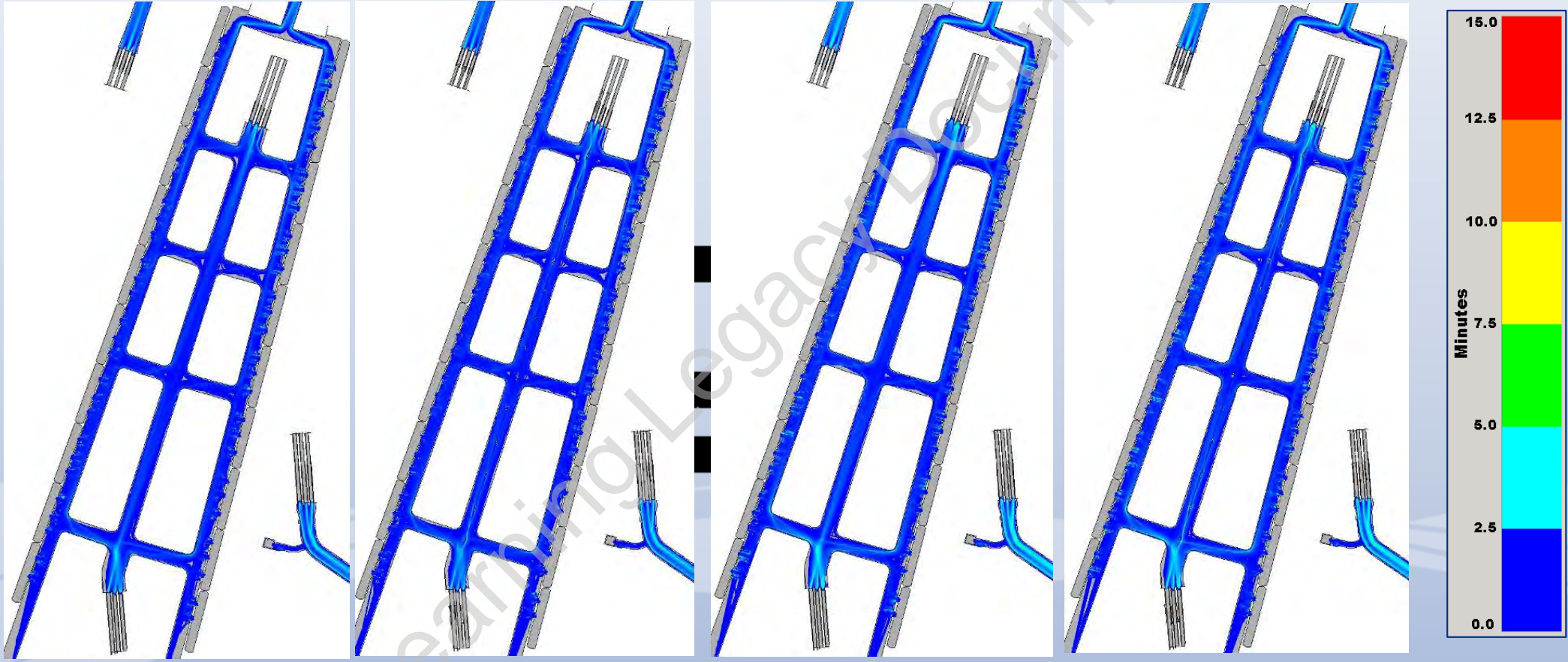

Space Utilisation (08:45-09:00)

PM Peak Period

[Redacted]
[Redacted]

Crossrail Platforms 2026 and 2026+28% Output

PM 2026

No Totems

With Totems

PM 2026+28%

No Totems

With Totems

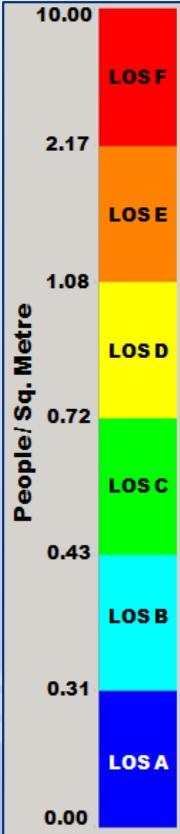
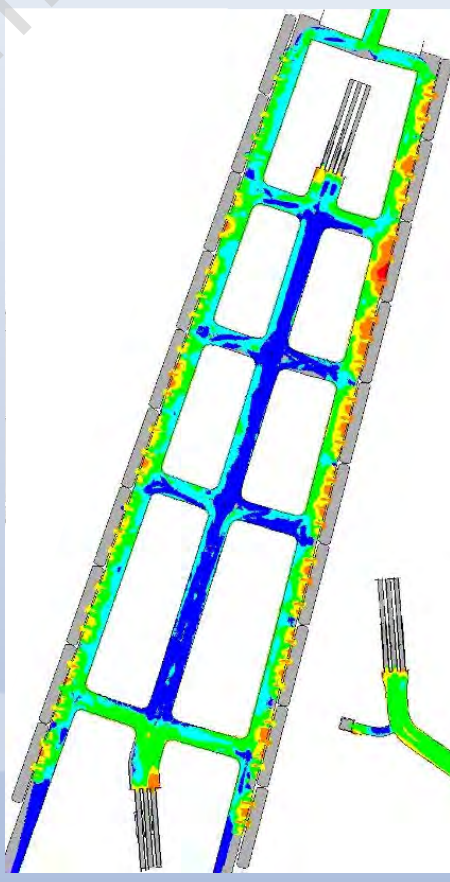
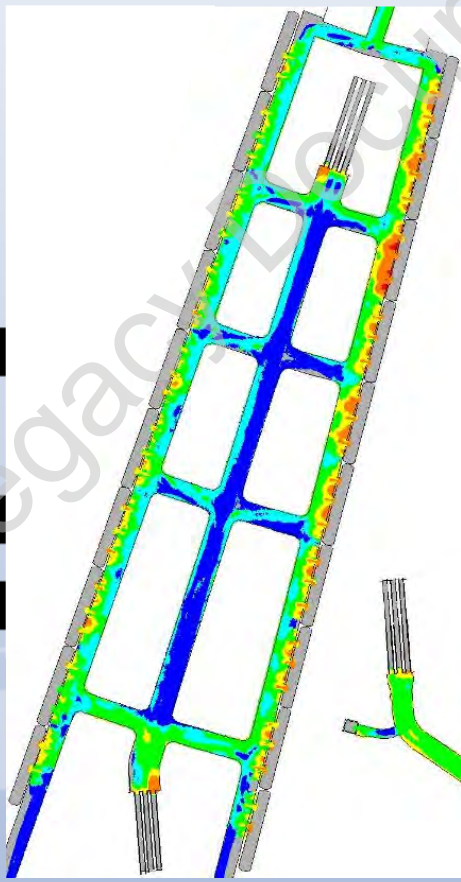
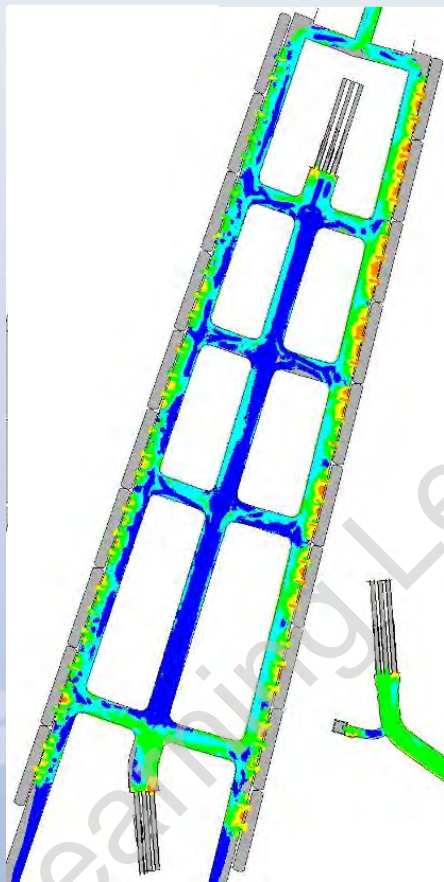
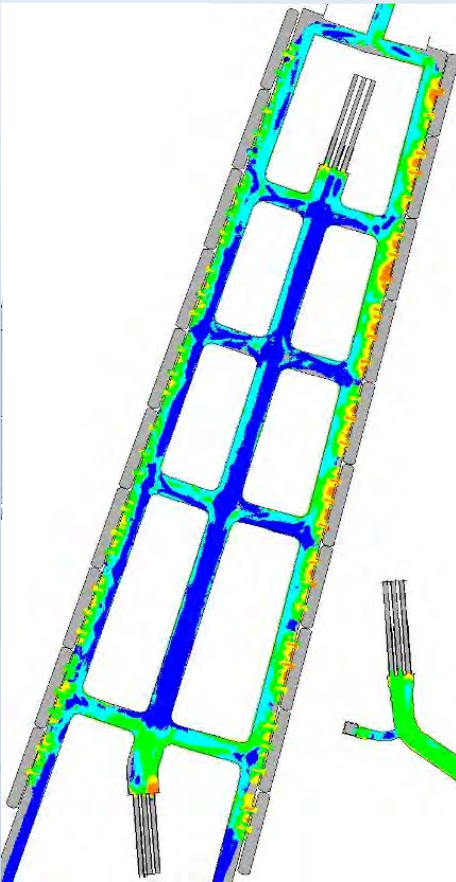

CMD - Walkway LOS (17:45-18:00)

Crossrail Platforms 2026 and 2026+28% Output

PM 2026

No Totems

With Totems

PM 2026+28%

No Totems

With Totems

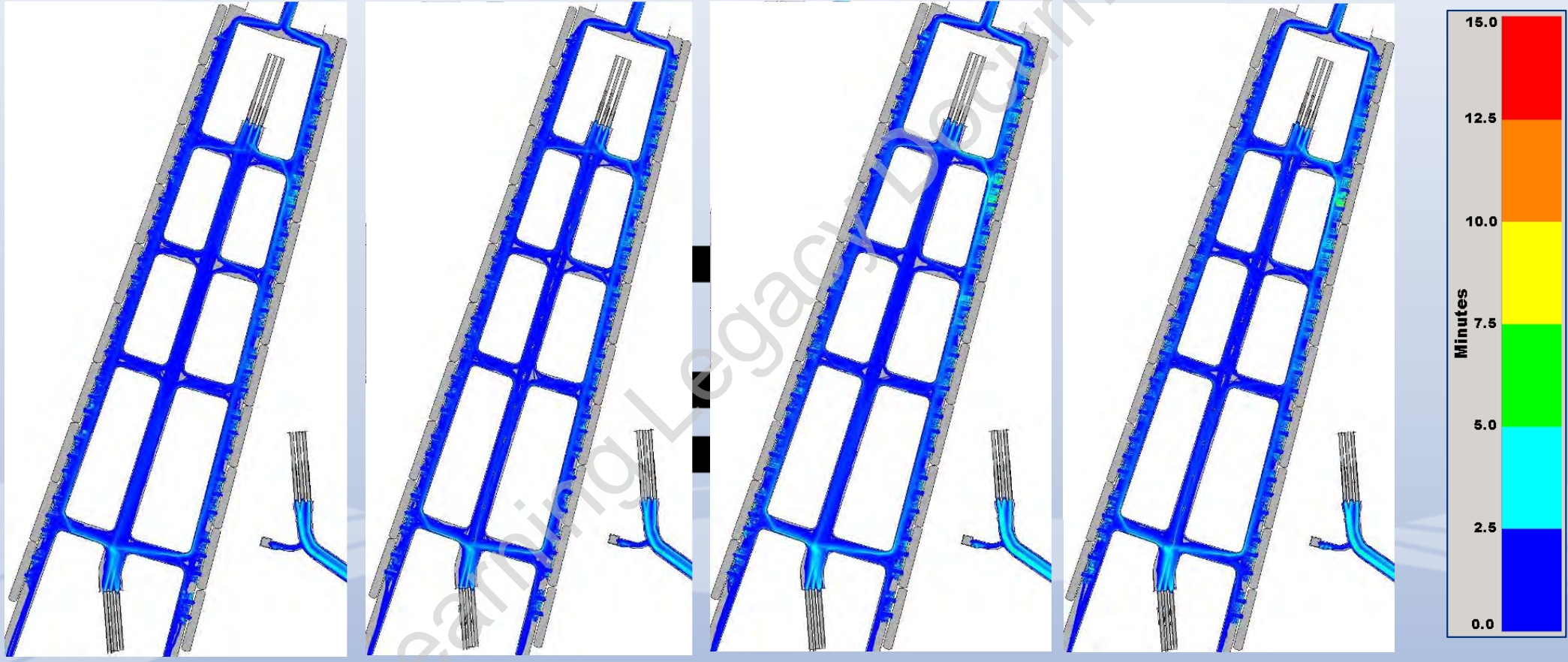

Space Utilisation (17:45-18:00)

Document control Sheet

| | | | |
|--------------------------|---|--------------|-------------------|
| Project title: | C138 Liverpool Street Station | | |
| MM project number: | 266429 | | |
| Document type: | Report | | |
| Directory & file name: | http://pims01/pims/llisapi.dll/Open/1471175707 | | |
| Document Approval | | | |
| Primary author: | [REDACTED] | | |
| Other author(s): | | | |
| Reviewer(s): | [REDACTED] | | |
| Formatted by: | [REDACTED] | | |
| Distribution | | | |
| Issue | Date | Distribution | Comments |
| 1.0 | 07/03/2011 | Crossrail | Issue for review. |